

Infoprint Server for iSeries



# User's Guide

*Version 5, Release 4.0*



Infoprint Server for iSeries



# User's Guide

*Version 5, Release 4.0*

**Note**

Before using this information and the product it supports, be sure to read the general information in "Notices" on page 219.

**Sixth Edition (February 2006)**

This edition applies to the IBM Infoprint Server for iSeries Version 5 Release 4 Modification 0 licensed program, Program Number 5722-IP1, and to all subsequent releases and modifications until otherwise indicated in new editions or technical newsletters. Be sure to use the correct edition for the level of the product.

Order publications through your IBM representative or the IBM branch office serving your locality. Publications are not stocked at the address given below.

The IBM Printing Systems Division welcomes your comments. A form for reader's comments is provided at the back of this publication. If the form has been removed, you may send your comments to the following address:

INFORMATION DEVELOPMENT  
THE IBM PRINTING SYSTEMS DIVISION  
DEPARTMENT H7FE BUILDING 004M  
PO BOX 1900  
BOULDER CO 80301-9191  
U.S.A.

If you prefer to send comments electronically, use one of the following methods:

- Internet: [printpub@us.ibm.com](mailto:printpub@us.ibm.com)
- Fax: 1-800-524-1519 or 1-303-924-6873

**Internet**

Visit our home pages at <http://www.ibm.com/printers>  
and <http://www.ibm.com/servers/eserver/iserries/>.

When you send information to IBM, you grant IBM a nonexclusive right to use or distribute the information in any way it believes appropriate without incurring any obligation to you.

© Copyright International Business Machines Corporation 2001, 2006. All rights reserved.

US Government Users Restricted Rights – Use, duplication or disclosure restricted by GSA ADP Schedule Contract with IBM Corp.

# Contents

Figures . . . . .	v
-------------------	---

## About Infoprint Server for iSeries: User's Guide (G544–5775) . . . . . vii

Who Should Read this Publication . . . . .	vii
Conventions and Terminology Used in This Publication . . . . .	viii
Understanding Syntax Notation . . . . .	viii
Prerequisite and Related information . . . . .	ix
Program Fixes . . . . .	x

## Summary of Changes . . . . . xi

## Chapter 1. Introducing Infoprint Server 1

How Infoprint Server Fits in with i5/OS Printing . . . . .	1
What's New in Infoprint Server Version 5.3? . . . . .	6
Installing Infoprint Server . . . . .	7

## Chapter 2. Using the Create AFP Data (CRTAFPDTA) Command . . . . . 9

Overview of CRTAFPDTA . . . . .	9
Syntax . . . . .	11
Planning for CRTAFPDTA . . . . .	13
Authorities . . . . .	13
Indexing with CRTAFPDTA . . . . .	14
Indexing with Data Values . . . . .	15
Indexing with Literal Values . . . . .	15
Indexing Limitations . . . . .	15
Retrieving Resources . . . . .	16
How CRTAFPDTA Searches for AFP Resources . . . . .	16
CRTAFPDTA Parameters . . . . .	17
CRTAFPDTA Examples . . . . .	28
Merging Resources with Data . . . . .	28
Indexing with CRTAFPDTA . . . . .	29
E-mailing the CRTAFPDTA Output . . . . .	34
How it Works . . . . .	34
Steps to E-mail the Output . . . . .	34
Example . . . . .	35
E-mail Considerations . . . . .	36
CRTAFPDTA and ACIF . . . . .	36

## Chapter 3. Transforming Image Data to AFP . . . . . 39

Syntax . . . . .	39
Overview of xxxx2afp . . . . .	39
Output Data Types . . . . .	40
Scaling . . . . .	40
Halftoning . . . . .	41
Installing the Image Transforms . . . . .	41
Planning for xxxx2afp . . . . .	41
Setting up a Configuration File . . . . .	42
Using Environment Variables . . . . .	42
Editing Your Windows Path . . . . .	43
Authorities . . . . .	43

Parameters . . . . .	44
Transforming Image Data to AFP . . . . .	54
Input to the Image to AFP Transform . . . . .	54
Specifying the Output File . . . . .	55
Invoking the Image Transform . . . . .	55
Command Line Arguments . . . . .	55
Examples . . . . .	55
Error Recovery . . . . .	56
Limitations . . . . .	57
Acknowledgments . . . . .	57

## Chapter 4. Using the PDF Subsystem 59

Overview . . . . .	59
Default Transform Characteristics . . . . .	62
Before Using the PDF Subsystem . . . . .	63
QSPLJOB Authority Requirements . . . . .	63
Setting up Your PSF Configuration Object . . . . .	63
Configuring the Device . . . . .	64
Varying the Device ON . . . . .	65
Starting the Writer . . . . .	65
Transforming a Spooled File to PDF . . . . .	65
Example . . . . .	66
Accessing the PDF Subsystem with iSeries Access . . . . .	67
How Do I... . . . .	68
Include Images that are Not in a Page Segment . . . . .	68
Specify Intelligent Routing . . . . .	69
Respool a Spooled File as AFP . . . . .	70
Specify a PDF Administrator . . . . .	71
Specify Encryption and Password Protection for a PDF File . . . . .	72
Set the Public Authority Level for a PDF File . . . . .	73
Specify the Public Authority to the PDF Directory . . . . .	74
Name a PDF File and Specify its Location . . . . .	75
Insert Routing Tags into the Data . . . . .	76
PSF Configuration Object Parameters . . . . .	82
Usage Notes . . . . .	91
Object Containers . . . . .	91
IOCA, BCOCA, and GOCA Objects . . . . .	91
Bar Codes . . . . .	91
Color . . . . .	92
Error Checking . . . . .	92
Find Function . . . . .	92
Fonts . . . . .	92
Other Unsupported IPDS Functions . . . . .	93
Output File Size . . . . .	93
Page Numbering . . . . .	94
Printing Considerations . . . . .	94
Use of Printer Features . . . . .	94
Viewing Considerations . . . . .	95
PDF Conversion Completion Data Queue . . . . .	95
Using the Data Queue . . . . .	96
Format . . . . .	96
Error Recovery . . . . .	98
Messages . . . . .	98
Troubleshooting . . . . .	99

<b>Chapter 5. Map Objects . . . . .</b>	<b>103</b>
Overview of Map Objects . . . . .	103
Creating a Map Object . . . . .	104
Create PDF Map Command . . . . .	104
Example of Creating a Map Object . . . . .	105
Working with PDF Map Entries . . . . .	106
Displaying or Printing a Map Object . . . . .	142
Deleting a Map Object . . . . .	143
Using a Map Object . . . . .	143
Using a Map Object Created on OS/400 5.2 . . . . .	144
Example . . . . .	144
Error Situations. . . . .	148
<b>Chapter 6. Sending E-mail . . . . .</b>	<b>149</b>
Steps to Send a PDF File as E-mail . . . . .	150
Enabling Your i5/OS to Send E-Mail . . . . .	150
Steps to Enable Your i5/OS to Send E-mail . . . . .	151
Setting up the i5/OS as a POP E-mail Client . . . . .	153
Creating a PSF Configuration Object. . . . .	153
Using Routing Tags . . . . .	153
Inserting a Routing Tag in the Printer File . . . . .	154
Inserting a Routing Tag in the Spooled File . . . . .	154
Inserting a Routing Tag in the Input File . . . . .	155
Using AFP Manager to Send E-mail . . . . .	155
Before You Begin . . . . .	155
Steps to Create a PDF File and Send it as E-mail . . . . .	156
Checking for Non-delivery Messages . . . . .	156
Setting up a POP3 Client for a SNDDST Sender . . . . .	157
Setting QUTCOFFSET . . . . .	157
<b>Chapter 7. Transforming PCL, PDF, and PostScript Data to AFP . . . . .</b>	<b>159</b>
Overview. . . . .	159
Syntax. . . . .	160
Planning for the PCL, PDF, or PostScript to AFP Transforms . . . . .	161
Authorities . . . . .	161
System Requirements. . . . .	161
Creating the Work Directory . . . . .	161
Configuring Transform Manager . . . . .	162
Customizing the PostScript to AFP and PDF to AFP Transforms . . . . .	164
Starting and Ending Transform Manager . . . . .	166
Setting Up the Printer Device Description . . . . .	166
Transforming Data . . . . .	167
Deactivating and Reactivating the Transforms . . . . .	167
Steps to Deactivate the Transforms . . . . .	167
Reactivating the Transforms . . . . .	168
Font Downloader . . . . .	169
Syntax. . . . .	169
Troubleshooting . . . . .	171
<b>Chapter 8. Related Products . . . . .</b>	<b>173</b>

iSeries Access . . . . .	173
Overview. . . . .	173
iSeries Access for Web . . . . .	173
Infoprint Designer for iSeries . . . . .	174

**Appendix A. Related Tasks . . . . . 175**

Turning a PC AFP Resource into an i5/OS Resource . . . . .	175
--	-----

**Appendix B. Mapping Program . . . . . 177**

Changes to the PDF Mapping Program. . . . .	178
Dependencies Between Mapping Program Values and PSF Configuration Object Values . . . . .	179
Parameters . . . . .	179
Mapping Program Input information . . . . .	180
Mapping Program Output . . . . .	182
Extension Area Format . . . . .	185
Stream File Format . . . . .	191
Individual Stream File Information Format . . . . .	192
Spooled File PDF Distribution Format . . . . .	193
Spooled File AFPDS Distribution Format . . . . .	194
PDF Encryption Format . . . . .	195
Troubleshooting the PDF Mapping Program . . . . .	198
PDF Mapping Program Reason Codes . . . . .	198
Diagnostic Spooled File . . . . .	200

**Appendix C. Templates . . . . . 209**

PDF Mapping Program in C . . . . .	209
PDF Mapping Program in RPG . . . . .	212
Code license disclaimer information . . . . .	216

**Appendix D. Exit Points . . . . . 217**

**Notices . . . . . 219**

Programming Interface Information . . . . .	221
Trademarks . . . . .	221

**Glossary . . . . . 223**

**Bibliography. . . . . 231**

Infoprint Server . . . . .	231
Advanced Function Presentation (AFP). . . . .	231
Infoprint Designer. . . . .	231
i5/OS . . . . .	231
Printers . . . . .	232
Redbooks. . . . .	232
TCP/IP . . . . .	232

**Index . . . . . 233**

---

## Figures

1. i5/OS syntax example . . . . .	ix	33. Specifying the Mapping Actions . . . . .	140
2. iSeries Printing without Infoprint Server . . . . .	2	34. Specifying E-mail Information - First Panel, General Information . . . . .	140
3. iSeries Output Management with Infoprint Server. . . . .	5	35. Specifying E-mail Information - Second Panel, General Information . . . . .	141
4. Infoprint Server Components . . . . .	6	36. Specifying E-mail Information - Third Panel, Files for E-mail Body . . . . .	141
5. Using CRTAFPDTA . . . . .	10	37. Specifying E-mail Information - Fourth Panel, E-mail Attachments . . . . .	141
6. CRTAFPDTA command syntax . . . . .	12	38. Specifying E-mail Information - Fifth Panel, PDF Encryption Options . . . . .	142
7. AFP Document with Index Tags and the Index Object File . . . . .	14	39. Specifying AFP Spooled File Information	142
8. Example CRTAFPDTA Command . . . . .	28	40. Work with PDF Map Entries Panel with One Entry . . . . .	142
9. Example of a Customer's Phone Bill . . . . .	30	41. Displaying a PDF Map . . . . .	143
10. Example Telephone Bill Input File . . . . .	31	42. DDS Coding for File Segmentation . . . . .	145
11. Example CRTAFPDTA Command . . . . .	32	43. Adding an Entry for the Northwest Region	146
12. xxxx2afp command syntax . . . . .	39	44. Add Segment Entry for Northwest Region	146
13. Transforming a Spooled File to PDF . . . . .	60	45. Specifying the Mapping action for the Northwest Segment . . . . .	146
14. Routing Tags . . . . .	61	46. Specifying E-mail Addresses for Northwest report . . . . .	147
15. Specifying STRPAGGRP and ENDPAGGRP	77	47. Specifying AFP Respool Parameters for the Northwest Report . . . . .	147
16. Creating a PDF Map Object . . . . .	106	48. Specifying PDF Stream File Parameters for the Northwest Report . . . . .	147
17. Work with PDF Map Entries Command Flow	107	49. Transforming PCL, PDF, and PostScript data to AFP Data. . . . .	160
18. Work PDF Map Entry Command Display	108	50. Starting Transform Manager . . . . .	160
19. Define PDF Map Action Panel . . . . .	111	51. Ending Transform Manager . . . . .	160
20. Change PDF Map Entry - First Panel	117	52. Default Configuration File . . . . .	163
21. Display PDF Map Entry, First Panel . . . . .	118	53. Font Downloader Process . . . . .	169
22. Display PDF Map Entry - Second Panel	119	54. Starting Font Downloader . . . . .	170
23. Work with Segments Command Flow	121	55. Ending Font Downloader . . . . .	170
24. Add Segment Entry - Panel 1, Routing Tag	122		
25. Add Segment Entry Panel . . . . .	122		
26. Change Segment Entry Panel . . . . .	124		
27. Copy Segment Entry Panel . . . . .	124		
28. Display Segment Entry - First Panel . . . . .	125		
29. Display Segment Entry - Second Panel	125		
30. Work with PDF Map Entries Panel . . . . .	139		
31. Adding a PDF Map Entry . . . . .	139		
32. Specifying File Selection Criteria . . . . .	140		





---

## About Infoprint Server for iSeries: User's Guide (G544–5775)

This publication provides information about using IBM® Infoprint® Server for iSeries™ Version 5 Release 4 (licensed program number 5722-IP1), hereafter referred to as Infoprint Server.

You can use this publication both as a guide and as a reference to help you learn about the following:

- Chapter 1, "Introducing Infoprint Server," on page 1 gives an overview of this product and describes how it fits in with i5/OS printing.
- Chapter 2, "Using the Create AFP Data (CRTAFPDTA) Command," on page 9 describes how to use the CRTAFPDTA command.
- Chapter 3, "Transforming Image Data to AFP," on page 39 describes how to use the gif2afp, jpeg2afp, and tiff2afp commands.
- Chapter 4, "Using the PDF Subsystem," on page 59 describes how to transform a spooled file to the Portable Document Format (PDF) data stream
- Chapter 5, "Map Objects," on page 103 describes how to create and use a map object.
- Chapter 6, "Sending E-mail," on page 149 describes how to use Infoprint Server to e-mail PDF files.
- Chapter 7, "Transforming PCL, PDF, and PostScript Data to AFP," on page 159 describes how to transform Printer Control Language (PCL), PDF, and PostScript data to AFP™ format.
- Chapter 8, "Related Products," on page 173 describes how to use the AFP Viewer and iSeries Access in conjunction with Infoprint Server. It also describes iSeries Access for Web.
- Appendix A, "Related Tasks," on page 175 describes how to use i5/OS commands to turn an AFP resource on your PC into an i5/OS resource.
- Appendix B, "Mapping Program," on page 177 describes how to use the e-mail exit program and the PDF transform exit program in conjunction with Infoprint Server.
- Appendix C, "Templates," on page 209 contains templates for e-mail exit programs.
- Appendix D, "Exit Points," on page 217 lists the exit points that Infoprint Server registers.
- The Glossary contains terms and definitions related to PSF and the printing environment.
- The bibliography contains selected titles and order numbers of IBM publications related to PSF and the printing environment.

---

### Who Should Read this Publication

The information in this publication is directed at people in applications and operational functions that need to understand various functional components of Infoprint Server and how to implement them in their environment.

This publication is written with the assumption that you have experience with application programming and with Advanced Function Presentation™ (AFP) printers. It is also assumed that you are familiar with the system and using it to print.

---

## Conventions and Terminology Used in This Publication

The term i5/OS refers to the operating system of the iSeries. In this manual, the term AFP Viewer refers to both the AFP Workbench Viewer, available with iSeries Access, and the AFP Viewer Plug-in, available as a free download from IBM.

### Understanding Syntax Notation

The following rules apply to coding illustrations and Windows® command syntax throughout this publication:

- Variable data is printed in italics. Enter specific data to replace the characters in italics. For example, for *ImageType* you could enter IM1. Italics also identify the names of publications.
- Bold highlighting identifies commands, keywords, files, directories, and other items whose names are predefined by the system, or items that must be entered as is, such as **-ink**.
- Monospacing, for example, `gf2afp` identifies examples of specific data values, examples of text similar to what you might see displayed, examples of portions of program code similar to what you might write as a programmer, messages from the system, or information you should actually type.
- Do not enter the following symbols as part of a parameter or option:
  - Vertical Bar |
  - Underscore \_\_\_\_
  - Brackets [ ]
  - Braces { }
  - Ellipsis ...
- A vertical bar between two values means that you select only one of the values. For example, `VALUE1 | VALUE2` means that you can choose either VALUE1 or VALUE2.
- An underscored value means that if an option is not specified, the underscored value, called the default, is used. For example, `Print (yes | no)` means that if you do not specify anything for Print, its value is set to yes.
- Brackets around a value mean that you do not have to select the value; the value is optional. For example, `File [library]` means you can specify the library but you do not have to.
- Braces around a value mean that you must select one of the mutually exclusive values. For example, `{ THIS | THAT }` means you must specify either THIS or THAT.
- An ellipsis following a command or set of commands indicates the command or set of commands can be repeated. For example, `Print (file...)` means that you can specify multiple values for *file*.

The following rules apply to i5/OS command syntax throughout this publication:

- Variable data is printed in italics. Enter specific data to replace the characters in italics. For example, for *indexing-page-limit* you could enter 50. Italics also identify the names of publications.
- Commands are printed in all upper case letters. They must be entered exactly as they appear.

- Values are enclosed in parenthesis, for example, *(file)*. Enter the parenthesis as part of the parameter.
- A command or keyword printed on the baseline is required. For example, in Figure 1, COMMAND and INPUT *(file)* are required, but A and B are optional.
- A value printed above the baseline is the default. For example, in Figure 1, \*DFT is the default value for the keyword A, but B does not have a default value.
- If values are printed above one another, you can choose only one of the values. For example, in Figure 1, you can choose \*DFT or *name* as the value for A.
- If values are printed next to each other, you can use all of the values. For example in Figure 1, you can enter either or both *val1* and *val2* as values of B.
- If values, commands, or keywords are printed with an arrow above them, you can repeat the part under the arrow. For example, in Figure 1, you can enter up to four values of *val1* and *val2* for B.

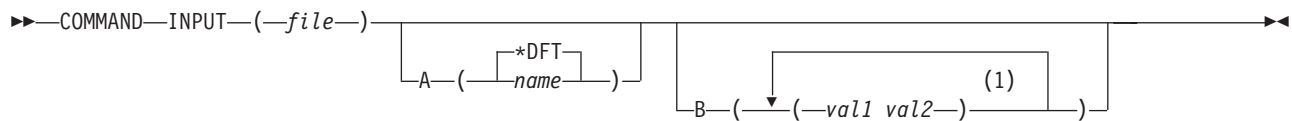

#### Notes:

- 1 A maximum of four repetitions.

Figure 1. i5/OS syntax example

## Prerequisite and Related information

Use the iSeries Information Center as your starting point for iSeries technical information.

You can access the Information Center two ways:

- From the following Web site:  
<http://www.ibm.com/eserver/iseries/infocenter>
- From the *iSeries Information Center*, SK3T-4091-04 CD-ROM. This CD-ROM ships with your new iSeries hardware or IBM i5/OS software upgrade order. You can also order the CD-ROM from the IBM Publications Center:  
<http://www.ibm.com/shop/publications/order>

The iSeries Information Center contains new and updated iSeries information such as software and hardware installation, Linux<sup>®</sup>, WebSphere<sup>®</sup>, Java<sup>™</sup>, high availability, database, logical partitions, CL commands, and system application programming interfaces (APIs). In addition, it provides advisors and finders to assist in planning, troubleshooting, and configuring your iSeries hardware and software.

With every new hardware order, you receive the *iSeries Setup and Operations CD-ROM*, SK3T-4098-02. This CD-ROM contains IBM eServer iSeries Access for Windows and the EZ-Setup wizard. iSeries Access Family offers a powerful set of client and server capabilities for connecting PCs to iSeries servers. The EZ-Setup wizard automates many of the iSeries setup tasks.

The Printing Systems iSeries Products Web page contains information about this product. See this Web page:

<http://www.ibm.com/printers/R5PSC.NSF/Web/as400overview>

For other related information, see the “Bibliography” on page 231.

## **Program Fixes**

To obtain the latest fixes to this program, go to the iSeries support Web page at <http://www-1.ibm.com/servers/eserver/support/series/index.html> and select Fixes.

---

## Summary of Changes

### Summary of Changes for Infoprint Server for iSeries: User's Guide, G544-5775-05.

This publication contains additions and changes to information that was previously presented in *Infoprint Server for iSeries: User's Guide*, G544-5775-04, which supports Infoprint Server for iSeries Version 5 Release 3.0. The technical additions are marked with a change bar ( | ) in the left margin.

These changes have been made throughout the publication:

- The current operating system for the iSeries is i5/OS. References to OS/400 have been removed as appropriate.
- The information in the *Printer Device Programming* manual has been put in the iSeries Information Center. References to the manual have been removed.
- The IBM AFP PrintSuite for iSeries (PrintSuite) product is no longer offered. PrintSuite was made up of these components:
  - Advanced Print Utility (APU) for iSeries. A complimentary version of the product is available as an unsupported download.
  - Page Printer Formatting Aid (PPFA) for iSeries. Infoprint Designer for iSeries is the replacement product.
  - AFP Toolbox for OS/400. A complimentary version of the product is available as an unsupported download.
  - SAP R/3 Print.

References to PrintSuite and its components have been removed.

The following information is new or updated:

- The description of rotation in the PDF subsystem has been changed. See "Viewing Considerations" on page 95 and "Troubleshooting" on page 99.
- A description for the Mail Sender value for the mapping program is described. See "Extension Area Format" on page 185.
- A new value has been added for PDF file public authority. See the description of Offset to PDF file public authority in the "Extension Area Format" on page 185.



---

## Chapter 1. Introducing Infoprint Server

IBM Infoprint Server for iSeries (hereafter referred to as Infoprint Server) is a separately orderable program for i5/OS. It provides essential electronic delivery options for iSeries along with the capabilities to consolidate network printing on the iSeries.

---

### How Infoprint Server Fits in with i5/OS Printing

Infoprint Server significantly expands the possibilities of print and electronic output in an iSeries environment, integrating new capabilities within the existing print framework. Let's take a closer look and see how. The existing output subsystem is generally print-centric. Figure 2 on page 2 depicts the flow within this subsystem. Any i5/OS application that creates print uses a printer file to provide job-level control information as the data is written to the output queue. DDS keywords can be used to define how application and static information is placed on each page. With these instructions, the application places print data (a spooled file) on an i5/OS output queue. The print data on the queue is usually either SCS (SNA Character Set) for simple line-mode output or AFP with graphics. With AFP print data, there are frequently embedded references to external print resources, such as fonts, overlays, and page segments.

Once the print data resides on the i5/OS output queue, there are three drivers that can route the print data to a printer. The driver is automatically selected based on the type of target printer. Base i5/OS print management includes the driver for printing to SCS printers. Host Print Transform is the driver for ASCII printers, principally PCL printers. When a PCL printer is selected by the print writer, the print file (either SCS or AFP) is passed to Host Print Transform. Host Print Transform then transforms the print data into ASCII and sends it to the printer. When an Intelligent Printer Data Stream™ (IPDS™) printer is started, Print Services Facility™ (PSF) for i5/OS is automatically invoked and interactively manages the entire printing process with the printer. When PSF for i5/OS manages AFP print data, it ensures that any external resources required, such as fonts, overlays, and images, are in printer memory when needed.

There are two additional types of external resources: page definitions and form definitions. These resources are a standard part of the AFP architecture and enable the pages to be formatted independently of the application program. Infoprint Designer for iSeries is a fully graphical output composition program that uses these resources to design new applications or re-engineer existing ones.

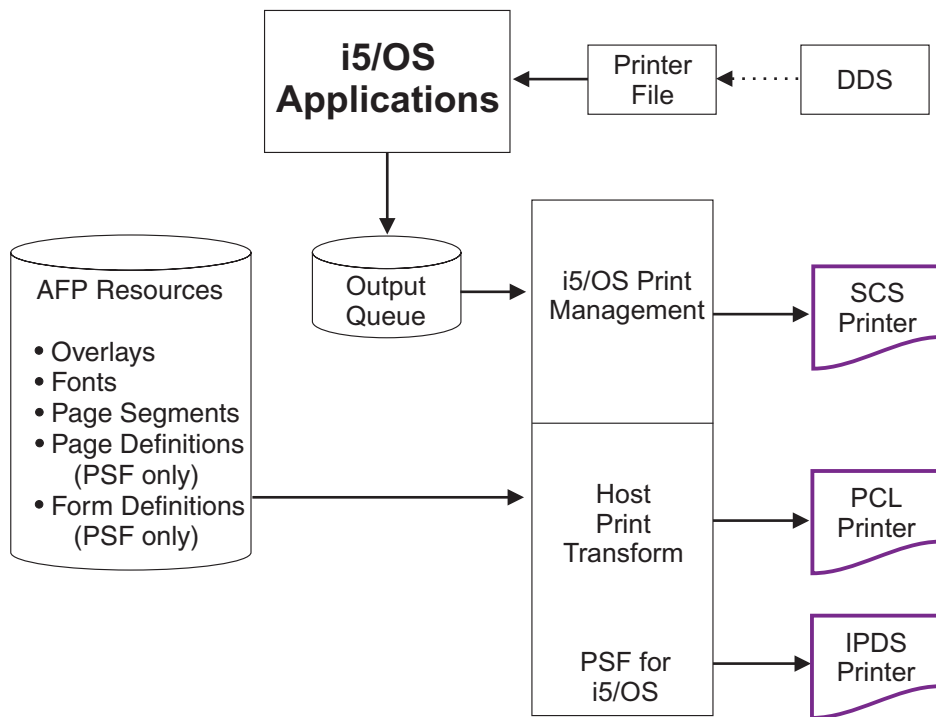

Figure 2. iSeries Printing without Infoprint Server

Infoprint Server opens up this print architecture. Figure 3 on page 5 shows the functional elements that Infoprint Server adds to the picture. The general focus is in two major areas: (1) projecting i5/OS output to the network, and (2) incorporating the network into the i5/OS print functions.

Infoprint Server has five functional components:

- PDF services for iSeries
- Intelligent Routing, including e-mail, Web, and file requeue
- Print file segmentation, AFP indexing, and portable AFP (Create AFP Data command)
- PDF, PostScript, and PCL to AFP data stream transforms (priced feature number 5101 for PostScript and PDF and 5102 for PCL)
- Image transforms for GIF, TIFF, and JPEG to iSeries format

Let's go through the Infoprint Server functional components one by one.

### PDF Services

A central component of Infoprint Server is the PDF subsystem. This subsystem enables the conversion of any standard i5/OS output data stream (SCS, AFP, IPDS, mixed data, line data, or even OfficeVision/400™ extended formats) to Adobe PDF. The transform creates a native, text-based ASCII PDF data file (assuming the input to the transform is a non-image print file). Highly integrated, the PDF subsystem is deployed as a virtual printer device. This facilitates seamless flow and the handling of the widest variety of input print formats.

Besides producing high-fidelity, text-based PDF, the PDF subsystem supports many advanced PDF features. PDF security functions such as encryption, password protection, and change protection can be selected. Advanced AFP page features, such as 2D bar codes and full color images, are supported in the PDF transform.



iSeries print file indexing, available through DDS or the Create AFP Data command, can be used in the created PDF as bookmarks.

iSeries print file indexing is used in another significant manner, for *segmentation*. Segmentation uses the electronic “triggers” placed in the print file by DDS or the Create AFP Data command to segment the print file. For example, a monthly sales report can be electronically segmented into regional report segments. In a hardcopy context, this is called “burst and bind”. Each segment is handled separately by the PDF subsystem, resulting in a separate PDF file being produced for each segment. The segmentation triggers can also contain key variable data that determines the routing or disposition of the segment. See *Intelligent Routing* for more information about working with segments.

There are a number of interface points with PDF services. PDF processing options can be defined in the printer file, the PDF mapping object, or a PDF exit program. This would be the normal, batch application flow. In addition, both iSeries Access and iSeries Access for Web have interfaces to PDF services. The Operations Navigator component of iSeries Access provides a set of interactive panels to define “ad hoc” PDF and intelligent routing operations. iSeries Access for Web uses the PDF subsystem to bring selected print files to the browser within Adobe Acrobat. There is also a copy spooled file Java method that can be used to build custom access to PDF services. For more information about the PDF Subsystem, see Chapter 4, “Using the PDF Subsystem,” on page 59.

### **Intelligent Routing**

Central to Infoprint Server is its “e-delivery” or routing capabilities. Working in conjunction with the PDF subsystem, print files or print file segments can be profiled, identified, transformed, and routed as required. A print file or print file segment can be converted to PDF and routed to e-mail, an integrated file system directory, or an output queue. In addition, a print file or print file segment can be re-queued in iSeries format (AFP) for other routing or delivery functions.

With Intelligent Routing, any combination of the transform and distribution options listed above can be applied to a print file or print file segment. Essential to this flow are the interfaces that provide the “action” information. Those interfaces include the application printer file, the PDF mapping object, and the PDF exit program. With the printer file, the User defined data parameter can be used to define action. With the PDF mapping object and the PDF exit program, the target print file or print file segment is identified and the desired action is defined. With segmented print files, the routing ID on each segment is used to drive the routing actions. The PDF mapping object is a data structure that is maintained by a set of iSeries commands. With the PDF mapping object, there is no programming required. With the PDF exit interface, the program communicates directly with the Intelligent Routing subsystem and provides the required “action” or delivery information. For more information about the PDF Subsystem, see Chapter 4, “Using the PDF Subsystem,” on page 59.

### **Indexing, Bookmarking, and Portable AFP**

PDF is one approach to electronic distribution of output, and is clearly the standard of Internet delivery. AFP is another standard, and is a natural for intranet delivery of output. The AFP Viewer is built into iSeries Access and an AFP Viewer plug-in is available for Netscape Navigator or Internet Explorer. Because AFP files can have external resources, it is essential that any AFP to be sent for viewing is sent with those external resources included. Infoprint Server provides the ability to

convert an AFP input file to fully portable format. The resources are embedded within the data. This is accomplished with the Create AFP Data (CRTAFPDTA) command. In addition, this command can also add indexing to the AFP file. This facilitates easy navigation by the person viewing the data. This same indexing function can be used in conjunction with PDF delivery to segment print files or to provide bookmarking within a PDF file. The Create AFP Data (CRTAFPDTA) command can also convert line (\*LINE) or mixed (\*AFPDSL) data to portable AFP data for printing or viewing. For more information about the Create AFP Data (CRTAFPDTA) command, see Chapter 2, "Using the Create AFP Data (CRTAFPDTA) Command," on page 9.

### **PDF, PostScript, and PCL to AFP Transforms**

Infoprint Server includes an integrated set of transforms to convert ASCII print data – PDF, PostScript, and PCL – to AFP for management and further processing by i5/OS. These transforms are available with optional features 5101 and 5102 of Infoprint Server. Transform Manager automatically detects ASCII print format, invokes the required transform, and places the resulting AFP file on an i5/OS output queue. This enables most ASCII output created on i5/OS or on the network to be put in native i5/OS format (AFP). This lets users take advantage of the i5/OS print or output management capabilities. For more information about the PDF, PCL, and PostScript to AFP transforms, see Chapter 7, "Transforming PCL, PDF, and PostScript Data to AFP," on page 159.

### **Image Transforms**

The final component of Infoprint Server is its image transforms. These transforms, which run on a Windows PC, convert industry standard image formats (GIF, TIFF, and JPEG) into AFP page segments or overlays on your PC. You can use the AFP Manager component of iSeries Navigator or i5/OS commands to create the page segment or overlay on your i5/OS. This lets you use an image in a client or network application and then embed it in an i5/OS application. For more information about the image transforms, see Chapter 3, "Transforming Image Data to AFP," on page 39.

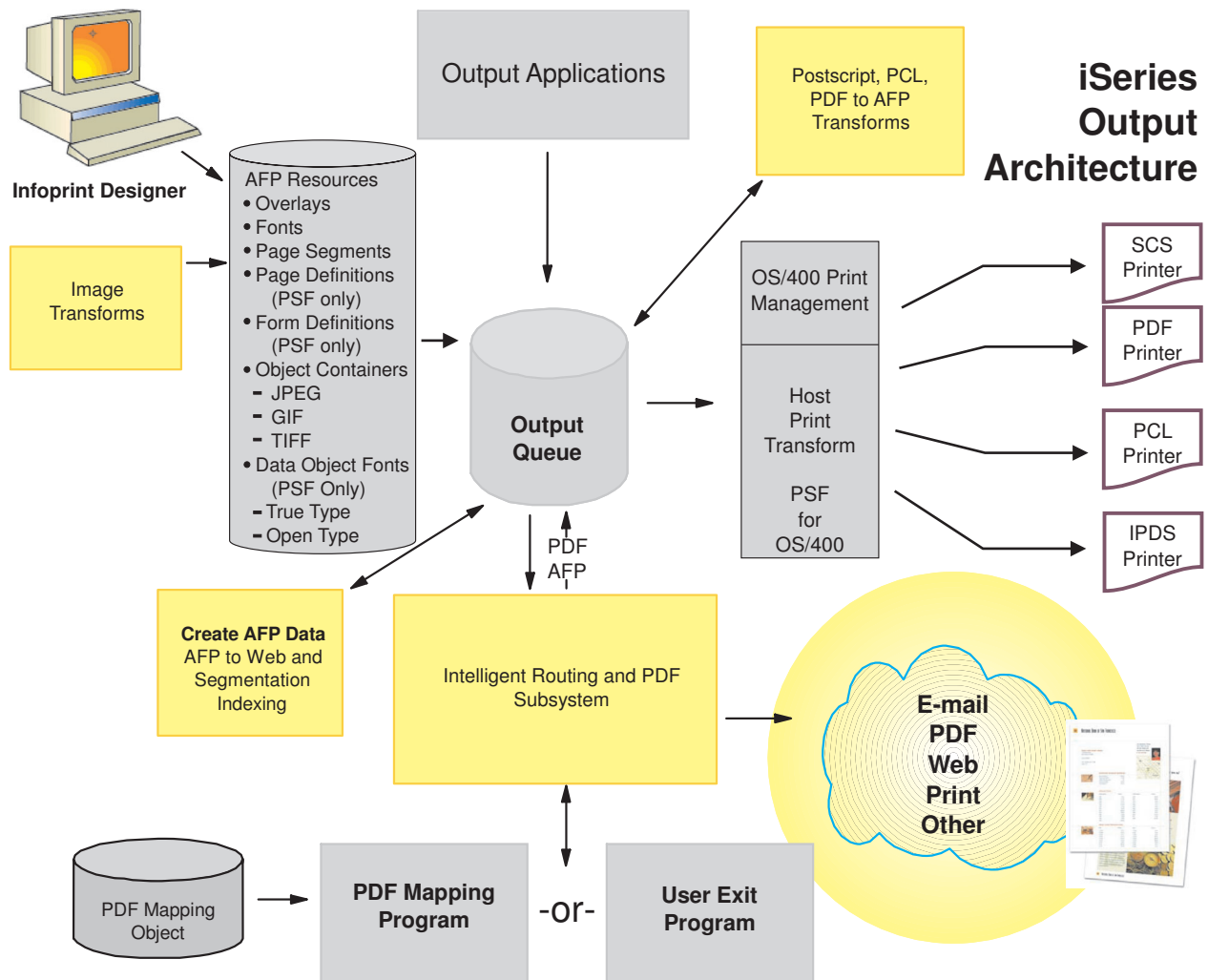

Figure 3. iSeries Output Management with Infoprint Server

Figure 4 on page 6 shows how each Infoprint Server component fits into your i5/OS system. The Infoprint Server components are shaded.

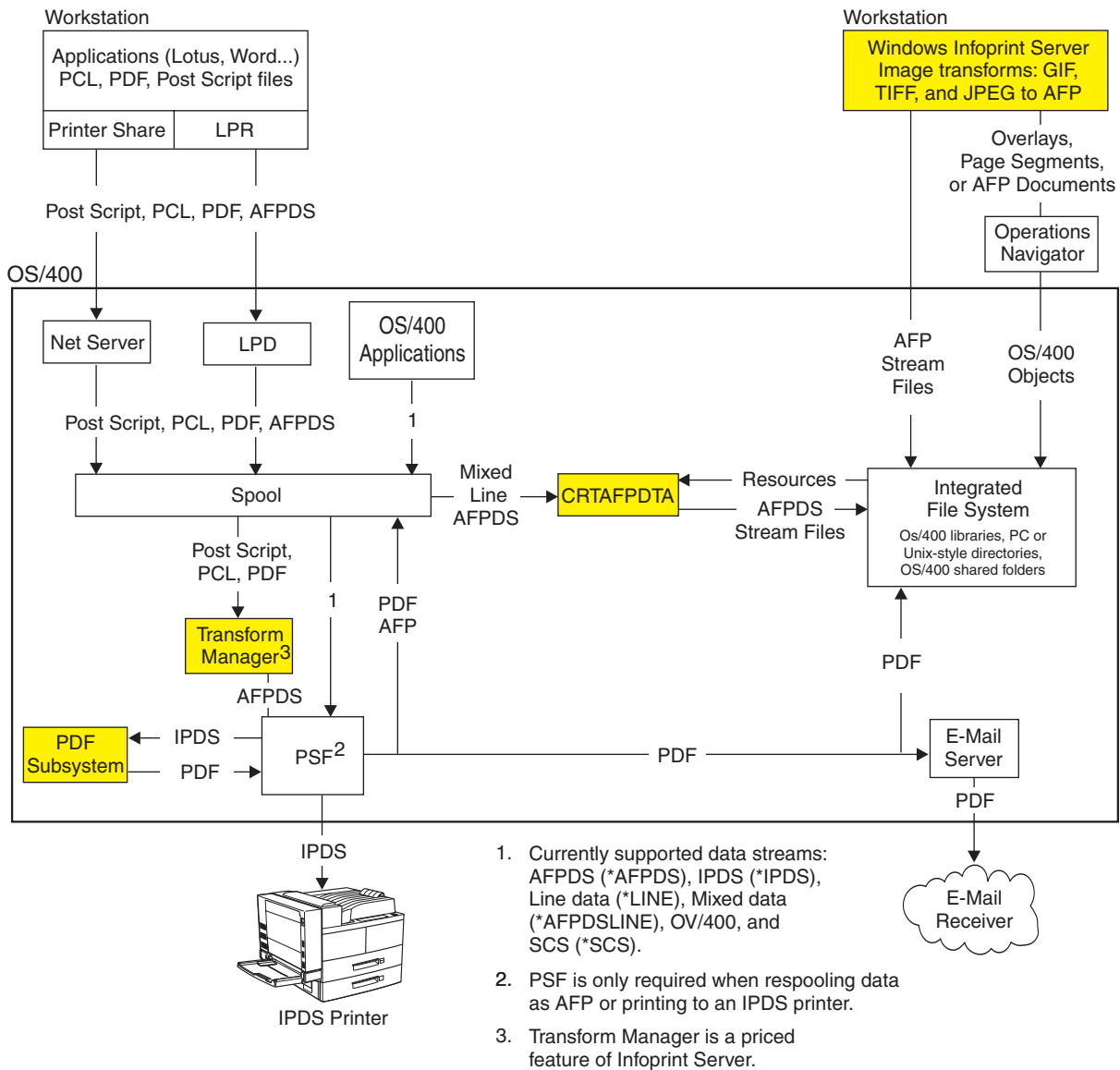

Figure 4. Infoprint Server Components

## What's New in Infoprint Server Version 5.3?

Infoprint Server 5.3 provides these enhancements:

- **Create a map object instead of writing a mapping program:**

This release of Infoprint Server includes a new object called a *map object*. You use menu-driven commands or APIs to specify the PDF customization options to the map object. The options you specify to the map object are used to customize the IBM-supplied mapping program. This lets you control almost every option available in the mapping program without having to program anything.

- **IBM-supplied mapping program**

The IBM-supplied mapping program supplied with this release is for use with a map object. Using these together gives you a simple way to customize Infoprint Server's PDF output.

- **Intelligent routing for PDF files**  
Prior to this version, you could transform a spooled file to PDF then e-mail it, spool it to an output queue, or store it as a stream file in the integrated file system. Now you can do any combination of those with any given PDF file. Additionally, if you use a segmented spooled file, you can route each generated PDF file differently.
- **Respool a spooled file as AFP**  
This function lets you specify that a spooled file that will undergo a transform to IPDS is respooled as AFP. You can respool the whole file, or you can use it with the PDF subsystem to respool one segment of a spooled file, along with the rest of the intelligent routing options.
- **Specify a PDF administrator**  
Changes to the PSF configuration object let you specify an administrator for the PDF subsystem. The PDF administrator is an e-mail address that is notified when there is a problem with the PDF conversion or distribution. When there is an error, such as a missing routing tag for a segment of a spooled file, an e-mail is sent to the PDF administrator with the PDF file attached. This is beneficial because you do not have to reprocess the entire spooled file when just a few segments were not distributed correctly.
- **Enhancements to the PDF subsystem**
  - Output is automatically rotated for portrait or landscape presentation, as appropriate
  - Smaller PDF file size
  - Accepts 2D bar codes PDF417, Maxicode, and Data Matrix, as well as Planet bar code
  - Accepts full color images in FS45 format
  - Accepts GIF, TIFF, JPEG, and single page PDF objects in the input spooled file
- **Enhancements to the mapping program**  
You can specify these new options to the mapping program:
  - Can specify options for all PDF files, not just those being e-mailed
  - PDF output file's name
  - Respool a segment of the input spooled file as AFP or respool the entire input spooled file as AFP
  - Intelligent routing of PDF output
  - Security options for the PDF output when e-mailing, including encryption, public authority level, passwords, and more
  - Accessibility options for the PDF file, when e-mailing
  - Specify the PDF output file's location, when storing in the integrated file system - Infoprint Server will not append a series of directories to the location you specify using a mapping program
  - Specify the output queue for PDF output on a per-file basis, when spooling the PDF file

---

## Installing Infoprint Server

Refer to *Install, upgrade, or delete i5/OS and related software*, SC41-5120-09 for information about installing iSeries programs.



---

## Chapter 2. Using the Create AFP Data (CRTAFPDTA) Command

This chapter describes how to use the Create AFP Data (CRTAFPDTA) command. It contains these sections:

- “Overview of CRTAFPDTA” describes what the command can do and how it works.
- “Syntax” on page 11 gives a syntax diagram of the command.
- “Planning for CRTAFPDTA” on page 13 describes what you need to do and know before using CRTAFPDTA.
- “Indexing with CRTAFPDTA” on page 14 describes how to use CRTAFPDTA to index a spooled file, lists indexing limitations, and describes how to use AFP Viewer to view the output file.
- “Retrieving Resources” on page 16 describes how CRTAFPDTA gathers the resources that are needed to print or view the document.
- “CRTAFPDTA Parameters” on page 17 describes the parameters in detail.
- “CRTAFPDTA Examples” on page 28 gives examples of using the CRTAFPDTA command. It shows how to merge an AFP file with its resources and how to index a file.
- “E-mailing the CRTAFPDTA Output” on page 34 describes how to use the PDF subsystem to e-mail the output from CRTAFPDTA.
- CRTAFPDTA implements functionality available on other platforms with the tool AFP Conversion and Indexing Facility (ACIF). “CRTAFPDTA and ACIF” on page 36 gives two tables that cross reference CRTAFPDTA parameters with ACIF parameters.

---

### Overview of CRTAFPDTA

CRTAFPDTA transforms line (\*LINE), mixed (\*AFPDSLIN), or ASCII XML data, data into AFP (\*AFPDS) data. It can also take an AFP file as input and output an AFP stream file. It indexes a document for viewing, archiving, or document retrieval, and optionally retrieves and packages the AFP resources that are needed for printing or viewing.

**Note:** To get ASCII XML support, install the latest service pack.

CRTAFPDTA takes input data from the spool and creates up to four stream files in the integrated file system:

#### **AFP stream file**

The AFP document. This file is always created. Specify a value for **To stream file** (TOSTMF) to generate this file.

#### **Resource stream file**

A stream file that contains all the resources needed for printing or viewing, as long as Infoprint Server can find the resources and the user is authorized to the resources and the library in which they exist. This file is optional, but is useful for archiving and viewing the document. Specify a value for **To resource stream file** (TORSCSTMF) to generate this file.

### Index stream file

A stream file that contains indexing information. This file is optional, but is useful for viewing the document. Specify a value for **To index stream file** (TOIDXSTMF) to generate this file.

### Merged stream file

A stream file that merges the AFP file with any of the other above files that are created. This file is optional, but is useful for archiving and viewing the document. Specify a value for **To merged stream file** (TOMRGSTMF) to generate this file.

After these files are created, you can use them in an archive system, send them for use on another system, view them with AFP Viewer, use them on the Web, or send them to the PDF Subsystem to be made into one or more PDF files. Figure 5 illustrates this process:

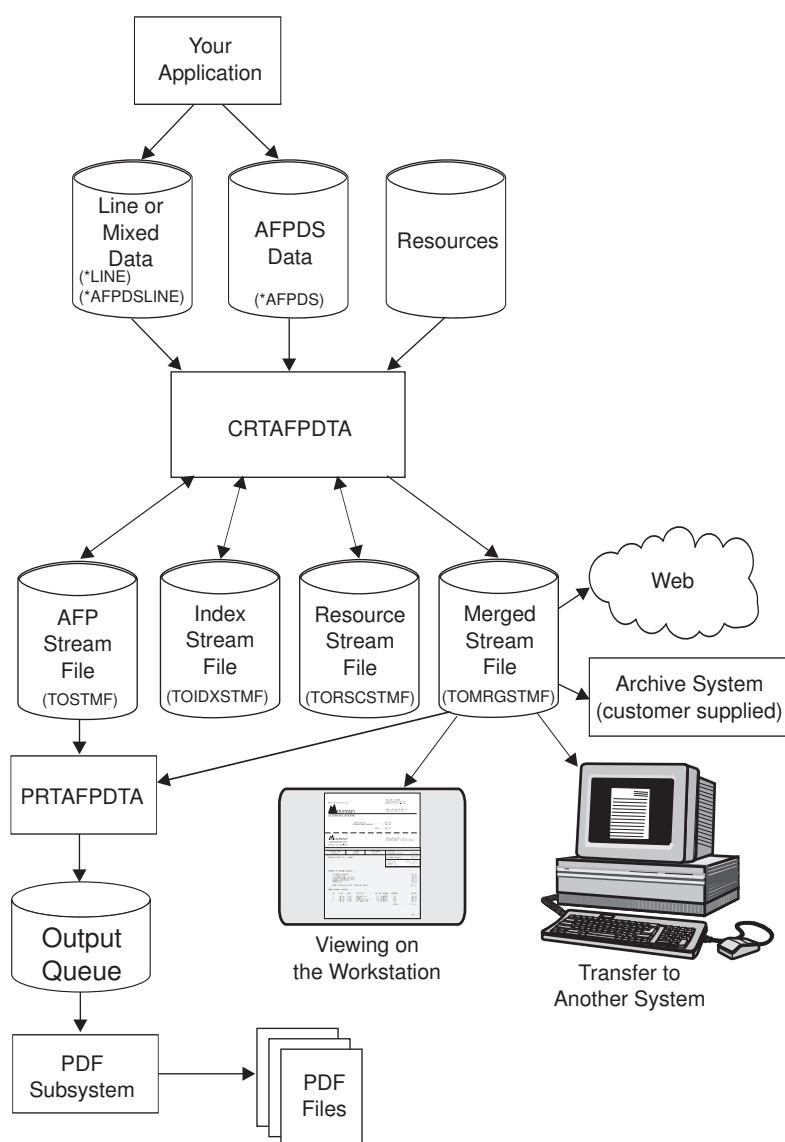

Figure 5. Using CRTAFPDTA

If you archive the resources along with the document, you can print with fidelity forever, even if the resources have changed since the document was converted. For



example, suppose that a page segment contains a company officer's signature and is included in the print data. When someone new replaces the officer, current print files need to reference the new officer's signature. However, archived files must reference the former officer's signature.

The input to this command is a spooled file. The spooled file can be line, mixed, or AFPDS.

**Note:** These values are obtained from the spooled file attributes and cannot be specified on CRTAFPDTA:

- Control character
- Table reference characters
- DBCS SO/SI spacing

The output from this command is one or more stream files in directories.

**Note:** In this chapter whenever the term "file" is used by itself, it means "stream file".

CRTAFPDTA implements functionality available to other platforms with ACIF. ACIF is part of PSF on MVS™, VM, and VSE and is also part of Infoprint Manager on AIX® and Windows NT®. Table 1 on page 36 gives the ACIF equivalencies to CRTAFPDTA parameters. Table 2 on page 37 gives the CRTAFPDTA equivalencies to ACIF parameters. You can find more information about using the functions available through the CRTAFPDTA command in *AFP Conversion and Indexing Facility: User's Guide*, S544-5285.

---

## Syntax

Figure 6 on page 12 shows the command syntax of CRTAFPDTA. For information about the parameters, see "CRTAFPDTA Parameters" on page 17.

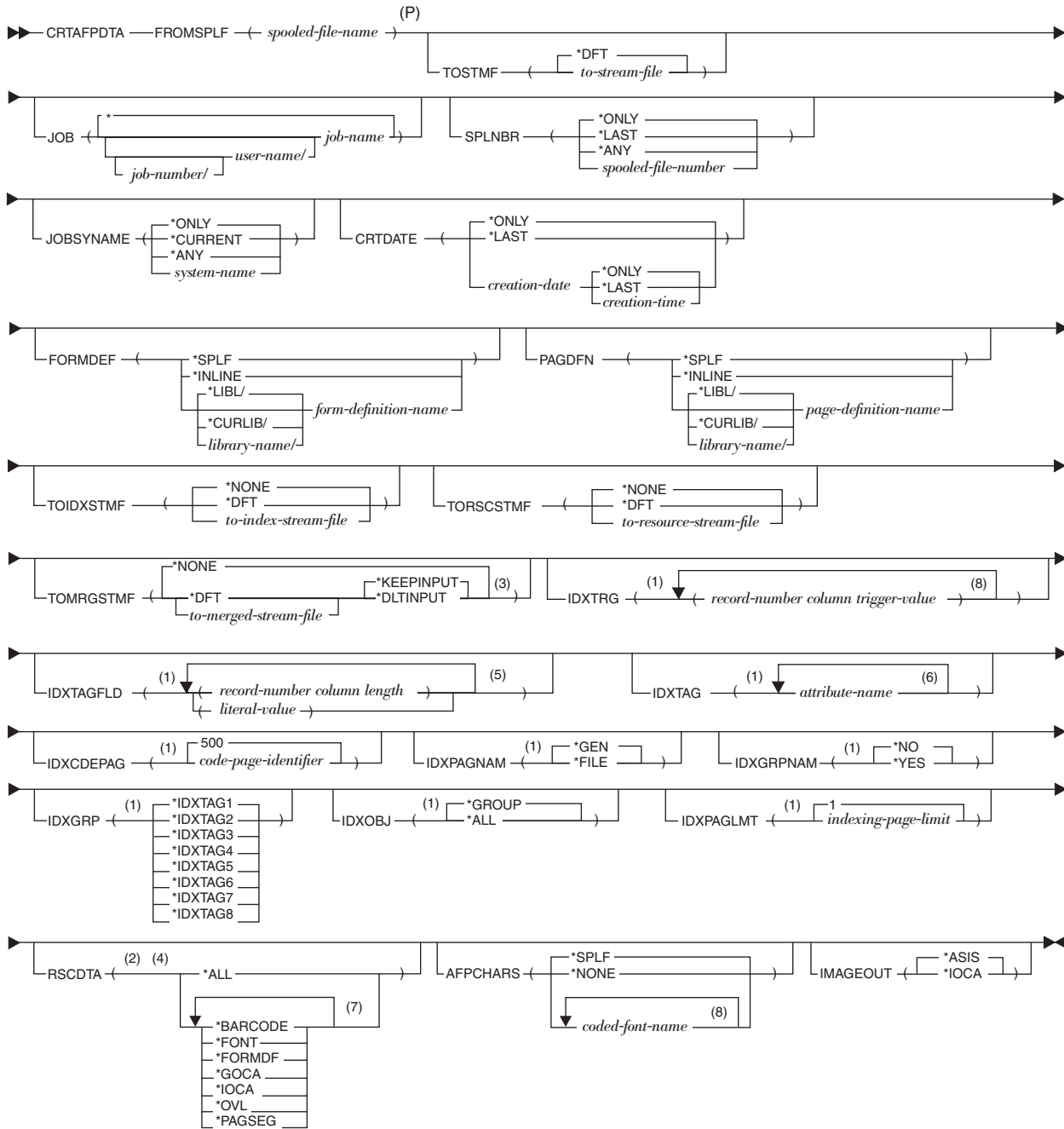

Figure 6. CRTAFPDATA command syntax

**Notes®:**

1. Parameter only valid if TOIDXSTMF value is not \*NONE.
2. Parameter only valid if TORSCSTMF value is not \*NONE.
3. Parameter only valid if either TOIDXSTMF value or TORSCSTMF value is not \*NONE.
4. One or more resource data types must be specified if TORSCSTMF value is not \*NONE.
5. A maximum of 16 repetitions.
6. A maximum of eight repetitions.
7. A maximum of seven repetitions.

- 8. A maximum of four repetitions.
- P. All parameters preceding this point can be specified in positional form.

---

## Planning for CRTAFPDTA

This section describes what you need to do before using CRTAFPDTA and lists the authorities you need in order to use the command.

Before using CRTAFPDTA, you need to decide what you want done with the input file.

- If you want to index a file, you must decide whether you are going to index with data values or with literal values. You also need to decide which values to use. For information about indexing a file, see “Indexing with CRTAFPDTA” on page 14.
- You need to decide whether you want to view the final output. For information about viewing the output see “Viewing the Indexed Output” on page 33.
- You need to decide whether you will want to print the exact same document at a later date. For information about retrieving resources so you can print the same document later, see “Retrieving Resources” on page 16.

## Authorities

To use CRTAFPDTA, you must be authorized to all resources and files needed by the command.

### Spooled File

You must be authorized to the input spooled file by meeting at least one of these conditions:

- You own the input spooled file.
- You have \*READ authority to the spooled file’s queue, the queue is specified as DSPDTA(\*YES), and you have \*EXECUTE authority to the queue’s library.
- You have \*SPLCTL special authority.
- You have \*SPLNBRCTL special authority, the spooled file’s queue is specified as OPRCTL(\*YES), and you have \*EXECUTE authority to the queue’s library.
- You own the spooled file’s queue, the queue is specified as AUTCHK(\*OWNER), and you have \*EXECUTE authority to the queue’s library.
- You have read, add, and delete authority to the spooled file’s queue and the queue is specified as AUTCHK(\*DTAAUT). You also have \*EXECUTE authority to the queue’s library.

### AFP Resources

You must have all of these authorities to all processed AFP resources:

- **Resource Authority:** \*USE
- **Library Authority:** \*EXECUTE
- **Resource Lock:** \*SHRRD

### Input and Output Stream Files

You must have all of these authorities to all the stream files you use:

- **Authority to directories in the path where the stream file resides:** \*X
- **Authority to merged stream file:** \*W
- **Authority to stream files that are input to merged stream file:** \*R
- **Authority to parent directories of new stream files:** \*WX

## Indexing with CRTAFPDTA

Indexing is one of the primary tasks for which CRTAFPDTA is used. CRTAFPDTA indexes a document by inserting tags in the print file and, optionally, in the index object file. Indexing lets you divide a large print file into uniquely identified smaller units, called *groups*. A group is a named collection of sequential pages. For example, you can divide a large bank statement application into groups that are made up of individual statements. Each statement is uniquely identified by its group name, which might be the account number or other attributes such as the date and a Social Security number.

One of the main reasons to use CRTAFPDTA to index a file is for use with the PDF subsystem. Once indexed, the PDF subsystem can take the file, create a PDF file from each group, and e-mail each PDF file to a different person. In the example above, you could send the indexed bank statement output to the PDF subsystem then e-mail each statement to the appropriate customer.

Using CRTAFPDTA, you can also create an index object file, which lets you do this:

- Retrieve individual statements from storage, based on an account number or any other attribute.
- More rapidly access the statements for viewing with, for example, AFP Viewer.
- Archive individual statements or the entire indexed print file for long-term storage and subsequent data management and reprinting, even years after its creation.

Figure 7 shows the relationship between the group-level tags and the entries in the index object file.

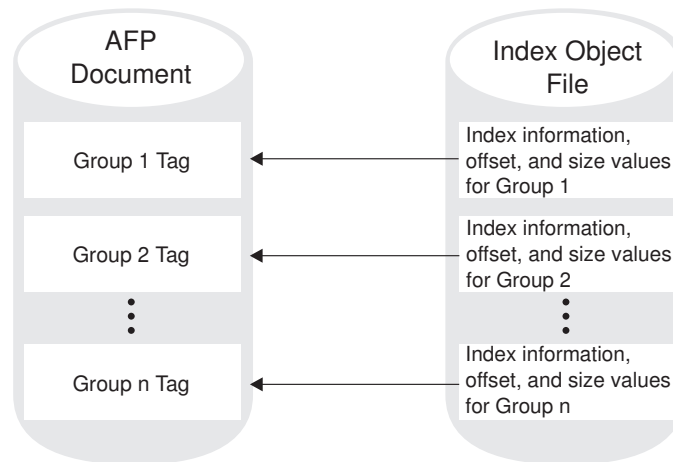

Figure 7. AFP Document with Index Tags and the Index Object File

CRTAFPDTA lets you generate the indexing tags in one of these ways:

- Using values present in the input data. This is useful when the data has been formatted so that CRTAFPDTA can reliably locate the values. This kind of indexing is called *indexing with data values*.
- Using literal values that you specify to CRTAFPDTA. This is useful when the values you want to use in the indexing tags are not consistently present in the data. This kind of indexing is called *indexing with literal values*.

## Indexing with Data Values

When you index with data values, you use data that is in the same place in every group to identify a group of pages. If you index a bank statement, the account number is a type of data value that you might want to use. You can then use the account number to archive a single customer's account statement. This lets you use the account number to retrieve and view the statement. This type of indexing uses the **Index trigger definition (IDXTRG)**, **Index field definition (IDXTAGFLD)**, and **Index tag definition (IDXTAG)** parameters. Use **To merged stream file (TOMRGSTMF)** to generate a merged stream file if you want to view the output file with indexing and resources. See "Indexing with CRTAFPDTA" on page 29 for an example of indexing with data values.

## Indexing with Literal Values

Some print files, such as technical documents and memos, do not have a data value is consistently present in the same location. Therefore, CRTAFPDTA cannot easily use data values to divide the document into groups of pages. Likewise, the output of an application might not contain the data you want to use for an indexing tag. In these cases, you can specify one or more literal values for CRTAFPDTA to use as indexing tags for a single group of pages. This type of indexing uses the **Index field definition (IDXTAGFLD)** parameter. Use **To merged stream file (TOMRGSTMF)** to generate a merged stream file if you want to view the output file with indexing and resources. In "Indexing with CRTAFPDTA" on page 29, the literal value Telephone Bill is used.

### Notes:

1. If try to use CRTAFPDTA to add indexing tags to a file that already contains indexing tags, CRTAFPDTA issues an error message and stops processing. If the input file already contains indexing tags, you can create the index object file by running CRTAFPDTA without specifying any indexing parameters.
2. CRTAFPDTA includes the name of the output document in the index object file and includes the name of the index object file in the output document. This gives a method of correlating the index object file with the appropriate output document.

## Indexing Limitations

If you have a line-mode application that is not suitable for indexing with data values or literal values, the application program cannot insert tagging structured fields in the print data. This is because tagging structured fields are not allowed in line data. To solve this problem, you can place index values in a No Operation (NOP) structured field. Then use those values with appropriate values for **Index trigger definition (IDXTRG)** and **Index field definition (IDXTAGFLD)** to index the file. For information about structured fields, refer to *Data Stream and Object Architectures: Mixed Object Document Content Architecture™ Reference*, SC31–6802.

When application data does not contain appropriate data values for indexing, the application can add the index triggers. One possible location is the record containing the new-page carriage control character (for example, a skip-to-channel 1). To do this, the application needs to add the indexing trigger and attribute value to this record at a specified location on each statement in the print file. This lets CRTAFPDTA retrieve the information at processing time.

---

## Retrieving Resources

CRTAFPDTA can determine the list of AFP resources, such as fonts and page segments, that are needed to view or print the document. It can then retrieve these resources and store them in a stream file. CRTAFPDTA can then merge these resources with the AFP output file. This function is especially valuable if the resources are not present on the designated platform in a distributed print environment. If you merge the resources with the AFP output file, you can archive the document in the current form. This allows you to reproduce the document with fidelity at a later date, even if the resources have changed. Merging an AFP file with its resources also lets you use the AFP file with a Web browser or send it to other systems without worrying about resource availability.

The type of resources CRTAFPDTA retrieves from specified libraries is based on the value of the **Resource Data** (RSCDTA) parameter. When CRTAFPDTA processes a print file, it does this:

- Identifies the resources requested by the print file  
While CRTAFPDTA converts the input file to AFP, it builds a list of all the resources necessary to print the document. This includes all the resources referenced inside other resources. For example, a page can include an overlay and an overlay can reference other resources such as fonts and page segments.
- Creates a resource file  
CRTAFPDTA creates a logical resource library in the form of an AFP resource group and stores this resource group in a resource file. Specifying **RSCDTA(\*BARCODE, \*FONT, \*FORMDF, \*GOCA, \*IOCA, \*OVL, \*PAGSEG)** or **RSCDTA(\*ALL)** guarantees that the resource file contains all the resources necessary to view or print the document with fidelity, as long as Infoprint Server can find the resources and the user is authorized to the resources and the library in which they exist. You can verify that the resources were all found by viewing the merged file with AFP Viewer.
- Includes the name of the output document in the resource file and the name of the resource file in the output document  
This provides a method of correlating resource files with the appropriate output document.

An example of specifying CRTAFPDTA parameters for resource retrieval can be found in “CRTAFPDTA Examples” on page 28.

## How CRTAFPDTA Searches for AFP Resources

CRTAFPDTA looks for resources in several different places. You can library-qualify a resource if you specify it in one of these ways:

- Use the **Form definition** (FORMDF) or **Page definition** (PAGDFN) parameters to specify a form definition or page definition directly to CRTAFPDTA.
- Specify a resource in the input spooled file’s attributes.
- Use DDS keywords, such as OVERLAY or PAGSEG to specify a resource.

The library-qualifier can be \*LIBL, \*CURLIB, or a library name. If a resource is not library-qualified, CRTAFPDTA searches \*LIBL for the resource. If \*LIBL or \*CURLIB is used as the library-qualifier and a resource which you are authorized to use is not found, CRTAFPDTA searches the font libraries QFNTCPL, QFNT01-QFNT19, and QFNT61-QFNT69 for the resource. If the resource is still not found, CRTAFPDTA issues an error message and stops processing.

---

## CRTAFPDTA Parameters

This section describes each parameter used with the CRTAFPDTA command. The parameters are listed alphabetically by keyword.

### AFP characters (AFPCHARS)

Specifies one or more AFP coded fonts to use with line data and a page definition.

**\*SPLF** Use the values for **AFP characters** (AFPCHARS) that are specified in the spooled file attributes for the input spooled file.

**\*NONE**

No AFP characters are specified.

*coded-font-name*

Specifies up to four 4-byte names. The 4-byte names are concatenated to 'X0' to identify up to four coded fonts which are used when table reference characters (spooled file attribute TBLREFCHR) are in the data.

### Spooled file created (CRTDATE)

Specifies the date and time the input spooled file was created.

**\*ONLY** There is only one spooled file with the specified job name, user name, job number, spooled file name, spooled file number, and job system name.

**\*LAST** Use the spooled file created most recently with the specified job name, user name, job number, spooled file name, spooled file number, and job system name.

*spooled-file-create-date*

Specify the date the spooled file was created. If you specify *spooled-file-create-date*, you must also specify a value for the time the spooled file was created.

The possible time values are:

**\*ONLY**

There is only one spooled file with the specified job name, user name, job number, spooled file name, spooled file number, job system name, and spooled file creation date.

**\*LAST**

Use the spooled file created most recently with the specified job name, user name, job number, spooled file name, spooled file number, job system name, and spooled file creation date.

*spooled-file-create-time*

Specify the time the spooled file was created.

### Form definition (FORMDF)

Specifies the form definition to use when processing the spooled file. A form definition is a resource that defines the characteristics of the physical form. Some of these characteristics are overlays to be used, the position of page data on the form, number of copies of pages, and modification to pages.

**\*SPLF** Use the value specified for **Form definition** in the spooled file's

attributes. CRTAFPDTA cannot use \*DEVDT from the spooled file's **Form definition** attribute. If \*DEVDT is specified, either change the spooled file attribute by naming a form definition or by using *form-definition-name* to specify a form definition for CRTAFPDTA.

**\*INLINE**

A form definition is included in the input data.

*form-definition-name*

Specifies the name of the form definition. A form definition name can be up to eight characters long. This form definition overrides any specified in the spooled file's attributes or inline in the data. You must also specify the library that contains the form definition.

The possible library values are:

**\*LIBL** All libraries in the job's library list are searched until the form definition is found. If the form definition is not found, the font libraries QFNTCPL, QFNT01-QFNT19, and QFNT61-QFNT69 are searched.

**\*CURLIB** The form definition is in the current library for the job. If no library is specified as the current library for the job, QGPL is used. If the form definition is not found, the font libraries QFNTCPL, QFNT01-QFNT19, and QFNT61-QFNT69 are searched.

*library-name* Specifies the library where the form definition is located. The form definition must be in the specified library.

**From spooled file (FROMSPLF)**

This parameter is required. It specifies the name of the spooled file that contains the data that CRTAFPDTA processes.

*spooled-file-name*

Specifies the name of the spooled file that CRTAFPDTA processes. CRTAFPDTA can process \*LINE, \*AFPDSLIN, or \*AFPDS data.

**Index code page identifier (IDXCDEPAG)**

Specifies the code page to be used for the index values and attribute names produced by CRTAFPDTA. This value is used by programs that display indexing information. These programs use this value with code page translation tables to represent the information.

This parameter is only valid if **To index stream file (TOIDXSTMF)** has a value other than \*NONE.

**500** Code page identifier 500.

*code-page-identifier*

A code page identifier from 1–65535.

**Select index for group names (IDXGRP)**

Specifies which of the eight possible **Index tag definition (IDXTAG)** values should be used as the group name for each index group. IBM recommends that you use the most unique index value for the group name. The intent is for each group in the output file to have a unique name. For instance, assume you used a customer's name, phone number, area code, and the date to index phone bills, as in "Indexing with CRTAFPDTA" on page 29. The most unique



index value is the customer name or phone number. The value for this parameter uses the **Index field definition** (IDXTAGFLD) definitions from the **Index tag definition** parameter but does not include the attribute name.

The AFP Viewer displays this value along with the attribute name and index value. You can use the group name to select a group of pages to view. For more information about viewing indexed documents, refer to *iSeries Guide to Output*.

This parameter is only valid if **To index stream file** (TOIDXSTMF) has a value other than \*NONE.

**\*IDXTAG1**

Use the first **Index tag definition** value.

**\*IDXTAG2-\*IDXTAG8**

Use the specified **Index tag definition** value.

**Generate group names (IDXGRPNAM)**

Specifies whether CRTAFPDTA creates a unique group name for each group in the output file.

This parameter is only valid if **To index stream file** (TOIDXSTMF) has a value other than \*NONE.

**\*YES** CRTAFPDTA creates a unique group name by generating an 8-character numeric string and appending the string to the group name.

**\*NO** CRTAFPDTA does not generate the string. Specify \*NO if the group name is a routing tag.

**Information for index file (IDXOBJ)**

Specifies how much information CRTAFPDTA writes to the index object file. This determines the level of detail that appears in the index.

This parameter is only valid if **To index stream file** (TOIDXSTMF) has a value other than \*NONE.

**\*GROUP** Only group-level entries are put into the index object file.

**\*ALL** Both page-level and group-level entries are put into the index object file. Only specify this value if you have Tagged Logical Element structured fields (TLEs) in the input data stream. If you use the DOCIDXTAG DDS keyword (which generates TLEs), refer to DDS Reference: Printer Files topic in the iSeries Information Center for more information.

**Indexing page limit (IDXPAGLMT)**

Specifies the output page number by which CRTAFPDTA must find an indexing field if CRTAFPDTA is indexing the file. If CRTAFPDTA does not find an indexing field by the end of the specified page, processing stops.

This parameter is helpful if your file contains header pages. You can specify a page number one greater than the number of header pages, so that CRTAFPDTA will continue to look for matches after the header pages.

This parameter is only valid if **To index stream file** (TOIDXSTMF) has a value other than \*NONE.

**\*1** An indexing field must be found in the first output page.

*indexing-page-limit*

A number from 1–99.

**Generate page names (IDXPAGNAM)**

Specifies whether CRTAFPDTA generates page names using an 8-byte counter or uses structured field tokens that are found in the input data stream. If the input data contains Begin Page structured fields (BPGs) with Fully Qualified Name triplets (FQNs), CRTAFPDTA does not generate page names.

Use of this parameter requires technical knowledge of the makeup of the input file. Such users will understand the explanation of this parameter. All other users should use the default value of \*GEN.

This parameter is only valid if **To index stream file** (TOIDXSTMF) has a value other than \*NONE.

**\*GEN** CRTAFPDTA uses an 8-byte counter to generate page names.

**\*FILE** CRTAFPDTA uses structured field tokens in the input data stream to generate page names.

**Index tag definition (IDXTAG)**

Specifies the content of the indexing tags for the entire file. If literal values are specified for every index tag definition, CRTAFPDTA treats the entire file as one page group and uses this information to index the document. CRTAFPDTA stops processing the input file if literal values are specified for all **Index tag definition** parameters and any **Index trigger definition** (IDXTRG) parameters are also specified.

A maximum of eight attribute names can be defined, and each attribute name can be made up of more **Index field definition** (IDXTAGFLD) definitions.

This parameter is only valid if **To index stream file** (TOIDXSTMF) has a value other than \*NONE.

*attribute-name*

Specifies any combination of these:

*literal-value*

Specifies a user-defined attribute name to be associated with the actual index value. For example, assume that the first index tag definition is a customer's bank account number. The value of **Index tag definition** is the account number (for example, 1234567), so the string 'account number' would be a meaningful attribute name.

The attribute name is an EBCDIC character string 1–250 bytes long. Think of it as a label for the actual index value. CRTAFPDTA does not perform any validity checking on the contents of the attribute name.

*field...* Specifies up to 16 **Index field definition** (IDXTAGFLD) definitions that compose the index value such as \*IDXTAGFLD1 (specifies the first value for **Index field definition**). If more than one **Index trigger definition** (IDXTRG) definition is specified, CRTAFPDTA concatenates them into one physical string of data. No delimiters are used between the concatenated fields.

An **Index tag definition** (IDXTAG) value has a maximum length of 250 bytes. Therefore, the total length of all specified

index trigger definitions for a single index cannot exceed this length. CRTAFPDTA reports an error condition and stops processing if **Index tag definition** is too long.

For **Index trigger definition** values that specify data values within the file, CRTAFPDTA determines the actual location of the indexing information based on the indexing anchor record. The indexing anchor record is defined by the **Index trigger definition** values.

**Note:** If one or more **Index trigger definition** parameters are specified (that is, CRTAFPDTA indexes the file), at least one **Index tag definition** parameter must be specified. Also, that index tag must contain at least one *field* parameter value that is not a literal. CRTAFPDTA reports an error condition and stops processing if this rule is not satisfied.

For identification, CRTAFPDTA numbers each index tag based on the order in which they are specified. For example, if a message indicates an error with respect to Index tag definition number 2, a reference is being made to the second index tag you specified. Specify index tag values by number (for example, \*IDXTAG1) for the **Select index for group names** (IDXGRP) parameter.

#### **Index field definition (IDXTAGFLD)**

Specifies the data fields, such as the account numbers, used to construct the indexing information. These data fields can be specified as literal values or CRTAFPDTA can retrieve the data from the input records of the file. You can define at most 16 fields.

This parameter is only valid if **To index stream file** (TOIDXSTMF) has a value other than \*NONE.

##### ***record-number or literal-value***

Specifies the record number relative to the indexing anchor record, or a literal value.

##### ***record-number***

Specifies the record number relative to the indexing anchor record, which is the first index trigger definition. If you specify *record-number*, you must also specify the *column* and *length*. To specify a record number, enter the number without quotation marks ( ' ).

##### ***literal-value***

Specifies a literal (constant) value. To specify a literal value, enclose the value in quotation marks ( ' ). If you specify a literal value, any values provided for column and length are ignored.

*column* Specifies the byte offset from the beginning of the record to the data field, where 1 is the first byte in the record. For files that contain carriage control characters, column 1 refers to the carriage control character.

For applications that use specific carriage control characters to define page boundaries, for example, skip to channel 1, consider defining the value of the carriage control character as one of the **Index trigger definition** (IDXTRG) parameters.

If the specified value exceeds the physical length of the record, CRTAFPDTA reports an error condition and stops processing.

Specify a column number only when a record number has been specified.

*length* Specifies the number of contiguous bytes (characters), starting at the value specified for *column*, that make up this field. The field can extend outside the record length as long as the column where it begins is in the record length. In this case, CRTAFPDTA adds padding blanks (X'40') to fill out the record. If the field begins outside the length of the record, CRTAFPDTA reports an error condition and stops processing.

Specify a length only when a record number has been specified.

Each field is numbered automatically by CRTAFPDTA based on the order in which you specify the values. The first field you define is numbered one. For example, if a message indicates an error with respect to Index field definition number 9 (\*IDXTAGFLD9), it is referencing the ninth Index field definition you specified.

The **Index tag definition** (IDXTAG) parameter allows you to use index field definitions as part of an index tag definition. For example, to refer to the third index field definition and label that field NAME when specifying an index tag definition, specify IDXTAG(('NAME' (\*IDXTAGFLD3))).

#### **Index trigger definition (IDXTRG)**

Specifies the locations and values of data strings in the input file that are used to define indexing groups. Each **Index trigger definition** specification is made up of three values, the *record-number*, *column-number*, and *value*. When CRTAFPDTA finds *value* in column number *column-number* of record *record-number*, it starts a new page group.

These data strings are referred to as triggers because their presence in the file triggers a processing action. The first **Index trigger definition** specification is special. Each record in the file containing the value specified in the first **Index trigger definition** specification is referred to as an *indexing anchor record*. The indexing anchor record is the reference point from which all indexing information is found.

The number of **Index trigger definition** specifications required to uniquely identify the beginning of a group of pages depends on the complexity of the application output. You can specify at most four triggers.

This parameter is only valid if **To index stream file** (TOIDXSTMF) has a value other than \*NONE.

***record-number or \****

Specifies the relative record number from the indexing anchor record.

***record-number***

A number between 0-255.

**\*** CRTAFPDTA checks every record for the first **Index trigger definition** specification. For example, if you specify IDXTRG(\*,2,'1'), CRTAFPDTA looks in every record until it finds the number 1 in column two. You must specify an asterisk ( \*) in the first **Index trigger definition** specification. You cannot specify an asterisk in any other **Index trigger definition** specification.

***column-number* or \***

Specifies the byte offset from the beginning of the record to the trigger value. The possible values for *column-number* are:

***column-number***

A value from 1 to 32756, where 1 is the first byte in the record. For files that contain carriage control characters, column 1 refers to the carriage control character. CRTAFPDTA compares *trigger-value* to the input data. If the specified trigger value exceeds the physical length of the record, CRTAFPDTA considers the comparison false and continues processing.

\* CRTAFPDTA scans the record from left to right, looking for the *trigger-value*.

***trigger-value***

Specifies the actual alphanumeric or hexadecimal value of the trigger. Surround the value with quotation marks ( ' ). This value is case sensitive and cannot be more than 250 bytes long.

CRTAFPDTA does not perform any validity checking on this value, but uses it to perform a byte-for-byte comparison with the records in the file. If the combined values of *column-number* and the *trigger-value* length exceed the physical length of the record, CRTAFPDTA considers the comparison false and continues processing.

CRTAFPDTA numbers each trigger based on the order in which they are specified. For example, if a message indicates an error with respect to Index trigger definition number 4 (IDXTRG4), a reference is being made to the fourth Index trigger definition you specified.

**Image output (IMAGEOUT)**

Specifies the format of the image data produced by CRTAFPDTA in the output document.

**\*ASIS** The format of the image data is not changed.

**\*IOCA** All image data is output in uncompressed image object content architecture (IOCA) format.

**Job name (JOB)**

Specifies the name of the job that created the input spooled file.

**\_** The job that issued this command created the spooled file.

***job-name*** The name of the job that created the spooled file.

***user-name*** The user name that identifies the user profile under which the job was run.

***job-number*** The system assigned job number.

**System name (JOBSYSNAME)**

Specifies the name of the system where the job that created the input spooled file (specified on the **Job name (JOB)** parameter) was run.

**\*ONLY** There is only one spooled file with the specified job name, user name, job number, spooled file name, spooled file number, and spooled file creation date and time.

**\*CURRENT** Use the spooled file created on the current system with the

specified job name, user name, job number, spooled file name, spooled file number, and spooled file creation date and time.

**\*ANY** Do not consider the job system name when selecting a spooled file. Use this value when you want the **Spooled file create date** and **Spooled file create time** values to take precedence over the job system name when selecting a spooled file.

*job-system-name*

Specify the name of the system where the job that created the spooled file ran.

### Page definition (PAGDFN)

Specifies the page definition used to format line data. This parameter is only used if the input data stream is line (\*LINE) or mixed mode (\*AFPDSLIN). You can use a page definition shipped with i5/OS, create one with a utility such as PPF, or use one created by a service. For the list of page definitions shipped with i5/OS refer to the iSeries Information Center. For information about creating page definitions, see *Page Printer Formatting Aid: User's Guide*.

**\*SPLF** Use the value specified for **Page definition** in the spooled file's attributes. CRTAFPDTA cannot use \*DEV from the spooled file's **Page definition** attribute. If \*DEV is specified, either change the spooled file attribute by naming a page definition or by using *page-definition-name* to specify a page definition for CRTAFPDTA.

**\*INLINE**

A page definition is included in the input data.

*page-definition-name*

Specifies the name of the page definition. A page definition name can be up to eight characters long. You must also specify the library that contains the page definition. This page definition overrides any specified in the spooled file's attributes or inline in the data.

**The possible library values are:**

**\*LIBL** All libraries in the job's library list are searched until the page definition is found. If the page definition is not found, the font libraries QFNTCPL, QFNT01-QFNT19, and QFNT61-QFNT69 are searched.

**\*CURLIB**

The page definition is in the current library for the job. If no library is specified as the current library for the job, QGPL is used. If the page definition is not found, the font libraries QFNTCPL, QFNT01-QFNT19, and QFNT61-QFNT69 are searched.

*library-name*

Specifies the library where the page definition is located. The page definition must be in the specified library.

### Resource Data (RSCDTA)

Specifies the types of resource data that CRTAFPDTA writes to the resource stream file. Your library list (\*LIBL) is searched for the needed resources. Specify **\*ALL** or up to seven types of resources.

This parameter is only valid if **To resource stream file** (TORSCSTMF) has a value other than \*NONE. One or more resource data types must be specified if **To resource stream file** has a value other than \*NONE.

**\*ALL** All resources required to print or view the output document

(specified on the **To stream file** parameter) are included in the resource stream file. When **\*ALL** is specified, you cannot specify other resource types.

- \*BARCODE** Specifies that all bar code object content architecture (BCOCA™) objects included by an Include Object (IOB) structured field required to print or view the output document are included in the resource stream file.
- \*FONT** Specifies that all font character sets, code pages, and coded fonts required to print or view the output file are included in the resource stream file.  
  
If you only want to view the file, do not specify that fonts are to be included in the resource stream file. The AFP Viewer does not use these fonts; it substitutes fonts that are on the PC running AFP Viewer. If you do not include fonts in the resource stream file, you can minimize the size of the stream file.
- \*FORMDF** Specifies that the form definition used in processing the file is included in the resource stream file.
- \*GOCA** Specifies that all graphic object content architecture (GOCA) objects included by an IOB structured field required to print or view the output document file are included in the resource stream file.
- \*IOCA** Specifies that all IOCA objects included by an IOB structured field required to print or view the output document file are included in the resource stream file.
- \*OVL** Specifies that all overlays required to print or view the output document file are included in the resource stream file.
- \*PAGSEG** Specifies that all page segments required to print or view the output document file are included in the resource stream file.

#### **Spooled file number (SPLNBR)**

Specifies the number of the input spooled file from the job specified for **Job name** (JOB).

##### **\*ONLY**

Only one spooled file from the job has the name specified in **From spooled file** (FROMSPLF). If you specify **\*ONLY** and more than one spooled file has the specified name, CRTAFPDTA issues an error message.

##### **\*LAST**

Use the highest numbered spooled file with the specified name.

**\*ANY** Do not consider the file number when selecting a spooled file.

##### *spooled-file-number*

Specifies the number of the spooled file indicated in **From spooled file**.

#### **To index stream file (TOIDXSTMF)**

Specifies the stream file to which the index object file is written.

##### **\*NONE**

The index object information is not written to a stream file.

**\*DFT** The index object file is written to a file with a default name in the

current working directory. If the current working directory references the QSYS.LIB file system, the file name is **outputidx.mbr**. Otherwise, the file name is **output.idx**.

*to-index-stream-file*

Specifies the path of the stream file to which the index object data is written. If the path name is qualified, it must be enclosed in quotation marks. The path name cannot contain a pattern. All directories in the path must exist. New directories are not created. If the stream file does not exist, it is created.

If you specify the file name without a path, the output file is placed in your current working directory. If the file exists, it is overwritten. If you name a directory or path but not a file name, a file with a default name is written. If the specified directory references the QSYS.LIB file system, the file name is **outputidx.mbr**. Otherwise, the file name is **output.idx**.

**To merged stream file (TOMRGSTMF)**

Specifies the stream file into which these stream files are copied:

- AFP stream file, specified with **To stream file (TOSTMF)**
- Index stream file, if it exists. The index stream file is specified with **To index stream file**.
- Resource stream file, if it exists. The resource stream file is specified with **To resource stream file (TORSCSTMF)**.

The original stream files remain on your system unless \*DLTINPUT is specified. Specify a value other than \*NONE for **To merged stream file** if the document references resources that do not exist on all systems and you want to view the output, save the exact document for archival purposes, or send the document to another system. For information about viewing the merged file, refer to *iSeries Guide to Output*.

**\*NONE**

The stream files are not merged.

If you want a merged stream file, use one of these parameters to specify its name:

- \*DFT** The stream files are written to a file with a default name in the current working directory. If the current working directory references the QSYS.LIB file system, the file name is **outputmrg.mbr**. Otherwise, the file name is **output.mrg**.

*to-merged-stream-file-path*

Specifies the path of the stream file to which the stream files are written. If the path name is qualified, it must be enclosed in quotation marks. The path name cannot contain a pattern. All directories in the path must exist. New directories are not created. If the stream file does not exist, the output file is placed in your current working directory.

If you specify the file name without a path, the output file is placed in your current working directory. If the file exists, it is overwritten. If you name a directory or path but not a file name, a file with a default name is written. If the specified directory references the QSYS.LIB file system, the default file name is **outputmrg.mbr**. Otherwise, the default file name is **output.mrg**.



If the merged file is created, specify whether to save the stream files that were copied into the merge file:

**\*KEEPINPUT**

Input stream files are not deleted.

**\*DLTINPUT**

The stream files used as input to the merged stream file are deleted after the merged stream file is written.

**To resource stream file (TORSCSTMF)**

Specifies the stream file to which resources are written. One or more resource data types must be specified in **Resource Data (RSCDTA)** if **To resource stream file** has a value other than \*NONE.

**\*NONE**

Resources are not written to a stream file.

**\*DFT** The resource information is written to a file with a default name in the current working directory. If the current working directory references the QSYS.LIB file system, the file name is **outputrsc.mbr**. Otherwise, the file name is **output.rsc**.

*to-resource-stream-file*

Specifies the path of the stream file to which the resource data is written. If the path name is qualified, it must be enclosed in quotation marks. The path name cannot contain a pattern. All directories in the path must exist. New directories are not created. If the stream file does not exist, it is created.

If you specify the file name without a path, the output file is placed in your current working directory. If the file exists, it is overwritten. If you name a directory or path but not a file name, a file with a default name is written. If the specified directory references the QSYS.LIB file system, the file name is **outputrsc.mbr**. Otherwise, the file name is **output.rsc**.

**To stream file (TOSTMF)**

Specifies the stream file to which CRTAFPDTA writes the transformed data.

**\*DFT** The transformed data is written to a file with a default name in the current working directory. If the current working directory references the QSYS.LIB file system, the file name is **outputafp.mbr**. Otherwise, the file name is **output.afp**.

*to-stream-file-path*

Specifies the path name of the stream file to which transformed data is written. If the path name is qualified, it must be enclosed in quotation marks. It cannot contain a pattern. All directories in the path name must exist. New directories are not created. If the stream file does not exist, it is created.

If you specify the file name without a path, the output file is placed in your current working directory. If the file exists, it is overwritten. If you name a directory or path but not a file name, a file with a default name is written. If the specified path references the QSYS.LIB file system, the file name is **outputafp.mbr**. Otherwise, the file name is **output.afp**.

---

## CRTAFPDTA Examples

This section shows the CRTAFPDTA command used these ways:

1. "Merging Resources with Data" shows CRTAFPDTA being used to package resources with the data for viewing, archiving, or use on another system.
2. "Indexing with CRTAFPDTA" on page 29 shows a file being indexed with data and literal values, then merged for viewing, archiving, or use on another system.

See "Example" on page 35 for an example of a file being indexed and sent to the PDF subsystem for e-mailing.

### Merging Resources with Data

In this example, the AFP file MERGE\_ME is going to be archived. To ensure that we can print the document later exactly as it appears now, it is merged with the resources required to print or view it. All of the resources are copied into the merged file, as long as Infoprint Server can find the resources and the user has authority to the resources and the libraries they are in. After running the command, you can use AFP Viewer to verify that the resources are all there.

```
CRTAFPDTA
FROMSPLF(MERGE_ME)
TOSTMF(*DFT)
FORMDF(*SPLF)
PAGDFN(*SPLF)
TORSCSTMF(*DFT)
RSCDTA(*ALL)
TOMRGSTMF('/MYOUTPUT/MERGED.MRG' *DLTINPUT)
```

*Figure 8. Example CRTAFPDTA Command*

Figure 8 specifies this information:

**FROMSPLF(MERGE\_ME)**

MERGE\_ME is the input spooled file name.

**TOSTMF(\*DFT)**

Store the output AFP file in the default location with the default name.

**FORMDF(\*SPLF)**

Use the form definition specified in the spooled file attributes to process the input file.

**PAGDFN(\*SPLF)**

Use the page definition specified in the spooled file attributes to process the input file.

**TORSCSTMF(\*DFT)**

Store all of the resources needed to view and print the file in a stream file with the default name in the default location. The types of resources to store in this file are specified in **Resource Data** (RSCDTA).

**RSCDTA(\*ALL)**

Copy all resources (the form definition, page segments, overlays, fonts, bar codes, IOCA objects, and GOCA objects) that are needed to process this file into the resource stream file.

**TOMRGSTMF('/MYOUTPUT/MERGED.MRG' \*DLTINPUT)**

Merge the AFP file (TOSTMF) and the resource file (TOMRGSTMF)

together. Name the new file MERGED.MRG and store it in the directory MYOUTPUT, then delete the AFP file and the resource file.

Default values are used for the parameters that are not listed above.

## Indexing with CRTAFPDTA

In this example, an application generates telephone bills, as is shown in Figure 9 on page 30. It then spools the data without specifying a page definition or form definition. The objective is to make the billing application output available on customer service representatives' workstations. Then, when a customer calls with a billing inquiry the representative can view the bill in the same format as a the customer's printed copy.

To achieve this objective, you must convert the output from the application into a document format that can be used with AFP Viewer. You also need to index the file to facilitate searching the file with AFP Viewer. To ensure that all resources used in the bills are available at the workstation, you need to retrieve all resources.

These are the tasks:

- Examine the input file to determine how to tag it for indexing.
- Verify that your document correctly identifies the libraries in which referenced AFP resources reside. If \*LIBL is specified, confirm that the job running CRTAFPDTA has access to the necessary libraries. Also verify that the job running CRTAFPDTA has the required authority to use the referenced AFP resources.
- Use CRTAFPDTA parameters to specify the page definition and form definition, index the document, retrieve resources, and create a merged file.
- Use AFP Viewer to display the merged stream file.

For further description of any parameter used in this section, see "CRTAFPDTA Parameters" on page 17.



**BIG BEND**  
**TELEPHONE COMPANY**  
Serving Texans since 1903

Amount Due
\$ 242.11

---

Billy Bob Smith (214) 555-1234  
RFD 23  
Big Bend, Texas 65902

**BIG BEND TELEPHONE COMPANY**  
**PO BOX 985**  
**BIG BEND, TX 65932-0985**

---

*Service  
Summary*

June 1990

Long Distance Charges (North Star)	\$ 142.85
Local Telephone Charges	\$ 44.00
Equipment Charges	\$ 34.50
Federal, State and Local Taxes	\$ 28.76
Please Pay this Amount ==>	
	\$ 242.11

IF YOU HAVE QUESTIONS, PLEASE CALL 852-3381  
PLEASE MAKE CHECKS PAYABLE TO BIG BEND TELEPHONE COMPANY



**INTERSTATE TELEPHONE**  
LEADING THE WAY IN LONG DISTANCE CONNECTIONS

Billy Bob Smith  
RFD 23  
Big Bend, Texas 65902

Date	Time	City	Area Code and Number	Total Minutes	Charges
06/01/90	11:17 AM	Dallas, TX	(214) 555-6330	7.0	\$ 1.20
06/01/90	4:00 PM	Portland, OR	(503) 555-7435	65.1	\$ 11.30
06/01/90	6:39 AM	Greenville, MS	(601) 555-9534	25.6	\$ 7.85
06/03/90	11:30 AM	Podunk, UT	(801) 555-2630	13.5	\$ 7.65
06/05/90	8:50 PM	Cucamonga, CA	(213) 555-0534	14.6	\$ 9.25
06/06/90	10:20 PM	Buffalo, NY	(716) 555-7434	34.2	\$ 16.15
06/09/90	8:10 AM	Cripple Creek, CO	(303) 555-0332	11.0	\$ 4.20
06/09/90	9:01 AM	Natchez, MS	(601) 555-2134	2.7	\$ .75
06/09/90	12:14 PM	Podunk, UT	(801) 555-1737	5.5	\$ 2.90
06/11/90	4:34 PM	Long Beach, CA	(213) 555-7284	9.3	\$ 4.25
06/14/90	7:46 AM	Tombstone, AZ	(602) 555-1237	1.8	\$ 1.35
06/16/90	9:25 AM	Ouray, CO	(303) 555-8113	4.3	\$ 2.35

Figure 9. Example of a Customer's Phone Bill

### Input File

In this example, an application generates a spooled file containing statement data named PHONE. The application uses a printer file that specifies DEVTYPE(\*LINE). CRTAFPDTA is used to process the spooled file. Figure 10 on page 31 shows the data read by CRTAFPDTA.

```

Carriage
Control
|
Line *...+....1....+....2....+....3....+....4....+....5....+....6....+....7....+....8....+....9
0 1
2Billy Bob Smith RFD 23 Big Bend, Texas 65902 (214) 555-1234
!□□□L°Q□□□01PHTOTL□□j□□□
June 1990
Long Distance Charges (North Star) $ 142.85
5 Local Telephone Charges $ 44.00
Equipment Charges $ 34.50
Federal, State and Local Taxes $ 28.76

10 Please Pay this Amount ====> $ 242.11
1
3Billy Bob Smith RFD 23 Big Bend, Texas 65902 (214) 555-1234
!□□□L°Q□□□01PHISTC□□j□□□
!□□□L°Q□□□01PHLDIS□□j□□□
15 06/01/90 11:17 AM Dallas,TX (214) 555-6330 7.0 $ 1.20
06/01/90 4:00 PM Portland,OR (503) 555-7435 65.1 $ 11.30
06/01/90 6:39 AM Greenville,MS (601) 555-9534 25.6 $ 7.85
06/03/90 11:30 AM Podunk,UT (801) 555-2630 13.5 $ 7.65
06/05/90 8:50 PM Cucamonga,CA (213) 555-0534 14.6 $ 9.25
20 06/06/90 10:20 PM Buffalo,NY (716) 555-7434 34.2 $ 16.15
06/09/90 8:10 AM Cripple Creek,CO (303) 555-0332 11.0 $ 4.20
06/09/90 9:01 AM Natchez,MS (601) 555-2134 2.7 $ .75
06/09/90 12:14 PM Podunk,UT (801) 555-1737 5.5 $ 2.90
06/11/90 4:34 PM Long Beach,CA (213) 555-7284 9.3 $ 4.25
25 06/14/90 7:46 AM Tombstone,AZ (602) 555-1237 1.8 $ 1.35
06/16/90 9:25 AM Ouray,CO (303) 555-8113 4.3 $ 2.35
1
3Billy Bob Smith RFD 23 Big Bend, Texas 65902 (214) 555-1234
!□□□L°Q□□□01PHISTC□□j□□□
!□□□L°Q□□□01PHLDIS□□j□□□
30 06/17/90 11:17 AM Mesquite,TX (214) 555-9707 4.0 $ 1.05
06/17/90 7:00 PM Crater Lake,OR (503) 555-9079 65.1 $ 11.30
06/19/90 8:39 AM Natchez,MS (601) 555-5204 34.4 $ 11.85
06/20/90 11:30 AM Podunk,UT (801) 555-4238 13.5 $ 7.65
35 06/21/90 8:50 PM Beverly Hills,CA (213) 555-8290 14.6 $ 9.25
06/22/90 8:10 AM Denver,CO (303) 555-1264 11.0 $ 4.20
06/22/90 10:20 PM Buffalo,NY (716) 555-8203 34.2 $ 16.15
06/23/90 8:01 AM Natchez,MS (601) 555-9234 2.7 $ .75
06/23/90 4:34 PM Cucamonga,CA (213) 555-3426 9.3 $ 4.25
40 06/23/90 12:14 PM Salt Flats,UT (801) 555-7228 5.5 $ 2.90
06/24/90 7:46 AM Tucson,AZ (602) 555-8233 1.8 $ 1.35
06/24/90 9:25 AM Punkin Center,CO (303) 555-5241 4.3 $ 2.95

```

Figure 10. Example Telephone Bill Input File

**Note:** There are some entries in the figure, such as  
 □□□L°Q□□□01PHTOTL□□j□□□, that have unprintable characters.  
 These are AFPDS records that reference overlays and cannot be displayed.

In Figure 10, the spooled file contains telephone statements that are dated May and June 1990. Each customer's statement has the same general format, although statements vary in size and. Assume you want the customer service representatives to be able to find a customer statement based on the customer's name, area code, phone number, or date. These values will be our index tags.

Because the statements are different lengths, CRTAFPDTA needs to be able to determine when a new statement begins. Each new statement has the customer's

name on every page. The first page of every statement has the phrase "Local Telephone Charges". We will use the name and Local Telephone Charges as triggers.

## **CRTAFPDTA Command**

This is the command you use to index the statements:

```
CRTAFPDTA
FROMSPLF(PHONE)
TOSTMF('/MYOUTPUT/PHONE.AFP')
SPLNBR(*LAST)
FORMDF(*LIBL/F1BILL)
PAGDFN(*LIBL/P1BILL)
TOIDXSTMF('/MYOUTPUT/PHONE.IDX')
TORSCSTMF('/MYOUTPUT/PHONE.RSC')
IDXTRG((* 1 '1') (5 3 'Local Telephone Charges'))
IDXTAGFLD((1 2 20) (1 76 3) (1 81 8) (3 3 12) ('Telephone Bill'))
IDXTAG(('NAME' (*IDXTAGFLD1)) ('AREA' (*IDXTAGFLD2))
('PHONE' (*IDXTAGFLD3)) ('DATE' (*IDXTAGFLD4)))
IDXCDEPAG(500)
RSCDTA(*FORMDF *PAGSEG *OVL)
TOMRGSTMF('/MYOUTPUT/PHONE.MRG' *DLTINPUT)
```

*Figure 11. Example CRTAFPDTA Command*

Figure 11 specifies this information:

### **FROMSPLF(PHONE)**

PHONE is the input spooled file name.

### **TOSTMF('/MYOUTPUT/PHONE.AFP')**

Store the transformed data in the directory MYOUTPUT and name it PHONE.AFP.

### **SPLNBR(\*LAST)**

There are multiple spooled files named PHONE that this job created. Use the spooled file named PHONE with the highest number.

### **FORMDF(\*LIBL/F1BILL)**

Check the library list for a form definition named F1BILL. Use that form definition to specify information about the physical form.

### **PAGDFN(\*LIBL/P1BILL)**

Check the library list for a page definition named P1BILL. Use that page definition to arrange the data.

### **TOIDXSTMF('/MYOUTPUT/PHONE.IDX')**

Create a file that contains the indexing information. Call the file PHONE.IDX and store it in the directory MYOUTPUT.

### **TORSCSTMF('/MYOUTPUT/PHONE.RSC')**

Store all of the resources needed to view and print the file in a stream file called PHONE.RSC in the directory MYOUTPUT. The types of resources to store in this file are specified in **Resource Data** (RSCDTA).

### **IDXTRG((\* 1 '1') (5 3 'Local Telephone Charges'))**

These values together define the beginning of a new statement. (\* 1 '1') tells CRTAFPDTA to look in every record until it finds a 1 in column one. This is the indexing anchor record because it is specified first. (5 3 'Local Telephone Charges') tells CRTAFPDTA to look in the third column of the fifth record from the indexing anchor record for the phrase "Local

Telephone Charges". If both of these are found, this is the first page of a new statement. The new statement includes all of the following pages until the next trigger is found.

#### **IDXTAGFLD((1 2 20) (1 76 3) (1 81 8) (3 3 12) ("Telephone Bill"))**

These are the fields that are indexed. These fields contain the customer's name, area code, phone number, and bill date, respectively. They are all specified based on the indexing anchor record, where the indexing anchor record is considered record number one. For example, (1 2 20) tells CRTAFPDTA that the first index tag field is in the second column of the first record after the indexing anchor record and is 20 characters long.

The last entry, ("Telephone Bill"), is an example of using a literal value to index. Instead of pointing to a field to use, it adds the phrase "Telephone Bill" to the index on each phone bill.

#### **IDXTAG(("NAME" (\*IDXTAGFLD1)) ("AREA" (\*IDXTAGFLD2)) ("PHONE" (\*IDXTAGFLD3)) ("DATE" (\*IDXTAGFLD4)))**

This gives meaningful names to the tag fields defined in **Index field definition** (IDXTAGFLD). The first indexing tag specifies the customer's name, so it is labeled NAME, and so on. Notice that NAME and PHONE are the most unique indexing tags. You would use one of these values if you wanted to use the **Select index for group names** (IDXGRP) parameter. IDXGRP uses NAME by default because it is the first index tag.

#### **IDXCDEPAG(500)**

Use code page 500 for the index values and attribute names produced by CRTAFPDTA.

#### **RSCDTA(\*FORMDF \*PAGSEG \*OVL)**

Copy the form definition, the page segments, and the overlays that are needed to process this file into the resource stream file.

#### **TOMRGSTMF(/MYOUTPUT/PHONE.MRG' \*DLTINPUT)**

Merge PHONE.AFP, PHONE.RSC, and PHONE.IDX together. Name the new file PHONE.MRG and store it in the directory MYOUTPUT, then delete PHONE.AFP, PHONE.RSC, and PHONE.IDX.

Default values are used for the parameters that are not listed above.

### **Viewing the Indexed Output**

After you run the command shown in Figure 11 on page 32, you can open the file with AFP Viewer. In AFP Viewer, you can select a statement based on its values for one or more of these groups:

- NAME
- AREA (area code)
- PHONE
- DATE (month bill was issued)

For example, if you specify June for DATE and 214 for AREA, you get a list of all of the June statements for customers in area code 214. Double-click one of those statements to view it. For more information about using AFP Viewer, refer to *iSeries Guide to Output*.

---

## E-mailing the CRTAFPDTA Output

This section describes how to use CRTAFPDTA with the PDF subsystem to split and e-mail indexed output. The PDF subsystem can take a spooled file, transform it into PDF files (one for each group), and e-mail each file to the appropriate receiver. If you want to group a spooled file with its resources and e-mail it without indexing the file first, you do not need to use CRTAFPDTA. Follow the instructions in “Example” on page 66.

### How it Works

1. CRTAFPDTA creates a Begin Named Group (BNG) structured field for each group defined by the **Index trigger definition** (IDXTRG) values. The BNG Groupname is the value specified through the **Select index for group names** (IDXGRP) and **Index tag definition** (IDXTAG) parameters. Groupname is used as the routing tag, so the group names must be either all e-mail addresses or all keywords. Use a mapping program to map a keyword to an e-mail address.
2. When the file is sent to print on a properly configured device, the file is split at each BNG structured field. A PDF file is then created for each group.
3. If a mapping program is specified on the PSF configuration object, the BNG Groupname value associated with each group should be a keyword. The keywords are interpreted by the mapping program, which returns one or more valid e-mail addresses to which the file will be sent.
4. Each file is e-mailed using the protocol specified on the PSF configuration object.

### Steps to E-mail the Output

**Before you begin:**

Before you can successfully e-mail the indexed CRTAFPDTA output, you must have these:

- An appropriate PSF configuration object. The PSF configuration object must have these parameters specified:

<b>Generate PDF output</b>	*YES
<b>Multiple PDF files</b>	*YES *SPLIT
<b>PDF user program (optional)</b>	<i>mapping-program-name</i>
	<b>Library</b> <i>mapping-program-library</i>
<b>User resource library list (optional)</b>	*JOBLIBL, *CURLIB, or *NONE

For information about creating the PSF configuration object, see “Setting up Your PSF Configuration Object” on page 63.

- A properly configured device. The device must be configured to use the PSF configuration object defined above. See “Configuring the Device” on page 64 for instructions.
- (optional) A mapping program. You can create a mapping program to map routing tags that are not valid e-mail addresses to valid e-mail addresses. For information about creating a mapping program, see Appendix B, “Mapping Program,” on page 177 and Appendix C, “Templates,” on page 209.

**To e-mail the CRTAFPDTA output, follow these steps:**



1. Use CRTAFPDTA to index the file. This inserts group tags in the file. See “Indexing with CRTAFPDTA” on page 29 for an example. Be sure that you specify these:
  - Use **Select index for group names** (IDXGRP) to specify the routing tags. You must ensure that these are either all e-mail addresses or all keywords. Keywords are mapped to e-mail addresses by a mapping program. The example referenced above accepts the default value for **Select index for group names** (IDXGRP). The default value is the first **Index tag definition** (\*IDXTAG1), which is NAME in the example.
  - Use the **To stream file** (TOSTMF) parameter to specify that the output from the command is stored in QSYS.LIB as a physical file member.
  - Use **To index stream file** (TOIDXSTMF) to build the index. Specify TOIDXSTMF(\*DFT).
  - Use **Generate group names** (IDXGRPNAM) to specify that unique group names are not generated. Specify IDXGRPNAM(\*NO). If you do not specify this value, an 8-character numeric string is appended to the group name.
2. Use PRTAFPDTA to spool the AFP stream file (TOSTMF), then send it to print. The device you send it to must be set up to transform and e-mail IPDS files. See “Configuring the Device” on page 64 for instructions.

## Example

This example shows a file being split and e-mailed with CRTAFPDTA and the PDF subsystem. The file and indexing parameters from “Indexing with CRTAFPDTA” on page 29 are used. It uses a mapping program that maps customer names to e-mail addresses. Specify the mapping program in the PSF configuration object on the PDFMAPPGM parameter.

1. Index the file. This inserts the appropriate group tags. The value for NAME is used as the group name by default because it is the first indexing tag. The group name is specified by the **Select index for group names** (IDXGRP) parameter. The group name (in this case, NAME) is used as the routing tag. Because the routing tag is not a valid e-mail address, we need to use a mapping program to map the names to the appropriate e-mail addresses. The user writes this program. MYLIB/MYOUTPUT must be a physical data file and must exist prior to running the CRTAFPDTA command. The member does not need to exist. If it does, it will be replaced by the new output.

```

CRTAFPDTA
FROMSPLF(PHONE)
TOSTMF('QSYS.LIB/MYLIB.LIB/MYOUTPUT.FILE/PHONEAFP.MBR')
SPLNBR(*LAST)
FORMDF(*SPLF)
PAGDFN(*SPLF)
TOIDXSTMF(*DFT)
IDXTRG((* 1 '1') (5 3 'Local Telephone Charges'))
IDXTAGFLD((1 2 20) (1 76 3) (1 81 8) (3 3 12) ('Telephone Bill'))
IDXTAG(('NAME' (*IDXTAGFLD1)) ('AREA' (*IDXTAGFLD2))
('PHONE' (*IDXTAGFLD3)) ('DATE' (*IDXTAGFLD4)))
IDXGRPNAM(*NO)

```

2. Send the output AFP file to print on an appropriately configured device. See “Configuring the Device” on page 64 for instructions about setting up the device. In this example, PRINTER is an appropriately configured device and the form definition is the same one specified in the file PHONE’s spooled file attributes:

**Example**

```
PRTAFPDTA FILE(MYLIB/MYOUTPUT) MBR(PHONEAFP) DEV(PRINTER)
FORMDF(*LIBL/F1BILL)
```

**E-mail Considerations**

When you e-mail the output from CRTAFPDTA, you should note this:

- The spooled file attributes for the original spooled file are not associated with the output files from CRTAFPDTA.
- When the output from CRTAFPDTA is printed, PSF looks for the resources in the library list, unless otherwise specified on the PSF configuration object **User resource library list** (USRRSCLIBL) parameter.

**CRTAFPDTA and ACIF**

CRTAFPDTA implements functionality available to other platforms with ACIF. You can find more information about using the functions available through the CRTAFPDTA command in *AFP Conversion and Indexing Facility: User's Guide*, S544-5285.

This section contains two tables that list the CRTAFPDTA and ACIF parameters. Table 1 lists the CRTAFPDTA parameter first then lists the equivalent ACIF parameter (if one exists). Table 2 on page 37 lists the ACIF parameter first then lists the equivalent CRTAFPDTA parameter (if one exists).

*Table 1. CRTAFPDTA Parameters and Equivalent ACIF Parameters*

CRTAFPDTA Parameter	ACIF Parameter
AFPCHARS	CHARS
CTLCHAR - Cannot be specified directly to CRTAFPDTA. The value is obtained from the spooled file attribute CTLCHAR.	CC and CCTYPE
FORMDF	FORMDEF and FDEFLIB
FROMSPLF, JOB, SPLNBR, JOBSYSNAME, CRTDATE	INPUTDD
IDXCDEPAG	CPGID
IDXGRP	GROUPNAME
IDXGRPNAME	UNIQUEBNGS
IDXOBJ	INDEXOBJ
IDXPAGLMT	INDEXSTARTBY
IDXPAGNAM	DCFPAGENAMES
IDXTAG	INDEX <sub>n</sub>
IDXTAGFLD	FIELD <sub>n</sub>
IDXTRG	TRIGGER <sub>n</sub>
IGCSOSI - Cannot be specified directly to CRTAFPDTA. The value is obtained from the spooled file attribute IGCSOSI. <ul style="list-style-type: none"> <li>• IGCSOSI(*YES) = PRMODE(SOSI1)</li> <li>• IGCSOSI(*NO) = PRMODE(SOSI2)</li> <li>• IGCSOSI(*RIGHT) = PRMODE(SOSI3)</li> </ul>	PRMODE
IMAGEOUT	IMAGEOUT

Table 1. CRTAFPDTA Parameters and Equivalent ACIF Parameters (continued)

CRTAFPDTA Parameter	ACIF Parameter
PAGDFN	PAGEDEF and PDEFLIB
RSCDTA	RESTYPE
TBLREFCHAR - Cannot be specified directly to CRTAFPDTA. The value is obtained from the spooled file attribute TBLREFCHAR.	TRC
TOIDXSTMF	INDEXDD
TOMRGSTMF	N/A
TOSTMF	OUTPUTDD
TORSCSMTF	RESOBJDD

Table 2. ACIF Parameters and Equivalent CRTAFPDTA Parameters

ACIF Parameter	CRTAFPDTA Parameter
CC	Cannot be specified directly to CRTAFPDTA. The value is obtained from the spooled file attribute CTLCHAR.
CCTYPE	Cannot be specified directly to CRTAFPDTA. The value is obtained from the spooled file attribute CTLCHAR.
CHARS	AFPCHARS
COMSETUP	Not supported
CPGID	IDXCDEPAG
DCFPAGENAMES	IDXPAGNAM
FDEFLIB	Library portion of FORMDF
FIELD <sub>n</sub>	IDXTAGFLD
FONTECH	This parameter is not supported. Irrelevant for iSeries.
FONTLIB	This parameter is not supported. The requestor's library list is used for resource searches. The library list is augmented by the font libraries, if necessary.
FORMDEF	FORMDF
GROUPNAME	IDXGRP
IMAGEOUT	IMAGEOUT
INDEXDD	TOIDXSTMF
INDEX <sub>n</sub>	IDXTAG
INPUTDD	FROMSPLF, JOB, SPLNBR, JOBSYSNAME, CRTDATE
INDEXOBJ	IDXOBJ
INDEXSTARTBY	IDXPAGLMT
INDEXEXIT	Not supported
INPEXIT	Not supported
INPUTDD	FROMSPLF, JOB, SPLNBR, JOBSYSNAME, CRTDATE

Table 2. ACIF Parameters and Equivalent CRTAFPDTA Parameters (continued)

ACIF Parameter	CRTAFPDTA Parameter
MCF2REF	This parameter is not supported. CRTAFPDTA uses a value of CF for this parameter.
OBJCONLIB	Not supported
OUTEXIT	Not supported
OUTPUTDD	TOSTMF
OVLVLIB	This parameter is not supported. The requestor's library list is used for resource searches. The library list is augmented by the font libraries, if necessary.
PAGEDEF and	PAGDFN
PDEFLIB	Library portion of PAGDFN
PRMODE	Cannot be specified directly to CRTAFPDTA. The value is obtained from the spooled file attribute IGCSOSI. <ul style="list-style-type: none"> <li>• IGCSOSI(*YES) = PRMODE(SOSI1)</li> <li>• IGCSOSI(*NO) = PRMODE(SOSI2)</li> <li>• IGCSOSI(*RIGHT) = PRMODE(SOSI3)</li> </ul>
PSEGLIB	This parameter is not supported. The requestor's library list is used for resource searches. The library list is augmented by the font libraries, if necessary.
RESEXIT	Not supported
RESFILE	Not supported
RESOBJDD	TORSCSMF
RESTYPE	RSCDTA
TRACEDD	Not supported. i5/OS provides the facility to perform a job trace. A job trace is equivalent to the trace provided by ACIF.
TRC	Cannot be specified directly to CRTAFPDTA. The value is obtained from the spooled file attribute TBLREFCHAR.
TRIGGERn	IDXTRG
UNIQUEBNGS	IDXGRPNAME
USERLIB	Not supported

---

## Chapter 3. Transforming Image Data to AFP

This chapter describes how to install and use the `gif2afp`, `tiff2afp`, and `jpeg2afp` commands. These commands are referred to as `xxxx2afp` and the transforms are referred to as image to AFP transforms. The chapter contains these sections:

- “Syntax”
- “Overview of `xxxx2afp`”
- “Installing the Image Transforms” on page 41
- “Planning for `xxxx2afp`” on page 41
- “Parameters” on page 44
- “Transforming Image Data to AFP” on page 54
- “Error Recovery” on page 56
- “Limitations” on page 57
- “Acknowledgments” on page 57

---

### Syntax

```
xxxx2afp [-a ImageType] [-alg ProcessingAlgorithms]
[-calib calibration] [-C ConfigurationFile]
[-choice3 ImageChoice] [-clean2 cleanup] [-cmp2 compression]
[-crop CropFactors] [-fit {trim | scale}]
[-force1][-gcorr GrayscaleMappingTable] [-ink2 color] [-inv2]
[-j ScanOffsetFileName] [-l ImageLength ]
[-M MemoryBound] [-mp3 | -nomp3]
[-ms space] [-msf SpaceFraction]
[-o OutputFile] [-outbits NumberOfOutputBits]
[-outcolor OutputColorModel] [-p PageRange]
[-pagetype PageType] [-paper PaperSize]
[-r resolution] [-respath ResourceSearchPath]
[-rot rotation] [-scale ImageSize]
[-sgcorr ScannerCorrection]
[-sniff2 | -nosniff2] [-term | -noterm]
[-thresh HalftoneFile] [-v | -nov] [-w ImageWidth]
[-wrkdir1 WorkDirectory][-x LeftMargin] [-y TopMargin] [-z]
[file]
```

Figure 12. `xxxx2afp` command syntax

---

### Overview of `xxxx2afp`

The `xxxx` to AFP transform is a command controlled transform that converts graphics interchange format (GIF), Joint Photographic Experts Group (JPEG), or tagged image file format (TIFF) data to an AFP overlay, page segment, image, or document, or to a Postscript Level 2 data stream file. Use the `pagetype` parameter to specify the type of output you want. You can use either of these tools to turn the output AFP resource (overlay or page segment) into a resource on the i5/OS:

- 
1. Valid for `jpeg2afp` and `tiff2afp` only.
  2. Valid for `gif2afp` and `tiff2afp` only.
  3. Valid for `tiff2afp` only.

- iSeries Access. Refer to *iSeries Guide to Output* for instructions.
- i5/OS commands. See “Turning a PC AFP Resource into an i5/OS Resource” on page 175.

The transform can process these types of images:

- The transform processes bilevel (black and white), grayscale and color GIF images. GIF files can contain multiple images.
- JPEG images compressed using baseline lossy JPEG compression. Only 8 bits per channel and Huffman coding are supported.
- bilevel (black and white), grayscale and color extended TIFF Revision 6.0 images. TIFF files can contain multiple images. If page numbers are available in the TIFF data, the pages are sorted in this order. The pages are not sorted across file boundaries.

The output is bilevel, 4-bit or 8-bit grayscale, or 24-bit YCbCr color. The transform automatically uses halftoning to convert the grayscale and color images to bilevel.

TIFF images are often divided into many segments for efficient memory handling. Some printers terminate the printing in error if a page is too complex. For this reason, `tiff2afp` decompresses, re-partitions, and compresses the data if it deems that there are too many segments in the image.

This transform runs on Windows NT service pack 4, Windows 2000, Windows 98 and Windows 95.

## Output Data Types

The output data stream is MO:DCA™ IS/1, MO:DCA IS/2, or PostScript Level 2. Use the `-a` option to specify the output data stream type. IS/1 images are bilevel and are encoded as IOCA Function Set (FS) 10 or IM1. IM1 images are uncompressed. IOCA FS10 output images can be uncompressed or compressed by one of the four available compression algorithms (see the `-cmp` option).

IS/2 images can be either bilevel, 4-bit or 8-bit grayscale, or 24-bit YCbCr color. IS/2 images are encoded as IOCA FS11, FS42, or FS45. Multi-bit images are encoded as IOCA FS11 or FS45.

PostScript Level 2 images can be uncompressed or ITU-T T.6 Group 4 bilevel, uncompressed 8-bit grayscale or uncompressed 24-bit RGB color. By default, the transform leaves scaling and halftoning to the printer. That is, color TIFF images are output as 24-bit RGB color images.

If the input image is grayscale or color and the output image type is bilevel, the transform internally scales the image to the desired size first. It then uses a halftoning algorithm to convert it to bilevel.

## Scaling

To maintain image quality, scaling is done before halftoning. The options `-alg`, `-clean2`, and `-ink2` control scaling algorithms. The size and position of output image depend on several factors:

- The size specified to the transform
- The form map specified at print time
- Forms and options that are loaded in the printer

If the image is too large for page, it is cropped by default. You can override this with the **-fit scale** option. If paper size is not specified, the default paper size is increased to fit the image.

To explicitly specify the image size, use **-scale**. **-scale orig** forces the output image to be the same size as the original image in most cases. An image has to be scaled if the original image is being halftoned or has different resolutions in the X and Y directions (non-square pixels). By default, the transform leaves scaling to the printer. There are two exceptions:

- Images that are being halftoned, which are always scaled in the transform
- Images that have non-square pixels

**Note:** Because GIF, JPEG, and TIFF files do not specify resolutions, the image is assumed to have the resolution of the output device.

## Halftoning

When necessary, the transform uses a halftoning algorithm to convert the image to bilevel. When an image is converted to bilevel, the characteristics of the output device such as dot shape and dot gain must be taken into consideration. The internal grayscale mapping table is optimized for the 600-pel IBM Infoprint 4000 laser printer. The **-gcorr** option can be used to specify a different mapping of gray levels.

The **-alg** option controls halftoning algorithms. For very light or dark images, halftoning algorithms can be automatically re-calibrated. Halftoning algorithms are very computation-intensive and slow. You will notice a decrease in performance when images are halftoned.

---

## Installing the Image Transforms

In order to use the image transforms, you must install them on your PC by following these steps:

1. Right-click Network Neighborhood and select **Find Computer...** Specify the name of your i5/OS in the **Named:** field.
2. When Windows finds your i5/OS, double-click your system to display the contents.
3. Expand QIBM → ProdData → InfoprintServer → Transforms → Install → Image.
4. Double-click **setup.exe** and follow the directions.

**Note:** Installing the image transforms allows you to use the GIF to AFP, JPEG to AFP, and TIFF to AFP transforms.

---

## Planning for xxxx2afp

Before using any of the transforms, do the following:

- Set up a configuration file - optional. See “Setting up a Configuration File” on page 42.
- Set up environment variables - optional. See “Using Environment Variables” on page 42.
- Edit your Windows path - optional. See “Editing Your Windows Path” on page 43.
- Ensure that you have the proper authorities. See “Authorities” on page 43.

## Setting up a Configuration File

The configuration file is one place you can specify options for the transform. Entries are of the form *option=value*, where each pair is on a separate line and there is no dash before the option, like there is when the option is used on the command line. Unless otherwise noted, options and other syntax are the same for entries in the configuration file as for the command line arguments. You cannot specify input files in the configuration file.

The following options cannot be used in the configuration file:

- **-calib**
- **-C**

Options without values, such as **-v**, must be given the value **yes**.

Specify the configuration file on the command line with the **-C** option. If you do not specify one, the transform checks for the default configuration file **C:\Program Files\IBM Printing Systems\xxxx2afp\xxxx2afp.cfg** and uses that, if it exists.

The following is an example of a valid configuration file. It specifies that the output image is 8.5 by 11 inches and the resolution of the output device is 300 dpi. The output filename is myfile.afp and it is stored in C:\mydirectory. Verbose mode is on, and the output is a page segment. The spaces surrounding the equals (=) sign are optional, but if one is specified after the equals sign on a parameter that specifies a file name, the space is included in the file name.

```
scale = letter
r = 300
o =C:\mydirectory\myfile.afp
v = yes
pagetype = pseg
```

**Note:** Parameters specified in the configuration file are overridden by parameters that are specified on the command line.

## Using Environment Variables

You can use environment variables to specify parameters for the TIFF to AFP transform. Environment variables have the form **Variable: xxx2AFP\_option**, **Value: value**, where *option* and *value* are the same as the command line and configuration file option and value. If the option does not have a value, specify a blank surrounded by quotation marks (" ").

You cannot use **-calib** as an environment variable.

To achieve the same effect as the configuration file in the last example, add the following statements to your environment variables on your Windows system:

VARIABLE	VALUE
xxxx2AFP_scale	letter
xxxx2AFP_r	300
xxxx2AFP_o	C:\mydirectory\myfile.afp
xxxx2AFP_v	" "

To edit your Windows environment variables, except with Windows 98, follow these steps:

1. Right-click **My Computer** and select **Properties**.
2. Select the **Environment** page.



3. Specify the parameters you want by repeating these steps as many times as necessary:
  - a. Fill in **Variable** and **Value** for the parameter you want to use.
  - b. Click **Set**.
4. Click **Apply**.
5. Restart your computer for the changes to take effect.

To edit your Windows environment variables for the current session with Windows 98, follow these steps:

1. Open a DOS prompt.
2. Specify the parameters you want by entering this command as many times as necessary: `set variable=value`. For example to set TIFF2AFP\_scale to letter, specify `set TIFF2AFP_scale=letter`.
3. Exit the DOS command prompt.

To edit your Windows environment variables for every session, put the lines described in step 2 in your Autoexec.bat file.

**Note:** Environment variables are overridden by parameters that are specified in the configuration file or on the command line.

## Editing Your Windows Path

If you put the directory that contains the transform executable in your Windows path, you can run the transform command from any directory. If you installed the transforms in the default directory and you run the transforms from the C directory, you do not have to edit the path. Follow these steps to edit the path, except with Windows 98.

1. Right-click **My Computer** and select **Properties**.
2. Select the **Environment** page.
3. In the System Variables area, click on the current path.
4. Add the new path to the end in the format `VALUE1;VALUE2;`. For example, if you installed the transforms in the default directory, add this to the end of the current path: `c:\Program Files\IBM Printing Systems\bin;`
5. Click **Apply**.
6. The changes take effect immediately.

To edit your path with Windows 98, follow these steps:

1. Open `C:\Autoexec.bat` in an editor.
2. Add this line to the end of the file: `SET PATH=directory;`. For example, if you installed the transforms in the default directory, add this to the end of the file: `SET PATH=c:\Program Files\IBM Printing Systems\bin;`

## Authorities

You need these authorities to use this transform:

- Input file – read authority
- Output file – write authority

---

## Parameters

This section describes how to use the `xxxx2afp` parameters. These parameters apply to all three image transforms unless otherwise specified.

**-a {ioca | ioca10 | ioca11 | ioca42 | ioca45 | im1 | PS.2}**

Specifies the output image type. See also **-alg**.

**ioca** The output image type is IOCA FS10.

Make sure that your printer supports IOCA before choosing this value. If your printer does not support IOCA, choose **im1**.

**ioca10** The output image type is IOCA FS10.

Make sure that your printer supports IOCA before choosing this value. If your printer does not support IOCA, choose **im1**.

**ioca11** The output image type is IOCA FS11. IOCA FS11 cannot be used with an IPDS printer.

**ioca42** The output image type is IOCA FS42.

Make sure that your printer supports IOCA before choosing this value. If your printer does not support IOCA, choose **im1**.

**ioca45** The output image type is IOCA FS45.

Make sure that your printer supports IOCA before choosing this value. If your printer does not support IOCA, choose **im1**. If you use this value, JPEG is the default output compression type and the image is subsampled to 300 dpi. If **-cmp lzw** is specified, tLZW is used to compress the image and it is not subsampled.

**im1** The output image type is IM1.

IM1 images are uncompressed and therefore use more space. The processing might also take longer because IM1 images cannot be scaled by the printer and internal scaling algorithms are used.

**PS.2** The output image type is PostScript Level 2.

**-alg {afp | alg1 | alg2 | alg3}, {htod1 | htfs}, [ htca1 ]**

Specifies scaling and halftoning algorithms. You can specify multiple values, separated by commas, for one **-alg** option. The effect is the same as specifying multiple **-alg** options. For example, `-alg htfs,htca11` is equivalent to `-alg htfs -alg htca11`.

The following values specify scaling algorithms:

**afp** Scaling is done by the default algorithm in the printer. This makes the transform faster. If the image must be reduced, however, this algorithm might lose some image information, such as thin lines. This value is the default for bilevel images with IOCA output.

**alg1** Scaling is done by the internal scaling algorithm. This algorithm will not discard any ink in the image. White space in the image, however, might be lost. This algorithm makes the transform run longer. This value is only valid for GIF and TIFF images.

**alg2** Scaling is done by a more flexible version of **alg1**. If this value is selected, **-clean** can be used to specify the amount of ink cleanup that is performed. This value is only valid for GIF and TIFF images.

**alg3** Scaling is done by a scaling algorithm that works by deleting or

duplicating rows and columns in the image. This is a fast general-purpose algorithm. This value is the default for bilevel images with IM1 output. This value is only valid for GIF and TIFF images.

The following values specify halftoning algorithms. Each halftoning algorithm uses a different internal default calibration curve. If automatic calibration is turned on, a different set of calibration curves is used.

**htod1** Halftoning is done using an ordered dither with a screen derived from the value of the **-thresh** option. The default is an 85 line per inch screen.

**htfs** Halftoning is done by the Floyd-Steinberg algorithm.

**htcal1** Re-calibrates the halftoning algorithm for each image. **htcal1** forces the transform to read the whole image into memory and requires an additional pass through the image. It should be used only for very light or very dark images.

See also **-clean**, **-gcorr**, **-ink**, **-paper**, **-scale**, **-thresh**, **-l**, **-w**, **-x**, and **-y**.

**-calib {scanner | printer | patch | patchr}, name1...**

Specifies the transform calibration for the scanner or printer. You cannot specify **-calib** in the configuration file or as an environment variable.

**scanner** The file is calibrated for the scanner. If this value is specified, you must also specify **-sgcorr**.

**printer** The file is calibrated for the printer.

**patch** If this value is specified, any value specified for **-sgcorr** is ignored.

**patchr** If this value is specified, any value specified for **-sgcorr** is ignored.

*name1* Specifies the name of the file being calibrated. You can specify multiple files.

**-choice {full | reduced | both }**

TIFF image files can contain both full and reduced resolution versions of each image. This option specifies which type of image the transform outputs. See also **-mp** and **-nomp**. This parameter is only valid for the TIFF transform.

**full** The transform outputs the full resolution images only.

**reduced** The transform outputs the reduced resolution images only.

**both** The transform outputs both the full and reduced resolution images.

**-C ConfigurationFileName**

Specifies the name of a configuration file. If multiple **-C** options are given on the command line, they are processed in the order in which you specified them. The default configuration file is **C:\Program Files\IBM Printing Systems\tiff2afp\tiff2afp.cfg**.

*ConfigurationFileName*

The name and location of a configuration file. If there are spaces in the file name, enclose the file name in double quotation marks.

**-clean {0.5 | x.xxx}**

This parameter is only valid for the GIF and TIFF transforms. It specifies when to turn on a pel. The scaled pel is turned on if the specified part of its area, defined by the threshold, is painted in the original image. The threshold is the

value **0.5** or *x.xxx*. It is a decimal that defines a fraction. If the fraction of a pel that is painted in the original image is greater than this threshold, the pel is turned on. For example, if you specify **-clean .4**, a pel is turned on any time more than 4 tenths, or 20%, of the pel is painted in the original image. This option is only used if **-alg alg2** is specified.

**0.5** The threshold is .5. **alg2** turns on a pel any time more than half of it is painted in the original image.

*x.xxx* The threshold is *x.xxx*. *x.xxx* is a number in the range of 0-1.

If **-clean 0.0** is specified, **alg2** turns on a pel any time any part of the pel is painted in the original image. Therefore, it behaves like **alg1**.

**-clean 1.0** turns on a pel when more than 100% of the pel is painted in the original image; therefore, it results in a blank image.

**-cmp {g4 | none | lzw | mh | mmr | g3 | jpeg | abic }**

Specifies the output image compression algorithm. This parameter is only valid for the TIFF transform.

**g4** ITU-T T.6 Group 4 algorithm. This is the default compression for bilevel images. Make sure that your printer supports the Group 4 compression algorithm before specifying this value.

**lzw** Lempel-Zif-Welch algorithm.

**none** The output is uncompressed. This is the default for non-JPEG grayscale and color images.

**mh** ITU-T T.4 Group 3 Modified Huffman algorithm

**mmr** IBM Modified Modified Read algorithm

**g3** ITU-T T.4 Group 3 Modified Read algorithm

**jpeg** JPEG nondifferential Huffman coding with baseline DCT algorithm. This algorithm can only compress 8-bit grayscale and 24-bit color images.

**abic** ABIC algorithm

**-crop *t,b,l,r* [ d | i | m | p ]**

Specifies how much the image is cropped. Cropping is done in the context of the output page, so that "top" means the top of the output page, regardless of the **-rot** option. The resulting image has the size specified by the **-scale** option. If you want the image cropped from at least one direction, you must specify all of the commas. For example **-crop ,5,,4** and **-crop 0,5,0,4** tell the transform to crop the image five dots from the bottom and four dots from the right. **-crop 5,4** gives you an error. See also **-j**.

The following values specify the amount of cropping:

*t* Specifies how much should be cropped from the top edge. Designate a positive or negative decimal value. A negative number indicates that a blank space is inserted.

*b* Specifies how much should be cropped from the bottom edge. Designate a positive or negative decimal value. A negative number indicates that a blank space is inserted.

*l* Specifies how much should be cropped from the left edge. Designate a positive or negative decimal value. A negative number indicates that a blank space is inserted.

*r* Specifies how much should be cropped from the right edge. Designate a positive or negative decimal value. A negative number indicates that a blank space is inserted.

The following values specify the unit of measurement:

**d** Measurements are in dots (pels).

**i** Measurements are in inches.

**m** Measurements are in millimeters.

**p** Measurements are in points.

**-fit {trim | scale}**

Specifies what the printer does when the image is too large to fit on the paper. Specify paper size with the **-paper** option.

**trim** The image is positioned and then trimmed to make it smaller.

**scale** The image is scaled to make it smaller.

**-force**

Specifies that the transform decompresses and recompresses the image, regardless of other factors. This parameter is only valid for the JPEG and TIFF transforms.

**-gcorr *FileName***

Specifies a file that contains a grayscale mapping table for halftoning grayscale and color images. The mapping table must be provided to compensate for the printing characteristics of the particular output device and paper type, such as dot gain. This file must contain one of these:

- 256 real numbers, one for each level of gray in the 8-bit grayscale image
- The PostScript **settransfer** operator

The algorithm converts every image to 8-bit grayscale before applying the halftoning algorithm. The default internal mapping table is optimized for the 600-pel IBM Infoprint 4000 laser printer. Only experienced users should change this. PostScript code submitted by the **-thresh** option can have the same effect as **-gcorr**. See also **-alg** and **-thresh**.

*FileName* Specifies the name and location of a file that contains a grayscale mapping table. If there are spaces in the file name and you are specifying this value on the command line, enclose the file name in double quotation marks.

**-ink { black | white }**

Specifies whether the transform preserves black or white pels when compressing. The internal scaling algorithm must know which, because “ink” is preserved at the expense of “non-ink” This parameter is only valid for the GIF and TIFF transforms and is used only with scaling algorithm **alg1** or **alg2**.

If the option **-inv** is used to print the reversed image, the inversion is done as the data is read by the transform, before any processing is done. Therefore, black or white must be specified in the terms of the printed image, not in the terms of the input TIFF image.

**black** The image is black on white.

**white** The image is white on black.

**-inv**

Reverses the image. Areas that are black in the original image become white

and vice versa. Note that the reversed image might be black on white or white on black, depending on the original image. This parameter is only valid for the GIF and TIFF transforms.

**-j** *ScanOffsetFileName*

Specifies the name of the scan offset file. Sometimes input images must be shifted to get the desired positioning on the page. The scan offset file contains the directions for shifting such images. The file has this format:

```
[attribute]
values
.
.
.
values
[attribute]
values
.
.
.
values
```

These are the recognized attributes:

**[Units]**

Allowed values are: millimeters, **mm**, **inches**, **in**, **points**, **dots**, and **pels**

**[Page\_Offset\_Type]**

Allowed values are: **crop** and **grow**

**[Page\_Offsets]**

The values are in the format *FileName*, **H***horiz*, **V***vert* Each entry refers to an input file. The file names or leading commas must be specified but are currently ignored. The offset factors are applied to each file in turn. The same factors are applied to each image in the file. The *horiz* and *vert* values are the amount that the image is shifted in the horizontal and vertical directions. The positive directions are down and right, the origin is in the left upper corner of the page. The shifts are specified context of the output page.

Extra spaces and blank lines are allowed. Unrecognized attributes and their values are ignored.

If the image is moved left or up, part of the bitmap is removed. If the image is moved down or right, removal is governed by the value of the **[Page\_Offset\_Type]** attribute.

**-l** **{11i | length[d | m | i | p]}**

Specifies the paper length. See also **-w** and **-paper**.

**11i** The paper is 11 inches long.

*length* Specifies the length of the paper. Give the length in decimal format.

The following values specify the unit of measurement:

**d** The length is measured in dots. This value only uses the whole number part of a decimal value.

**m** The length is measured in millimeters.

**i** The length is measured in inches.

**p** The length is measured in points.

**-lut** *FileName*

Specifies the color mapping look up table. The table must be appropriate for the file's color type. For example, if your file is RGB, the look up table must be for RGB mapping.

*FileName*

Specifies the name and location of the file that contains the look up table. If there are spaces in the file name and you are specifying this value on the command line, enclose the file name in double quotation marks.

**-M** { 0 | *nnn* }

Specifies the amount of memory available to **tiff2afp**.

0 There is no memory limit.

*nnn* Specifies the maximum amount of memory allocated to **tiff2afp**, in kilobytes. *nnn* is a value in the range of zero to the maximum value that Windows allows.

[ **-mp** | **-nomp** ]

Each TIFF image is supposed to have a marker bit set if there are multiple pages in the file. This marker is sometimes missing, even if there are multiple pages in the file. This option specifies whether the marker is present. This parameter is only valid for the TIFF transform.

**-mp** The transform behaves as if the marker is set. The transform processes all the pages in the file, regardless of the marker bit.

**-nomp** The transform looks for the marker bit. All the pages of multi-page TIFF file are processed only if the marker bit is set in the file. If there is a multi-page TIFF file without the marker bit set, only the first page is processed.

**-ms** { 10 | *nnn* }

Specifies the amount of disk space that must be available on the file system that contains the output file. This limit is enforced every time data is written to the output file. If the output is stdout, this option is ignored. See also **-msf**.

10 There must be at least 10 kilobytes of disk space available on the file system that contains the output file.

*nnn* There must be at least *nnn* kilobytes of disk space available on the file system that contains the output file.

**-msf** { 0.1 | *x.xxx* }

Specifies the minimum amount of available space that must be on the file system containing the output file. The space is given as a fraction of the total space in the file system. This limit is enforced every time data is written to the output file. If the output is stdout, this option is ignored. The default is **0.1**. See also **-ms**.

0.1 One-tenth of the total space in the file system must be available.

*x.xxx* Specifies a number in the range of 0-1 that designates the portion of the space that must be available.

[ **-nomp**

See [ **-mp** | **-nomp** ]

[ **-nosniff** | **-sniff** ]

Specifies whether bilevel images are automatically converted to black on white. The conversion algorithm determines the number of black and white bits. If

there are fewer white bits, it assumes that the image is white on black, and inverts the image to be black on white. This algorithm is run after the conversion specified by the Photometric Interpretation tag is applied (if any).

This option is ignored if the image is not bilevel and is only valid for the GIF and TIFF transforms.

**-nosniff** Bilevel images are not converted to black on white.

**-sniff** Bilevel images are converted to black on white.

**[-noterm | -term]**

Specifies whether error recovery is enabled. When error recovery is enabled, errors in TIFF files are treated as nonfatal. The transform tries to recover with the next image in the file. If error recovery is disabled, when the transform finds an error in a TIFF file, the transform ends with an error message and a nonzero return code.

**-noterm** Enables error recovery.

**-term** Disables error recovery.

**[-nov | -v]**

Specifies whether verbose mode is on. When verbose mode is on, the transform sends a message as it opens each resource file. It then echoes the command line and sends a message for each file name as it is processed. When verbose mode is off, the transform sends only error messages.

**-nov** verbose mode is off.

**-v** verbose mode is on.

**-o *FileName***

Specifies the output file name. This is optional. If you do not specify an output file name or request standard output, the AFP file is stored in the same location as the input file with the same name as the input file, but with .afp as the extension.

*FileName* The output file name and location. If there are spaces in the file name and you are specifying this value on the command line, enclose the file name in double quotation marks. Specify **-** or **stdout** for stdout. No file is created if you specify stdout.

If you want to use this file on your i5/OS system, specify `\\system\QDLS\file.afp`. *system* is the name of your i5/OS system and *file* is the name of the output file.

For information about importing the AFP file from your PC to your i5/OS system using i5/OS commands, see "Turning a PC AFP Resource into an i5/OS Resource" on page 175. For instructions about using iSeries Navigator to do this, refer to *iSeries Guide to Output*.

**-outbits {1 | 24 | 4 | 8 }**

Specifies the number of bits per pel in the output.

**1** The output has 1 bit per pel. If the output image type is IOCA FS10 or IM1, the number of output bits is set to 1 and this option is ignored.

**24** The output has 24 bits per pel. This is the default for IOCA FS11 output. This number represents the maximum number of bits that are used per pel. Thus, even if the number of bits is set to 24, a 4-bit grayscale image is still displayed in 4-bit format.



**4** The output has 4 bits per pel.

**8** The output has 8 bits per pel.

**-outcolor** {ycbcr | **rgb** | **ycrcb**}

Specifies the output color model. This value is ignored unless the image type (specified with **-a**) is IOCA FS11 and the number of output bits (specified with **-outbits**) is 24.

ycbcr The output color model is YCbCr.

**rgb** The output color model is RGB.

**ycrcb** The output color model is YCrCb.

**-p** {**even** | **odd** | *nn* | *nn-mm* | *nn-*}

Specifies which pages the output should contain. If no **-p** option is given, all the pages are output. You can specify **-p** multiple times. Their effect is cumulative. The pages are always printed in ascending order and are numbered starting with one.

**even** Print all even pages.

**odd** Print all odd pages.

*nn* Print page *nn*.

*nn-mm* Print pages *nn* to *mm*.

*nn-* Print all pages starting with page *nn*.

**-pagetype** {page | **overlay** | **ovly** | **pseg** | **object**}

Specifies the output page type. The same page type is set for every page in the output. However, you can use **-p** to output only specified pages. See also **-a**.

page All output is pages.

**overlay** All output is overlays.

**ovly** All output is overlays.

**pseg** All output is page segments.

**object** All output is objects.

**-paper** {letter | **a5** | **a4** | **a3** | **folio** | **legal** | **ledger** | *xxx.xx,yy.yy*[d | **m** | **i** | **p**]}

Specifies the output paper size. If the paper size is not specified, the paper size is increased, if necessary, to contain the output image.

See also **-l**, **-w**, and **-scale**.

letter 8.5 by 11 inches (216 by 279 mm)

**a3** A3 format (297 by 420 mm or 11.69 by 16.54 inches)

**a4** A4 format (210 by 297 mm or 8.27 by 11.69 inches)

**a5** A5 format (148 by 210 mm or 5.83 by 8.27 inches)

**folio** 8.5 by 13.0 inches (216 by 330 mm)

**legal** 8.5 by 14.0 inches (216 by 356 mm)

**ledger** 11.0 by 17.0 inches (279 by 432 mm)

*xxx.xx,yy.yy* [d | **i** | **m** | **p**]

Specifies the page dimensions.

*xxx.xx* Specifies the horizontal page dimension.

*yy.yy* Specifies the vertical page dimension.

The following values specify the unit of measurement:

**d** Measurements are in dots (pels).

**i** Measurements are in inches.

**m** Measurements are in millimeters.

**p** Measurements are in points.

**-r** {300 | *nnn*}

Specifies the output device resolution in dots per inch.

300 The output device resolution is 300 dots per inch.

*nnn* The output device resolution is *nnn* dots per inch.

**-respath** *directory*[:*directory*...]

Specifies the search path for resource files, such as the scan offset files and grayscale calibration curve files. If a resource file name is specified as a relative name, the transform searches every directory in the path, in the order specified in the path, until it finds the file or fails. This search path does not apply to anything in the configuration file.

*directory* Specifies the search path for resource files. The default is **C:\Program Files\IBM Printing Systems\config**.

**-rot** {0 | **90** | **180** | **270** [ **p** | **i** ]}

Specifies how far to rotate the image and where the image is rotated.

The following values specify how far to rotate the image:

0 The image is not rotated.

**90** The image is rotated clockwise 90 degrees.

**180** The image is rotated clockwise 180 degrees.

**270** The image is rotated clockwise 270 degrees.

The following values specify where the image is rotated:

**p** The printer rotates the image.

**i** The transform rotates the image. When **i** is specified, the transform takes longer to run and uses more memory.

**-scale** {orig | **a5** | **a4** | **a3** | **letter** | **folio** | **legal** | **ledger** | *xxx%* | *xxx.xx,yyy.yy* [**d** | **m** | **i** | **p**]}

Specifies the output image size. The image is scaled to this size and centered in the area defined by the paper size and margin options.

orig Preserve the input image size, regardless of the printable paper area. The image still has to be scaled if the input file specifies non-square pels or is halftoned.

**a3** A3 format (297 by 420 mm or 11.69 by 16.54 inches)

**a4** A4 format (210 by 297 mm or 8.27 by 11.69 inches)

**a5** A5 format (148 by 210 mm or 5.83 by 8.27 inches)

**letter** 8.5 by 11 inches (216 by 279 mm)

**folio** 8.5 by 13.0 inches (216 by 330 mm)

**legal** 8.5 by 14.0 inches (216 by 356 mm)

**ledger** 11.0 by 17.0 inches (279 by 432 mm)

*xxx%* Scaling is relative to the original image size. Numbers below 100% mean reduction, while numbers above 100% mean enlargement. For example, **-scale 200%** causes the output image to be twice as long and twice as wide as the input image.

*xx.xx,yy.yy***[d | m | i | p]**

Specifies the image dimensions.

*xx.xx* Specifies the horizontal dimension.

*yy.yy* Specifies the vertical dimension.

The following values specify the unit of measurement:

**d** Measurements are in dots (pels).

**i** Measurements are in inches.

**m** Measurements are in millimeters.

**p** Measurements are in points.

**-sgcorr** *FileName*

Specifies the name of the scanner-related calibration file. If **-calib** is not specified, this option is ignored.

*FileName* The name and location of the scanner calibration file. If there are spaces in the file name and you are specifying this value on the command line, enclose the file name in double quotation marks.

**-sniff**

See [**-nosniff** | **-sniff**]

**-term**

See [**-noterm** | **-term**]

**-thresh** *FileName*

Specifies a file that contains a PostScript Type 1 or Type 3 halftone dictionary. Alternatively, the PostScript code can specify the **setscreen** operator instead of a Type 1 dictionary. The halftone cell in the dictionary is used to overwrite the default ordered dither clustered dot halftone cell. If the PostScript code contains a transfer function, either in the halftone dictionary or specified by the **settransfer** operator, the current grayscale correction curve is overwritten as if **-gcorr** were used.

*FileName* The name and location of the file that contains an appropriate halftone dictionary. If there are spaces in the file name and you are specifying this value on the command line, enclose the file name in double quotation marks.

**-v** See [**-nov** | **-v**]

**-w** **{8.5i | *yyy.yy*[d | m | i | p]}**

Specifies the paper width. See also **-l** to set the paper length or **-paper** to set both dimensions at the same time.

**8.5i** The page width is 8.5 inches.

The following values specify the unit of measurement:

**d** The width is measured in dots (pels).

**i** The width is measured in inches.

**m** The width is measured in millimeters.

**p** The width is measured in points.

**-wrkdir** *WorkDirectoryName*

Input to **tiff2afp** from stdin must be cached before it can be processed. This option specifies which directory to use for caching the input. If this option is not specified, or the directory cannot be opened, the transform tries to use **C:\Program Files\IBM Printing Systems\xxxx2afp** as the working directory. If the transform cannot use **C:\Program Files\IBM Printing Systems\xxxx2afp**, it uses **C:\temp**.

The stdin cache file is not visible to the user because it is immediately unlinked after creation. Thus, the cache file is always deleted when **tiff2afp** finishes, even if it ends abnormally.

This parameter is only valid for the JPEG and TIFF transforms.

**-x** {0 | *nnn.nn*[**d** | **m** | **i** | **p**]}

Specifies the left margin.

0 There is no left margin.

*nnn.nn* The left margin is *nnn.nn* units.

The following values specify the unit of measurement:

**d** The margin is measured in dots (pels).

**i** The margin is measured in inches.

**m** The margin is measured in millimeters.

**p** The margin is measured in points.

**-y** {0 | *nnn.nn*[**d** | **m** | **i** | **p**]}

Specifies the top margin.

0 There is no top margin.

*nnn.nn* The top margin is *nnn.nn* units.

The following values specify the unit of measurement:

**d** The margin is measured in dots (pels).

**i** The margin is measured in inches.

**m** The margin is measured in millimeters.

**p** The margin is measured in points.

---

## Transforming Image Data to AFP

This section describes how to transform image data to AFP and gives examples.

### Input to the Image to AFP Transform

Input can be a GIF, TIFF, or JPEG file submitted by standard input (stdin) or specified on the command line. If no input file is specified, stdin is assumed. The extension, such as .tiff, does not need to be given explicitly. **xxxx2afp** first tries to open the file as specified and, if unsuccessful, tries to append the appropriate extension, such as .tif, .tiff, .TIF, and .TIFF.

## Specifying the Output File

The output file name and location can be derived from the input file name and location, specified on `-o`. Alternatively, you can force output to be standard output (stdout, this is typically output to your screen) by specifying `-o stdout` on the command line or `o = -` or `o = stdout` in the configuration file. If you request standard output, no output file is generated. By default, the output file has the same name as the input file and is stored in the same location as the input file.

If the output file name is not specified explicitly, the transform strips any extension from the input file name and appends the appropriate extension to create the output file name.

For example, all the following commands have `myfile.afp` as the output file:

```
xxxx2afp myfile
xxxx2afp myfile.tiff
xxxx2afp myfile -o myfile.afp
```

Note that there is no requirement for the explicitly specified input and output files to have `.tiff`, `.jpeg`, or `.gif`, and `.afp` extensions. For example, to process TIFF file `foo.bar` into an AFP file named `foo.bar2`, use this command to invoke the transform:

```
tiff2afp foo.bar -o foo.bar2
```

## Invoking the Image Transform

To invoke the image transform, go to a DOS prompt and specify `xxxx2afp file -option value.... file` is the location and name of the input file and `option value` is any parameter you want to specify on the command line. You do not have to specify any parameters on the command line. The parameter values are determined by this hierarchy (least significant first):

1. Internal defaults
2. Environment variables
3. Configuration file
4. Command-line arguments

### Notes:

1. If there are spaces in the path or name, enclose the string in double quotation marks. For example, "C:\Program Files\IBM Printing Systems\files\file.tiff".
2. If the directory that contains `xxxx2afp.exe` is not in your PATH specification, you must be in that directory to run the command. If you accepted the default directories at install time, this directory is **C:\Program Files\IBM Printing Systems\bin**. See "Editing Your Windows Path" on page 43 for instructions to change your PATH.

## Command Line Arguments

When using the command line, note the following:

- Options and input file names can be specified in any order.
- Only file names are case-sensitive.
- If an option is specified multiple times, only the last one is recognized.
- If multiple configuration files are given, they are processed in the order in which you specify them.

## Examples

### Example 1

This example transforms a TIFF file called `MyOverlay.tiff` into an AFP overlay called `MyOverlay.afp`. The output file name is not specified because it is given the same name as the input file with the `.afp` extension by default. It is stored in the specified directory so it can easily be imported to the system `MyIseries`. Enter this command at a DOS prompt:

```
tiff2afp MyOverlay.tiff -pagetype overlay -o \\MyIseries\QDLS\MyOverlay.afp
```

The same results can be achieved with this command and configuration file:

```
tiff2afp MyTiffFile.tiff -C ConfigFile1
```

`ConfigFile1` contains this:

```
pagetype=overlay  
o=\\MyIseries\QDLS\MyOverlay.afp
```

## Example 2

This example transforms a TIFF file called `BigLogo.tiff` into an AFP page segment called `LOG0`. The logo needs to be scaled down and rotated 90 degrees. To have greater control over which pels are colored, we specify the `alg2` algorithm and specify that a pel in the output is only colored if 80% of the pel was colored in the input file. However, specifying `alg2` makes the transform take longer to complete. The output is stored in the specified directory so it can easily be imported to the system `MyIseries`. Enter this command in a single line at a DOS prompt:

```
tiff2afp BigLogo.tiff -pagetype pseg -scale 2,2i -rot 90 -alg alg2 -clean .8  
-o \\MyIseries\QDLS\LOG0.300
```

The same results can be achieved with this command and configuration file:

```
tiff2afp BigLogo.tiff -C ConfigFile2
```

`ConfigFile2` contains this:

```
pagetype=pseg  
scale=2,2i  
alg=alg2  
clean=.8  
o=\\MyIseries\QDLS\LOG0.300
```

---

## Error Recovery

The transforms can encounter two types of errors; fatal and nonfatal.

When the transform finds a fatal error, the last output page might be incomplete. These are fatal errors:

- Errors in the user-specified parameters; either in the environment variables, the configuration file, or command line arguments. These errors include unrecognized options, incorrect values for parameters, or inability to open the configuration file or the output file.
- Out of memory errors. The requested memory is larger than the memory specified using the `-M` option or the dynamic memory allocation has failed.
- Disk space errors. If the file system is full, the transform deletes the partial output file before terminating. See the `-ms` and `-msf` options for setting the minimum free disk space requirements.
- Internal errors.

When the transform finds a nonfatal error in a file, the transform tries to recover with the next image in the file, and a warning message is issued. Errors and warnings are output to standard error.

A nonfatal error is made fatal if **-term** is specified. Nonfatal errors include errors that are encountered in the input files:

- The transform cannot open the input file.
- The input file is not the right type for the transform called.
- The input file contains features that cannot be processed.

---

## Limitations

All of the image transforms have these limitations:

- Only Huffman coding with baseline DCT JPEG algorithm is supported.
- At most 8-bit grayscale and 24-bit color is supported.

The TIFF to AFP transform has these additional limitations:

- Old style JPEG specification (Photometric Interpretation 6) is not supported. Use the Photometric Interpretation 7 to incorporate the JPEG compressed images in image files.
- Additional color information, such as alpha data, is disregarded.
- Transparency maps are ignored.

The GIF to AFP transform has the two common limitations listed above and these additional limitations:

- The timing data from GIF animation sequences is ignored.
- Animation sequences are processed as unrelated images.

---

## Acknowledgments

This software is partially based on the Independent JPEG Group's JPEG compression and decompression code.





---

## Chapter 4. Using the PDF Subsystem

Using the PDF subsystem, Infoprint Server can generate an output file and do any combination of these with the output:

- Send it as a PDF attachment to an e-mail.
- Store it as a PDF file in the integrated file system.
- Spool it as PDF to an output queue.
- Spool it as an AFP file to an output queue.

This is called *intelligent routing*. The PDF subsystem can also take an input file and split it into segments at group boundaries. It can then route each segment in any of the ways listed above, independent of the other segments. The input spooled file can be any type of data that PSF for i5/OS can print.

**Note:** The PDF subsystem interacts with PSF for i5/OS (hereafter referred to as PSF) to process data. However, you do not need a license for PSF to generate PDF. You do need a license for PSF to respool a spooled file as AFP.

This chapter contains this information:

“Overview” explains how the subsystem works.

“Before Using the PDF Subsystem” on page 63 explains how to set up a PSF configuration object and configure the device.

“Transforming a Spooled File to PDF” on page 65 explains how to transform a file.

“Insert Routing Tags into the Data” on page 76 explains how to use DDS or the Infoprint Server Create AFP Data command to modify your input data.

“PSF Configuration Object Parameters” on page 82 lists the PSF configuration object parameters that are related to the PDF subsystem.

“Usage Notes” on page 91 explains what differences to expect between AFP and PDF output.

“PDF Conversion Completion Data Queue” on page 95 describes a data queue that tracks when PDF conversion is complete.

“Error Recovery” on page 98 describes where errors are sent. It also lists common problems and how to fix them.

---

### Overview

To transform a spooled file to PDF, PSF and Infoprint Server work together:

1. PSF receives a spooled file, transforms it to AFP, respools it if requested, and sends it to the PDF subsystem.
2. The PDF subsystem transforms the spooled file to PDF and sends the PDF back to PSF.
3. PSF spools the PDF file for printing, e-mails it, places it in the integrated file system as a stream file, or all three. It can optionally use information from a *PDF mapping program* (hereafter referred to as a mapping program) to customize the PDF and its delivery. If you use the IBM-supplied mapping program, you create a *map object* to give output information to the IBM-supplied mapping program.

Figure 13 on page 60 illustrates this process.

A map object and mapping program are not necessary if the values available on the PSF configuration object for the PDF creation are adequate. When e-mailing the PDF output, you will have to specify valid e-mail addresses. When not using a mapping program or map object, specify the address on the USRDFNDTA field in the printer file or the spooled file, or in the data. You can use DDS keywords or the CRTAFPDTA command to specify the e-mail address in the data.

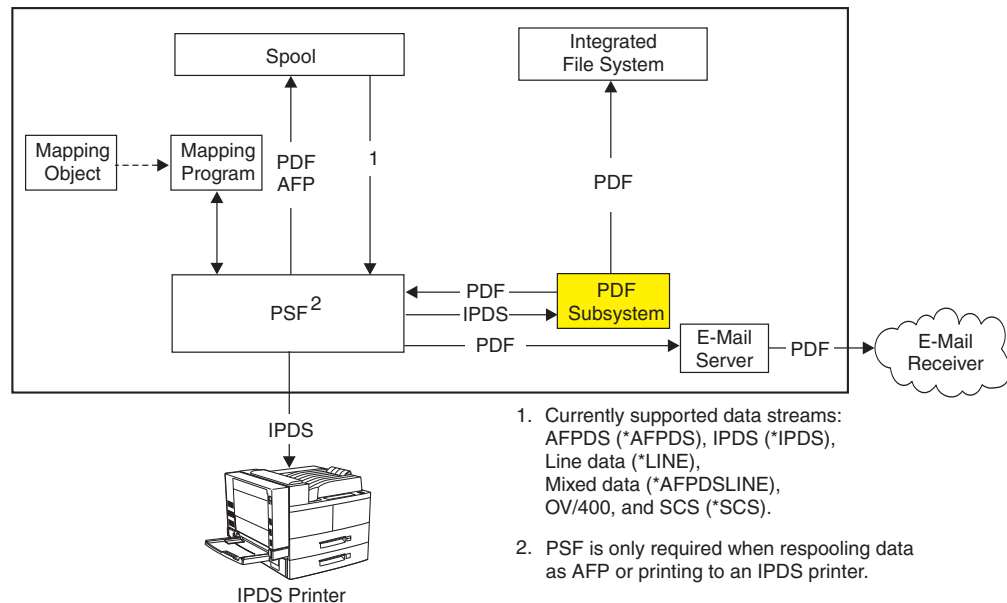

Figure 13. Transforming a Spooled File to PDF

Understanding these terms will help you understand how the PDF subsystem works:

### mapping program

A mapping program is a versatile user exit program. You can use it to specify the PDF file's name, specify where to store it in the integrated file system, and more. When sending the PDF as e-mail, you can use the mapping program to interpret your routing tags, specify the e-mail subject, specify encryption of e-mailed PDF, and add text to the beginning of each e-mail. If you use an SMTP server to send the e-mail, you can also use the mapping program to specify carbon copy (cc), blind carbon copy (bcc), and return-to addresses, a file to use as the e-mail body, and attachments.

### map object

A map object is an object you create to customize the IBM-supplied mapping program to fit your needs. You can use a menu-driven i5/OS command or the PDF map APIs to create and customize the mapping program. Using the command lets you take advantage of the options available through the mapping program without programming anything.

### routing tag

The routing tag gives a unique ID to the spooled file or a segment of the spooled file. There are several ways to use the routing tag:

- If you have no mapping program, the tag has to specify the e-mail address to which the output file should be sent.

- If you have your own mapping program, you can put any data you want in the 255 byte routing tag. You then create logic in your exit program that matches the routing tag to the distribution method and details you want.
- If you are using the IBM-supplied mapping program, you need to create a map object with an entry that maps each routing tag to the distribution information. Then you insert that matching routing tag into the data and the IBM-supplied mapping program will take care of the distribution at run time.

The use of routing tags is illustrated in Figure 14. In this figure, each segment has a routing tag; Northwest Data and Central Data. The routing tags tell Infoprint server what to do with the output.

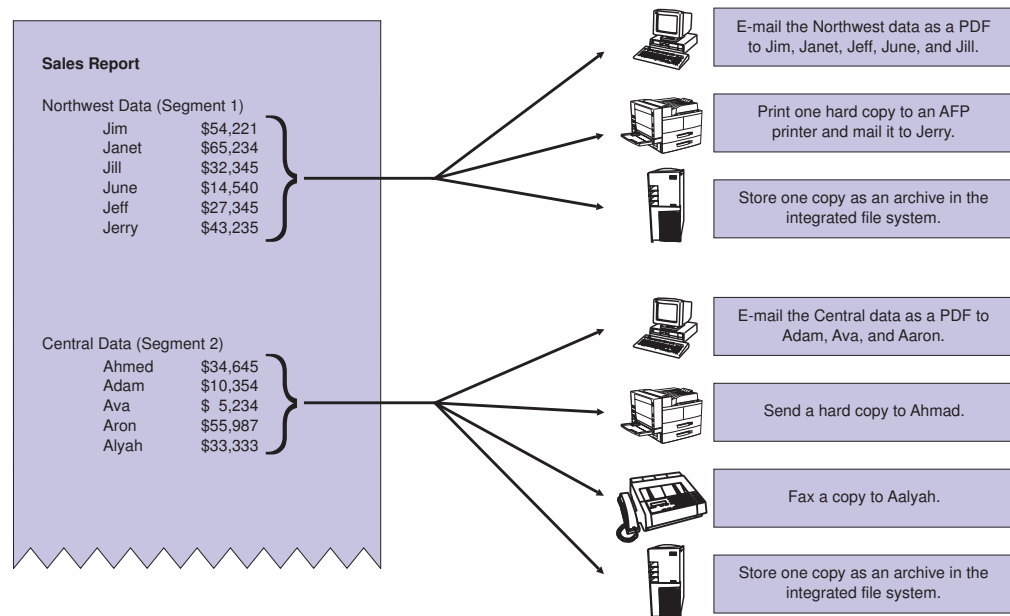

Figure 14. Routing Tags

Routing tags can come from any of these places:

- The User defined data's (USRDFNDDTA) mailtag parameter. You can specify User defined data on the printer file or add it to the spooled file after creation. To add it to the spooled file, use the Change spooled file attributes (CHGSPLFA) command.
- Index tags added with Infoprint Server's Create AFP data (CRTAFPDDTA) command. The routing tag is the value for Index tag definition (IDXTAG).
- DDS Start page group (STRPAGGRP) group names.

If the input to the PDF subsystem is text-based, the input controls and data are converted into PDF files with text, graphics, and image data. The PDF files can be used in e-mail applications, Internet-based softcopy repositories, printed on PDF printers, or all three. The transform emulates a TCP/IP-connected IPDS 4028, 3812, or Infoprint 40 printer device and the conversion takes place at print time.

All resources (fonts are optional) are embedded in the PDF file, this guarantees resource availability. All embedded 240-pel fonts and AFP resources are converted to 300 pel during conversion. This transform supports single-byte fonts and

downloaded double-byte raster fonts. Double-byte outline fonts, resident double-byte fonts, and TrueType or OpenType fonts are not supported.

**Notes:**

1. If you want to use your own IPDS to PDF transform instead of the PDF subsystem, you can use the PDF transform exit point. For information about using the PDF transform exit point, see Appendix D, "Exit Points," on page 217.
2. If the input to the PDF subsystem is an image file, the PDF output is image.
3. Any data stream transforms that occur before the input data is spooled might cause image data to be input to the PDF subsystem.

## Default Transform Characteristics

The transform output is controlled by the default transform characteristics and by the values specified in a PSF configuration object. The PDF subsystem accepts and transforms print jobs as if it was an actual IPDS printer with these basic characteristics:

- Two paper trays
- Duplex enabled
- Default output bin
- Edge-to-edge enabled. Note that this might result in different output than you would get on a printer with a no print border.

If your print job uses other options, a message is sent and the document is transformed or is cancelled. This is controlled by the document fidelity setting specified in the printer file associated with the job.

**Note:** The resulting PDF output does not contain duplex or input bin settings.

The PDF subsystem emulates an IPDS printer with these IPDS configuration settings defined in the printer. The equivalent Infoprint 11xx and 13xx settings have been included for those who are more familiar with Infoprint 11xx and 13xx settings. The Infoprint 11xx and 13xx menu items are found in the IPDS MENU menu.

*Table 3. Default IPDS Configuration Settings*

4028, 3812, or Infoprint 40 Setting	Infoprint 11xx, 12xx, or 13xx Menu Item
vpa chk = off	EMULATION/Exception Control = Sup Beyond VPA, Suppress Both, or Sup Undef char
x offset = 0	MARGINS/(paper source)/Left Margin = 0
y offset = 0	MARGINS/(paper source)/Top Margin = 0
page = whole	EMULATION/Printable Area = 4028 Whole Page
edge-edge = on	EMULATION/Printable Area = Physical Page (edge-to-edge)
font sub = on	EMULATION/Font Ctrl = Relaxed
gcs = char	No equivalent value
scal bar code = auto	No equivalent value
box draw = off	No equivalent value

Use the PDFDEVTYPE option in the PSF configuration object to specify other IPDS printer characteristics.

---

## Before Using the PDF Subsystem

This section describes what you have to do before using the PDF subsystem. In order to use the subsystem, you need to follow the instructions in these sections:

1. Optional — Create a mapping program. Do not create a mapping program if you intend to use a map object. For information, see Appendix B, “Mapping Program,” on page 177 and Appendix C, “Templates,” on page 209.
2. Optional — Create a map object. Do not create a map object if you created a mapping program or if the values in the PSF Configuration object are sufficient to meet your needs. See “Creating a Map Object” on page 104 for instructions.
3. “QSPLJOB Authority Requirements.”
4. “Setting up Your PSF Configuration Object.”
5. “Configuring the Device” on page 64.
6. “Varying the Device ON” on page 65.
7. “Starting the Writer” on page 65.

### QSPLJOB Authority Requirements

If you are going to store the PDF file in the integrated file system, before transforming to PDF, ensure that QSPLJOB has these authorities:

- QSPLJOB must have change (\*RWX) authority to root ('/').
- If the PDF is going to be stored as a stream file, QSPLJOB needs at least execute (\*X) authority to every directory in the path. It also needs change (\*RWX) authority to the directory that will contain the PDF files (the parent directory). For example, if you want the PDF files put in directory3, which is in this path: /directory1/directory2/directory3, QSPLJOB needs \*X authority to directory1 and directory2 and \*RWX authority to directory3.

### Setting up Your PSF Configuration Object

Before you set up your PSF configuration object, you need to decide how you want the output routed. Consider these questions:

- What do you want done with the PDF file after it is created? It can be stored in a directory, placed on an output queue, sent as e-mail, or any combination of those. Control this with the PDFGEN parameter.
- Do you want the input file respooled as AFP data? Use the AFPSAVE parameter to control this.
- Does the input spooled file have routing tags? If so, do you want the input file broken into multiple output files or do you want one output PDF file with index tags? Use the PDFMULT parameter to specify this.
- Are you generating multiple files from a single input file? If so, do you want each segment processed the same way, or do you want to specify unique output options for each segment? To distribute segments in multiple ways requires a mapping program. Specify a mapping program on the PDFMAPPGM parameter.
- Do you want to specify options only available with a mapping program? Some such options are:
  - PDF file name
  - Full control over PDF file’s location in the integrated file system
  - cc, bcc, reply to e-mail addresses

- E-mail subject text
- Encryption of e-mailed PDF
- Files to include in the body of the e-mail or to attach to the e-mail
- Intelligent routing of segments; that is, doing something different with each segment

If so, specify a mapping program on the PDFMAPPGM parameter.

- Did you write a mapping program or did you create a map object to customize the transform? If you created a map object, specify it on the PDFMAP parameter and specify PDFMAPPGM(\*IBMPGM).

Create a new PSF configuration object or change an existing PSF configuration object by using CRTPSFCFG or CHGPSFCFG, respectively. You must specify something other than \*NO for PDFGEN on the PSF configuration object in order to use the PDF subsystem. The parameters that let you customize a PSF configuration object for use with the PDF subsystem are listed in “PSF Configuration Object Parameters” on page 82.

Instead of using the command line, you can create and change a PSF configuration object by using the iSeries Navigator component of iSeries Access. Refer to *iSeries Guide to Output* for instructions.

For descriptions of other parameters you can use with CRTPSFCFG and CHGPSFCFG, refer to the appropriate command description topic in the iSeries Information Center.

**Example:**

This command creates a PSF configuration object that specifies the following:

- PDF is generated and sent as e-mail, spooled to an output queue, and stored it in the integrated file system as a stream file.
- The input file is respooled as AFP.
- The PDF data is spooled to PDFQUEUE and the AFP data is spooled to AFPQUEUE.
- The PSF stream file is stored in /home/mydir.
- The map object MYOBJECT is used, along with the IBM-supplied mapping program. Therefore, the values specified on the PSF configuration object for PDFGEN, PDFOUTQ, PDFDIR, AFPSAVE, and AFPOUTQ are only used if the values are not specified in the map object.

```
CRTPSFCFG PSFCFG(MYCONFIG) PDFGEN(*SPLF *STMF *MAIL)
PDFMAPPGM(*IBMPGM) PDFMAP(MYLIB/MYOBJECT) PDFOUTQ(MYLIB/PDFQUEUE)
PDFDIR('/home/mydir') AFPSAVE(*YES) AFPOUTQ(MYLIB/AFPQUEUE)
```

## Configuring the Device

Set up your device the same way you would set up a TCP/IP IPDS printer. You can have multiple devices active, but each must be configured as a different printer with a different port. Use Create Device Description (Printer) (CRTDEVPRT) or Change Device Description (Printer) (CHGDEVPRT) to specify the following:

<b>Device description</b>	<i>device-name</i>
<b>Device class</b>	*LAN
<b>Device type</b>	*IPDS
<b>Device model</b>	0

<b>LAN attachment</b>	*IP
<b>Advanced function printing</b>	*YES
<b>Port number</b>	xxxxx, use a different number for each printer you create.
<b>Font</b>	printer-font
<b>Remote location</b>	127.0.0.1
<b>User defined object</b>	
	<b>Object</b> PSF-configuration-object-name
	<b>Library</b> PSF-configuration-object-library
	<b>Object type</b> *PSFCFG

**Example:** In this example, we configure the device named PRINTER. It is set up on port number 12345, and jobs sent to this device use font 001 by default. The PSF configuration object associated with PRINTER is MYPSFCFG. “Setting up Your PSF Configuration Object” on page 63 describes how to create an appropriate PSF configuration object.

```
CRTDEVPRT DEVD(PRINTER) DEVCLS(*LAN) TYPE(*IPDS)
MODEL(0) LANATTACH(*IP) AFP(*YES) PORT(12345) FONT(001)
RMTLOCNAME('127.0.0.1') USRDFNOBJ(MYLIB/MYPSFCFG *PSFCFG)
```

## Varying the Device ON

Enter this command to vary the device ON:

```
VRYCFG CFGOBJ(device-name) CFGTYPE(*DEV) STATUS(ON)
```

*device-name* is the name of the device created in “Configuring the Device” on page 64.

**Example:** In this example, we vary the device named PRINTER on.

```
VRYCFG CFGOBJ(PRINTER) CFGTYPE(*DEV) STATUS(ON)
```

## Starting the Writer

Enter this command to start the printer writer:

```
STRPRTWTR(device-name)
```

**Example:** In this example, we start the writer named PRINTER.

```
STRPRTWTR(PRINTER)
```

---

## Transforming a Spooled File to PDF

There are two ways to access the PDF subsystem:

- Submit the job to a printer that is set up properly. See “Configuring the Device” on page 64 for information about setting up the printer device. See “Example” on page 66 for an example.
- Use the iSeries Navigator component of iSeries Access. See “Accessing the PDF Subsystem with iSeries Access” on page 67 for instructions.

You use the PSF configuration object associated with the printer to specify what is done with the PDF file, whether AFP is spooled, and other transform options. For information about PSF configuration object parameters you can use to customize the PDF transform, see “PSF Configuration Object Parameters” on page 82.

You can customize the PDF transform even more by using a mapping program. There are two ways to work with a mapping program:

- Create a map object and use it to specify values to the IBM-supplied mapping program. See Chapter 5, “Map Objects,” on page 103 for more information.
- Write your own mapping program. See Appendix B, “Mapping Program,” on page 177 for the format and Appendix C, “Templates,” on page 209 for an example.

Use the PDFMAP and PDFMAP parameters on the PSF configuration object to specify the mapping program and map object as appropriate.

## Example

This example shows how to convert the spooled file MY\_FILE to PDF and send it as e-mail.

1. Set up the i5/OS as a POP server. This lets us use our local i5/OS as an SMTP server to send the e-mail. For instructions, refer to “Setting up POP e-mail clients” in the iSeries Information Center. From the Information Center go to Networking → TCP/IP → E-Mail → Send and Receive E-mail on iSeries → Set up POP e-mail clients.
2. Create a user profile and give it an SMTP user ID and SMTP domain.
  - This command creates a user ID called ME in the System Distribution Directory. The user’s address is ADDRESS and the user works on the system SYSTEM. The description is “My user profile”.

```
ADDIRE USRID(ME ADDRESS) SYSNAME(SYSTEM) USRD(My user profile)
```
  - Because we are using an SMTP mail server to send e-mail, ME needs to have an SMTP address. Enter this command to add the SMTP address ME@BUSINESS.COM:

```
CHGDIRE USRID(ME ADDRESS) USRDFNFLD((SMTPAUSRID SMTP 'ME')
(SMTPDMN SMTP 'BUSINESS.COM'))
```

Alternatively, you can follow these steps to add the SMTP address ME@BUSINESS.COM:
    - a. Enter this command: `WRKDIRE USRID(ME ADDRESS)`
    - b. Specify option 2 “Change” in the Opt field next to ME.
    - c. Press F19, “Change name for SMTP”.
    - d. Press Enter when prompted at the bottom of the screen.
    - e. Enter the SMTP User ID (ME) and Domain (BUSINESS.COM) on the appropriate lines.
3. Create a PSF configuration object. In this example, the PSF configuration object is called EMAILS. It specifies that the local i5/OS is used to send the e-mail and that the user ME is the e-mail sender.

```
CRTPSFCFG PSFCFG(EMAILS) PDFGEN(*MAIL) PDFMAILSVR(*LOCAL) PDFSENDER(ME)
```
4. Configure the device. This command creates a new device description called MAIL. Note that EMAILS is the PSF configuration object we created to convert an input file to PDF and e-mail it.

```
CRTDEVPRT DEV(DMAIL) DEVCLS(*LAN) TYPE(*IPDS) MODEL(0) LANATTACH(*IP) AFP(*YES)
PORT(12345) RMTLOCNAME('127.0.0.1') USRDFNOBJ(EMAILS *PSFCFG) FONT(11)
```
5. Vary the device ON:

```
VRYCFG CFGOBJ(DMAIL) CFGTYPE(*DEV) STATUS(ON)
```
6. Start the writer:

```
STRPRTWTR(DMAIL)
```



7. Specify the address to which the e-mail is sent. This e-mail is to be sent to JOE@IBM.COM. There are many ways to specify the e-mail address. For more information about specifying an e-mail address, see Chapter 6, “Sending E-mail,” on page 149. In this example, we put the e-mail address in the spooled file attributes. Our spooled file is named MYFILE and was created by job JOBNAM with job number 123456, which was run under USER’s user profile:
 

```
CHGSPLFA FILE(MYFILE) JOB(123456/USER/JOBNAM) USRDFNDA('mailto:joe@ibm.com')
```
8. Release the spooled file MYFILE to the MAIL writer.

## Accessing the PDF Subsystem with iSeries Access

You can use iSeries Navigator to access the PDF subsystem. To do this, you need AFP Manager and Infoprint Server for iSeries 5.2 or higher installed. *iSeries Guide to Output* has instructions to install AFP Manager.

### Before You Begin

- Make sure that you have a PSF configuration object that tells PSF/400 to transform the spooled file into a PDF file.
 

Use one of these methods to create a new PSF configuration object or modify an existing one:

  - Use AFP Manager. Refer to *iSeries Guide to Output* for instructions. On the **PDF Destinations** page, select **Generate PDF** and any of the PDF distributions you want. For help on any field, select the field and press F1.
  - Run the command Create PSF Configuration (CRTPSFCFG) or Change PSF Configuration (CHGPSFCFG) from iSeries Navigator. Specify a value other than \*NO for Generate PDF (PDFGEN). You can specify other appropriate values as described in “Setting up Your PSF Configuration Object” on page 63. Refer to *iSeries Guide to Output* for instructions to run an i5/OS command from iSeries Navigator.
  - Run the command Create PSF Configuration (CRTPSFCFG) or Change PSF Configuration (CHGPSFCFG) from the i5/OS command line. Specify a value other than \*NO for Generate PDF (PDFGEN). You can specify other appropriate values as described in “Setting up Your PSF Configuration Object” on page 63.
- Make sure that the writer that processes the spooled files is configured properly. To configure a writer to transform a spooled file to PDF, run the command Create Device Description, Printer (CRTDEVPRT) or Change Device Description, Printer (CHGDEVPRT). Specify the values listed in “Configuring the Device” on page 64. You can run commands from iSeries Navigator or the i5/OS command line. Refer to *iSeries Guide to Output* for instructions to run an i5/OS command from iSeries Navigator.

**Note:** Do not change the User data field on the input spooled file. AFP Manager uses this field to communicate with PSF.

### Steps to Convert a Spooled File to PDF

Follow these steps for “ad hoc” access to the PDF subsystem, instead of accessing it through a batch process.

1. In iSeries Navigator, expand **My Connections** (or your active environment).
2. Expand **Basic Operations** and select **Printer Output**.
3. Right-click the output files you want to convert. To select more than one file, CTRL+click each file. Select **Convert to PDF...** . The **Convert Printer Output to PDF** dialog opens with the specified printer output files listed in **Printer output to convert**.

4. Select **Send as electronic mail**, **Save in Integrated File System**, or **Save to output queue** along with any other values you want, such as a mapping program.
5. Specify the device to use to convert the printer output file. You can specify library-qualified output queue, the printer to send the output file to, or both.
6. Click **OK**.

A new printer output file is created for each printer output file you selected. When the file is processed, the new output files are removed from the output queue. For help with any field, select the field and press **F1**.

**Note:** Do not change the User data field on the input spooled file.

---

## How Do I...

“Transforming a Spooled File to PDF” on page 65 lists the general steps to transform a spooled file to PDF. Here are some additional tasks you might want to perform to customize your PDF output:

- “Include Images that are Not in a Page Segment”
- “Specify Intelligent Routing” on page 69
- “Respool a Spooled File as AFP” on page 70
- “Specify a PDF Administrator” on page 71
- “Specify Encryption and Password Protection for a PDF File” on page 72
- “Set the Public Authority Level for a PDF File” on page 73
- “Specify the Public Authority to the PDF Directory” on page 74
- “Name a PDF File and Specify its Location” on page 75
- “Insert Routing Tags into the Data” on page 76
- Create a map object - see “Creating a Map Object” on page 104

### Include Images that are Not in a Page Segment

The PDF transform now supports *object containers*. An object container is an “envelope” that can contain non-AFP data objects, such as GIF images. Use the DDS keyword AFPRSC to include these objects in your data. For information about using the AFPRSC keyword, refer to the “DDS Reference: Printer Files” topic in the Information Center. To find this topic from the Information Center, search for the term DDS Reference.

The PDF subsystem supports these types of objects in an object container:

- JPEG images
- GIF images
- TIFF images
- Single page PDF objects

**Important:** You must ensure that the device to which you send the data supports the type of object included.

Objects in an object container and included in a spooled file sent to the PDF subsystem must meet these guidelines:

object	acceptable types
JPEG image	all levels of compression
GIF image	all types accepted, including animated

object	acceptable types
TIFF image	<ul style="list-style-type: none"> <li>• uncompressed</li> <li>• LZW compressed</li> </ul>
Single page PDF	PDF images that result in a single page

You can also use the AFPRSC keyword to include IOCA (including FS45), GOCA, and BCOCA objects in your data. You cannot use the AFPRSC keyword to include page segments.

### Common mistakes when using the AFPRSC keyword:

These are some commonly made mistakes to avoid when using object containers:

- The IOCA, GOCA, or BCOCA object that is included with the AFPRSC keyword is actually in a page segment. PSF will produce error PQT3502 in this case.
- The GOCA object presentation space is quite large and a scaling option of position and trim is specified. The part of the GOCA object that you want might be trimmed off. The PDF subsystem does not support the scale to fill option with GOCA.
- The PDF subsystem does not support the object type included, such as an EPS image. PSF will produce error PQT2835 if a data type is encountered that is not supported by the PDF subsystem.

## Specify Intelligent Routing

Intelligent routing lets you send a spooled file to the PDF subsystem and specify that the output be distributed in any combination of the below ways. The output can be the entire file or segments of the file.

- spooled to an output queue as AFP or PDF data
- stored as a PDF stream file in the integrated file system
- sent as a PDF file attached to an e-mail

To use intelligent routing requires a mapping program. You can use the mapping program to specify everything you want done with the output files. When you use a mapping program, any values you specify in the PSF configuration object are treated as defaults. For example, assume you specified that you want an output PDF spooled file but did not specify an output queue in the mapping program. Infoprint Server tries to use the PDF output queue specified on the PSF configuration object.

**Note:** To specify a mapping program, you must specify a value other than \*NONE for PDFGEN in the PSF configuration object. However, when you specify a mapping program, the action specified for PDFGEN is overridden. The actions specified in the mapping program are used.

If your input spooled file has routing tags and you specify PDFMULTI(\*YES \*SPLIT) on the PSF configuration object, by default each output file is distributed the same way. For example, if you specified PDFGEN(\*MAIL \*STMF), by default each PDF file is e-mailed and stored as a stream file. If you do not want them all distributed the same way, use a mapping program to specify how to distribute each generated file. For information about how to do this, see Appendix B, "Mapping Program," on page 177.

## Respool a Spooled File as AFP

Along with transforming a spooled file to PDF, you might want to respool it as AFP. You could then use it for Fax, for printing on an AFP printer, or for a different use. You can respool these types of spooled files as AFP:

- SCS
- AFP Data Stream (AFPDS)
- IPDS<sup>4</sup>
- USERASCII data (that contains PostScript, PDF, or PCL). This requires Infoprint Server's Transform Manager priced feature number 5101 for PostScript and PDF or 5102 for PCL. AFP files generated by Transform Manager are image-based, not text.
- Line data<sup>5</sup>
- Mixed data<sup>5</sup>

**Note:** The job attributes from the original spooled file are usually carried through to the AFP output. However, Total copies is always 1 in the resultant AFP spooled file.

### AFP Respool Command Flow

There are several different ways to control whether the input spooled file is respooled as AFP. Understanding how the commands work will help you know how to specify respooling in your environment.

1. A file is spooled to a device that has a PSF configuration object associated with it. The PSF configuration object specifies AFPSAVE(\*YES)
2. PSF looks at the spooled file for AFPRESPOOL(\*NOPRINT) specified as user defined data. If it is, no further processing is done (including PDF generation). The AFP might be respooled, depending on the outcome of step 3.
3. PSF looks for a mapping program specified on the PSF configuration object.
  - a. If there is, PSF gets this information from the mapping program:
    - Whether to respool the input spooled file as AFP
    - To which output queue the AFP file should be spooled. If the queue is not specified on the mapping program, PSF uses the AFP output queue specified on the PSF configuration object.
  - b. If there is not, PSF looks for AFPRESPOOL on the input spooled file's User defined data. If it is there, PSF gets this information from the PSF configuration object:
    - Whether to respool the input spooled file as AFP
    - To which output queue the AFP file should be spooled

To specify that a spooled file is to be respooled as AFP data, do these steps as necessary:

1. (Required) Activate AFP respool on the virtual printer. To do this, specify AFPSAVE(\*YES) on the PSF configuration object associated with the printer.

**Important:** If you specify respooling for a job that is sent to a printer that does not have respooling activated, the request to respool is ignored and no error message is issued.

This command changes a PSF configuration object named CONFIG1 in MYLIB

---

4. You cannot respool files for which IPDS pass through is performed. IPDS pass through is specified on the job's printer file.

5. In order to respool line or mixed data, you must first convert it to AFPDS. To convert data to AFPDS, use the printer file's Convert line data (CVTLINDTA) parameter or use the Create AFP Data (CRTAFPDTA) command, as appropriate.

to activate AFP respool. The AFP output will be saved on the queue AFPQUEUE, which is in the library MYLIB:

```
CHGPSFCFG PSFCFG(MYLIB/CONFIG1) AFPSAVE(*YES) AFPOUTQ(MYLIB/AFPQUEUE)
```

2. (Required if you are not using a mapping program.) Specify AFP respool as User defined data in the spooled file using one of the parameters listed below. This tells PSF whether the file is to be further processed. If you specify \*NOPRINT and send the data to a printer, including the PDF subsystem, you might get AFP output and will receive nothing else. See “AFP Respool Command Flow” on page 70 for details:

```
AFPRESPOOL(*PRINT)  
AFPRESPOOL(*NOPRINT)
```

For example, assume you have a spooled file MY\_FILE that was created by the job MY\_JOB which is run under the user profile BOB. To specify that MY\_FILE is respooled and printed when sent to a device with respooling activated, use this command:

```
CHGSPLFA FILE(MY_FILE) JOB(123456/BOB/MY_JOB) USRDFNDA('AFPRESPOOL(*PRINT)')
```

**Important:** You cannot submit a print request that specifies AFPRESPOOL to a writer that does not have respooling activated. That is, it must have AFPSAVE(\*YES) and AFPOUTQ(*library/queue*) specified on the PSF configuration object. If you do submit a print request that specifies AFPRESPOOL to such a writer, your job will be held. To print this job you must remove AFPRESPOOL from the User defined data.

3. (Optional) Specify a name for the AFP file. This requires a mapping program. If you do not specify a name, the AFP file is given the same name as the original spooled file. If multiple AFP files are saved to the output queue, the files are given the routing tag’s name. For information about specifying routing tags, see “Insert Routing Tags into the Data” on page 76.

#### Notes:

1. If IPDS pass through is performed, anything specified for AFPSAVE or AFPRESPOOL is ignored. You specify the value for IPDS pass through on the printer file’s IPDSPASTHR parameter. If the system discovers that the job will not run successfully with IPDS pass through, the value is disregarded and IPDS pass through is not performed. The spooled file is transformed to printer-specific IPDS and the job continues processing.
2. Multiple AFP files are saved to the output queue when the original spooled file meets all of these conditions:
  - It is being sent to Infoprint Server’s PDF subsystem (PDFGEN on the PSF configuration object has a value other than \*NONE).
  - The device specifies AFP respooling (AFPSAVE(\*YES) is specified on the PSF configuration object).
  - It contains routing tags and will be split into multiple output files (PDFMULT(\*YES \*SPLIT) is specified on the PSF configuration object).
  - The mapping program or map object specifies AFP respooling for multiple segments.

## Specify a PDF Administrator

The PDF administrator is a user that is notified by e-mail if some of the generated output cannot be distributed properly. If this happens, the input spooled file is held. For example, a message is sent to the administrator if the file is supposed to

be segmented, but no match for the routing tag is found. The PDF file is attached to this e-mail. Errors encountered while generating the PDF are also sent to the message queue.

This option is most useful when generating multiple output files from one spooled file. If there is an error processing one of the output files generated from the spooled file, the file in error is sent to the administrator. IBM gives the attachment a default name that includes the segment number. If no administrator is specified, processing stops when an error is encountered.

For example, assume your printer output file is to be split into 10 PDF files; all 10 are to be e-mailed. If Infoprint Server cannot find a matching routing tag for the 8th segment, the other 9 PDF files are e-mailed, the PDF administrator gets an e-mail with the 8th PDF file, and the spooled file is held. You can then manually e-mail the attached PDF file where you want it instead of reprocessing the input spooled file. If you had to reprocess the input spooled file, all of the e-mails would be sent again unless you modified the application.

**Note:** Infoprint Server does not detect errors due to incorrect e-mail addresses with correct syntax. For example, assume you specified `patt@ibm.com` to send the PDF file to but the correct address is `pat@ibm.com`. Infoprint Server tries to send the e-mail to `patt@ibm.com` and does not notify the administrator. If you specify a reply to address on the mapping program, that address is sent a message when the mail is undeliverable. If you do not specify a reply to address, the address from which the mail is sent (PDFMAILSENDER) receives these messages. For information about receiving non-delivery notifications when using SNDDST to send e-mail, see “Checking for Non-delivery Messages” on page 156.

#### **Before you begin:**

In order to specify a PDF administrator, you must have your iSeries set up to send e-mail. If the PDF administrator’s e-mail address is on an iSeries, that iSeries must also be set up to receive e-mail. For instructions to set up your iSeries to send and receive e-mail, refer to the iSeries Information Center. From the Information Center, expand Networking → TCP/IP → E-mail → Configure e-mail.

#### **Specifying the PDF administrator:**

Specify the PDF administrator’s e-mail address on the PSF configuration object’s PDFADMIN parameter, where `name@domain` is the PDF administrator’s e-mail address. The address can be up to 80 characters long:

```
PDFADMIN(name@domain)
```

## **Specify Encryption and Password Protection for a PDF File**

If you use the PDF subsystem to e-mail sensitive documents as PDF, the PDF file should be encrypted, password protected, or both. If you specify any encryption options, you must specify a user password, a master password, or both. You can specify these PDF standard encryption and accessibility options in a mapping program or map object:

#### **PDF master password**

password required to change security settings

#### **PDF user password**

password required to open the document

**Encryption level**

40- and 128-bit available

**Print options**

whether the user can print, and, if 128-bit encryption is specified, what type of output a user can print

**Document change options**

whether the user can change the document and what types of changes a user can make

**Copy authority**

whether the user can copy or extract text and graphics

**Changing comments**

whether the user can add or change annotations

**Document assembly**

whether users can move pages and create bookmarks and thumbnails. This option is only available with 128-bit encryption.

**Content accessibility**

whether content accessibility is enabled. This option is only available with 128-bit encryption. With 40-bit encryption, accessibility is controlled by the Copy authority option.

If you want to specify encryption, you must have the US encryption (feature number 5722AC3) i5/OS feature installed. This is a free feature in the base operating system. To determine whether you have this feature installed, enter GO LICPGM then specify option 10, Display installed licensed programs. Look for this line:

```
5722AC3 *INSTALLED Crypto Access Provider 128-bit for AS/400
```

If it is not installed, enter GO LICPGM then specify option 11, Install licensed programs. Install program number 5722AC3.

Specify encryption options for your PDF file in a map object using the Encryption level parameter. See Chapter 5, "Map Objects," on page 103 for more information.

Alternatively, you can specify encryption in your mapping program. Use the "PDF Encryption Format" on page 195 and the Length of PDF encryption information and the Offset to PDF encryption information fields in the "Extension Area Format" on page 185.

## Set the Public Authority Level for a PDF File

When you transform a spooled file to PDF and store it in the integrated file system, you can specify the public authority to the PDF file. That is, you can specify the authority you want to give to users that meet all of these criteria:

- They do not have specific authority to the object.
- They are not on an authorization list.
- Their group profile has no specific authority to the object.

Use the "Extension Area Format" on page 185 in your mapping program to specify the public authority. You can choose one of these authority levels for the PDF file:

**\*ALL** PSF specifies \*RWX for the Public data authority and \*ALL for the Public object authorities.

**\*EXCLUDE**

Users do not have any of the data authorities to the object.

**\*RWX** Users have object operational authority and all the data authorities. This lets them change the object and perform basic functions on it. With this authority level, users can perform all operations on the object except those limited to the owner or controlled by object existence, object management, object alter, and object reference authorities.

**\*RX** Users can perform basic operations on the object, such as display its contents. The user cannot change the object. This provides object operational authority and read and execute authorities.

**\*RW** Users can view and change the object. This provides object operational authority and data read, add, update, and delete authorities.

**\*WX** Users can change the contents of an object and run a program or search a library or directory. This authority level provides object operational authority and data add, update, delete, and execute authorities.

**\*R** Users can view the contents of the object. This provides object operation and data read authorities.

**\*W** Users can change the contents of the object. This level of authority provides object operation authority and data add, update, and delete authorities.

**\*X** Users can run a program or search a library or directory. This level of authority provides object operation and data execute authorities.

## Specify the Public Authority to the PDF Directory

You can specify the public data authority for any directories that PSF creates when a mapping program specifies that PDF files are to be written to the integrated file system. The ability applies to user-written mapping programs as well as map objects.

**Requirement:** To use this function, install the PTFs for APAR SE19236 on a V5R2 or later-level server.

To specify the public data authority for these directories, specify the PSF defined option PDFDTAAUT on a PSF configuration object. For example, PSDFNOPT(PDFDTAAUT(\*RWX)).

The valid values for PDFDTAAUT are:

**\*INDIR**

The authority for the directory to be created is determined by the directory it is to be created in. The directory immediately preceding the new directory determines the authority. A directory created in the "root" (/), QOpenSys, or user-defined file system is assigned the same public, private and primary group authority, authorization list, and primary group as the directory it is to be created in. A directory created in QDLS for a folder defaults to \*EXCLUDE for a first level folder. If created in the second level or greater, the authority of the previous level is used. The QOpenSys and "root" (/) file systems use the parent directory's Data Authority value. If the value \*INDIR is specified, then PSF specifies the value \*INDIR for the \*PUBLIC object authority.

**\*RWX** The user can change the object and perform basic functions on the object except those limited to the owner or controlled by object existence



(\*OBJEXIST), object management (\*OBJMGT), object alter (\*OBJALTER) and object reference (\*OBJREF) authorities. Read, write, execute (\*RWX) authority provides object operational (\*OBJOPR) and all data authorities.

- \*RW** The user can view and change the contents of an object. Read, write (\*RW) authority provides \*OBJOPR and data read (\*READ), add (\*ADD), update (\*UPD) and delete (\*DLT) authorities.
- \*RX** The user can perform basic operations on the object, such as run a program or display the contents of a file. The user is prevented from changing the object. Read, execute (\*RX) authority provides \*OBJOPR and data \*READ and execute (\*EXECUTE) authorities.
- \*WX** The user can change the contents of an object and run a program or search a library or directory. Write, execute (\*WX) authority provides \*OBJOPR and data \*ADD, \*UPD, \*DLT, and \*EXECUTE authorities.
- \*R** The user can view the contents of an object. Read (\*R) authority provides \*OBJOPR and data \*READ authorities.
- \*W** The user can change the contents of an object. Write (\*W) authority provides \*OBJOPR and data \*ADD, \*UPD, and \*DLT authorities.
- \*X** The user can run a program or search a library or directory. Execute (\*X) authority provides \*OBJOPR and data \*EXECUTE authorities.
- \*EXCLUDE**  
The user cannot access the object. The OBJAUT value must be \*NONE, if this special value is used.

The value \*NONE is not supported for PDDTAAUT.

If you specify a value for PDDTAAUT that is not supported, PSF issues PQT0038 with reason code 5 and terminates.

#### Message PQT0038

Printer writer *writer* ended because of an error.

#### Reason code 5

Value not recognized.

## Name a PDF File and Specify its Location

If you do not specify a name for the PDF file, PSF automatically generates a file name like this: 103036\_000013\_QPDCDVV\_07172002\_000001.PDF. Also, if you do not specify the path for the PDF stream file, the PDF file is put in a location such as this: */folder-name/job-name/job-number/job-user-name/file-number/spooled-file-name/date/sequence-number/* Now, you can use a mapping program to give your PDF output a meaningful name and store it where you specify.

When using a mapping program without a map object and sending the PDF file as e-mail, use these fields to name your PDF output file:

- **Offset to file name for e-mailed PDF attachment** in the “Extension Area Format” on page 185.
- **Length of file name for e-mailed PDF attachment** in the “Extension Area Format” on page 185.

When using a mapping program without a map object and spooling the PDF file, use the **Spooled file name** field in the “Spooled File PDF Distribution Format” on page 193 to name your PDF output file.

When using a mapping program without a map object and storing the PDF file as a stream file in the integrated file system, use these fields to specify a fully-qualified path and file name:

- **Offset to PDF stream file path and file name** in the “Extension Area Format” on page 185.
- **Length of PDF stream file path and file name** in the “Extension Area Format” on page 185.

For example, if you specify `/home/user/myfile.pdf`, the path and file name override the default path and file name.

When naming your PDF file, you must adhere to the standard i5/OS naming guidelines:

- The name cannot be longer than 256 characters.
- The first character must be one of: 'A'-'Z', '\$', '#', '@'
- All other characters must be in the following group: 'A'-'Z', '0'-'9', '\$', '#', '@', '.', '-', '\_'
- The name cannot contain spaces.

Infoprint Server will not add a file extension. If you want one, you must add it yourself. IBM recommends you use a lowercase file name to ensure compatibility with other operating systems.

## Insert Routing Tags into the Data

Inserting routing tags into the data lets you generate multiple output files, each containing a routing tag, from a single input spooled file. Alternatively, you can use the routing tags to insert index tags into one output PDF file. If you choose to specify groups, all of the data must be inside a group. This section describes how to use these tools to insert routing tags into your data:

- DDS keywords
- Infoprint Server’s Create AFP Data command

The values specified for PDFMULT on the PSF configuration object determines how the PDF subsystem uses the routing tags. If you specify PDFMULT(\*NO), routing tags are ignored. Otherwise, if you specify not to split the spooled file at group boundaries, Infoprint Server will insert index tags into the output PDF file. If you specify to split the spooled file at group boundaries, Infoprint Server can generate an AFP file, a PDF file, or both from each group. In this case, the routing tags are used to identify segments for intelligent routing. This lets you specify different routing options for each segment.

When using a mapping program with a spooled file that has routing tags, use the Routing Tag field of the input data structure. Put whatever you want in the 255-byte routing tag. Then create logic in your exit program that matches the routing tag to the distribution method and details you want.

You can also add a routing tag to the file after it has been spooled. For information, see “Inserting a Routing Tag in the Input File” on page 155.

## Using DDS to Insert Routing Tags

For DDS print applications, you can put a routing tag on the DDS STRPAGGRP keyword. The STRPAGGRP keyword lets you specify up to 250 characters for the group name. This name is used as the routing tag or index tag, as appropriate. The group name can be hard coded into the DDS. However, it is more likely that it

would be passed as a variable using program-to-system fields. Program-to-system fields are defined by entering a P in position 38 of the DDS specification for the field. The program would supply the value, which in turn would be used as a parameter for the STRPAGGRP keyword.

For each STRPAGGRP keyword, there must be a corresponding ENDPAGGRP keyword. The DOCIDXTAG keyword is not used for routing tags. Figure 15 shows how to specify the STRPAGGRP and ENDPAGGRP keywords. See “Example” on page 78 for a complete example.

**Note:** This is not an example of an actual DDS application. In an actual application, there would be an ENDPAGGRP for each STRPAGGRP. Also, you would not typically mix page groups that contain a valid e-mail address with those that contain keywords. Either all records will be mapped with a mapping program or none will, depending on whether you specify a mapping program in your PSF configuration object.

```

|...+...1...+...2...+...3...+...4...+...5...+...6...+...7...
A   R RECORD1
A
A   R RECORD2
A
A   STRPAGGRP('CUST68839')
A
A   STRPAGGRP('simon@ibm.com')
A
A   R RECORD3
A   GROUP          50A P
A   STRPAGGRP(&GROUP)
A   R RECORD4
A   ENDPAGGRP

```

Figure 15. Specifying STRPAGGRP and ENDPAGGRP

In the example,

**RECORD1**

Starts a group named CUST68839. If this tag was used for an e-mail application, use a mapping program to map the tag to a valid e-mail address or other routing data.

**RECORD2**

the STRPAGGRP keyword in RECORD2 contains a valid e-mail address. A mapping program is not necessary if this format is used.

**RECORD3**

Illustrates the use of a program-to-system field. The program would assign a value to the field GROUP, just as it would any other field you would normally print. The difference is that there is a P in position 38 of the specifications. This tells DDS not to print the field, but to use it as a variable in one of the other keywords. In this case, the keyword is STRPAGGRP. You might use a mapping program, depending on whether the value for GROUP was a valid e-mail address or a key to a lookup file.

**RECORD4**

Uses the ENDPAGGRP keyword to end a group that was previously started with the STRPAGGRP keyword.

**Notes:**

1. The ENDPAGGRP keyword must be issued before ending the page (with the ENDPAGE keyword, for example).
2. DEVTYPE(\*AFPDS) must be specified on the printer file.
3. If you use any STRPAGGRP and ENDPAGGRP keywords, all data must be inside a page group.

For more information about using DDS, refer to *DDS Reference*.

## Using CRTAFPDTA to Insert Routing Tags

To use CRTAFPDTA to generate groups, follow the instructions in “Indexing with CRTAFPDTA” on page 14 to index your file. The **Index tag definition** (IDXTAG) value that is specified with **Select index for group names** (IDXGRP) is the group name. For example, in “Indexing with CRTAFPDTA” on page 29, the default value for IDXGRP, \*IDXTAG1, is NAME. This means that the value in the first index tag, which is labelled NAME, is used as the routing tag or index tag.

### Example

This example illustrates how to insert routing tags into the data then tells Infoprint Server to split up the spooled file at group boundaries. In this example, we use DDS keywords to insert routing tags into the data. For an example that uses CRTAFPDTA, refer to the end-to-end example in *IBM @server iSeries Printing VI: Delivering the Output of e-business*.

1. Change your application to insert the DDS keywords STRPAGGRP and ENDPAGGRP. This is a piece of an RPG program that generates statements.

```

.
.
.
C      *INL1      IFEQ '1'                Start Customer
C      CUST#      ADD 31200      INVC# 60      Invent Invoice#
C      *INL1      MOVE CUST#      PAGGRP 6
C      *INL1      MOVE ' '        PAGGRP 6
C      *INL1      Z-ADD0          TOTDUE 92      Reset Totals/Ctrs
C      *INL1      Z-ADD0          ITMCNT 30
C      *INL1      Z-ADD0          PAGCNT 30
C      CUST#      CHAINSEEDCUST                20
C      32         CUST#      MOVE ' SAME' STNAME
C      *INL1      Z-ADDZIP          ZIPPN 90
C*
C      *INL1      MOVE CUST#      PAGGRP 6
C*
C      *INL1      WRITEINVTOP
C      *INL1      WRITEINVTOP2      STRPAGGRP
C*
C      *INL1      ENDIF
.
.
.
CL1         WRITEINVBOT                Invoice Totals
CL1         WRITEINVBOT2      ENDPAGGRP
.
.
.

```

This is the associated DDS file:

```

.
.
.
A*
A* STRPAGGRP FOR SEGMENTING
A*
A      R INVTOP2                STRPAGGRP(&PAGGRP)
A      PAGGRP                6A P
A*
.
.
.
A*
A* ENDPAGGRP

```

```

A*
A      R INVBOT2                      ENDPAGGRP
A*

```

2. Create a PSF configuration object that tells Infoprint Server to split the spooled file at group boundaries. If appropriate, specify a mapping program to map the routing tags to a valid e-mail address or other routing data. In this example, we create a PSF configuration object named SPLIT and accept defaults for all fields not directly related to this example. You can specify anything except \*NONE for Generate PDF output when you want the input spooled file split into multiple files.

```

Create PSF Configuration (CRTPSFCFG)

Type choices, press Enter.

PSF configuration . . . . . SPLIT      Name
Library . . . . . *CURLIB      Name, *CURLIB
User resource library list . . . *JOBLIBL *JOBLIBL, *CURLIB, *NONE
Device resource library list . . *DFT      Name, *DFT
      + for more values
IPDS pass through . . . . . *NO        *NO, *YES
Activate release timer . . . . . *NORDYF   *NORDYF, *IMMED...
Release timer . . . . . *NOMAX      1-1440, *NOMAX, *SEC15...
Restart timer . . . . . *IMMED      1-1440, *IMMED
APPC and TCP/IP retry count . . 15        1-99, *NOMAX
Delay between APPC retries . . . 90        0-999
Acknowledgment frequency . . . . 100      1-32767
Printer response timer . . . . . *NOMAX    5-3600, *NOMAX
Generate PDF output . . . . . *MAIL     *NONE, *SPLF, *STMF, *MAIL
      + for more values

```

You must specify \*YES for Acknowledge multiple groups and \*SPLIT for process option in order for Infoprint server to generate multiple output files from one spooled file.

```

Create PSF Configuration (CRTPSFCFG)

Type choices, press Enter.

PDF paper size drawer 1 . . . . *LETTER   *LETTER, *LEGAL...
PDF paper size drawer 2 . . . . *LETTER   *LETTER, *LEGAL...
Multiple PDF files:
  Acknowledge multiple groups . *YES      *NO, *YES
  Process option . . . . . *SPLIT      *SPLIT, *INDEX
PDF fonts inline . . . . . *YES      *YES, *NO
PDF data queue . . . . . *NONE      Name, *NONE
  Library . . . . . Name
PDF mail server name . . . . . *SNDDST

```

Our routing tags do not specify actual e-mail addresses. Therefore, we need to specify a mapping program to map the routing tags to e-mail addresses or other routing data.

```

Create PSF Configuration (CRTPSFCFG)

Type choices, press Enter.

Sender of electronic mail . . . *SPLFOWN      Name, *SPLFOWN, QSPLJOB
PDF administrator . . . . .

PDF user program . . . . . STATEMENT      Name, *NONE, *IBMPGM
Library . . . . . MYLIB      Name
PDF mapping object . . . . . *NONE      Name, *NONE
Library . . . . .      Name
PDF output queue . . . . .      Name
Library . . . . .      Name
PDF directory . . . . .

Save AFP data . . . . . *NO      *NO, *YES

```

3. If necessary, create a mapping program or a map object to use with the IBM-supplied mapping program to map the routing tags to the appropriate data. A mapping program that maps the routing tags is shown below. For instructions to create a map object, see "Creating a Map Object" on page 104.

**Sample Mapping Program**

```

H DFTNAME(EMFINDADR)
FEMEMADDR IF E          K DISK
D*
D NOTFOUND          C          'EMDEMO52P/EMNOTFOUND'
D*
D*
DINPUTDS          DS
DJOBNAM          1          26
DSPLFID          27          36
DSPLNO          37          40B 0
DMAILTAG          41          290
DEMPDFFILE          291          630
DMLSRVTYPE          631          631
DRES1          632          632
DPATHCCSID          633          636B 0
DSENDER          637          646
DUSRDTA          647          656
DJOBSYSNAM          657          664
DTIMESTAMP          665          672
DOUTQ          673          682
DOUTQLIB          683          692
D*****
DOUTDS          DS
DDISPOSTN          1          1
DCALLAGIN          2          2
DRES2          3          4
DMSGLEN          5          8B 0
D DADDRLEN          9          12B 0
DMSGTEXT          13          267
DRES3          268          268
DEXTOFF          269          272B 0
DCCSID          273          276B 0
DRES4          277          287
DADDRESS          288          542
D*
D INPUTLEN          S          9B 0
D OUTPUTLEN          S          9B 0
D OUTINFO          S          9B 0
D*****
C *ENTRY          PLIST
C          PARM          INPUTDS          692

```

```

C          PARM          INPUTLEN
C          PARM          OUTDS          542
C          PARM          OUTPUTLEN
C          PARM          OUTINFO
C*
C          EVAL          MSGLEN = 255
C          EVAL          ADDRLEN = 255
C          EVAL          OUTINFO = 542
C*
C* Check to see if the output buffer is large enough.  OUTPUTLEN
C* contains the initial length of the output buffer.  If it is not
C* large enough, return with OUTINFO set to be the length required.
C* This program will be called right back with OUTPUTLEN = OUTINFO.
C*
C          OUTINFO      IFGT      OUTPUTLEN
C                      RETURN
C                      ENDIF
C*
C* Check to see if being called for encryption.  The PDF file name
C* in the input structure will be blank, if called for encryption.
C* If you don't want to do any encryption, just set the output buffer
C* to hexadecimal zeros and return.
C*
C          EMPDFFILE    IFEQ      *BLANKS
C                      MOVE      *ALLX'00'    OUTDS
C                      RETURN
C                      ENDIF
C*
C          EVAL          MSGLEN = 255
C          EVAL          ADDRLEN = 255
C          EVAL          CCSID = 0
C          EVAL          EXTOFF = 0
C*
C          EVAL          CALLAGIN = '0'
C          EVAL          RES2 = X'0000'
C          EVAL          RES3 = X'00'
C          EVAL          RES4 = X'000000000000000000000000'
C*
C          MOVE          *BLANKS      ADDRESS
C          6            SUBST      MAILTAG      CUSTNO          6
C          CUSTNO      CHAIN      EMEMADDR
C                      IF          NOT %FOUND
C                      EXSR      Not_Found
C                      RETURN
C                      ENDIF
C*
C          MOVE          EADDR      ADDRESS
C*
C          EVAL          MSGTEXT = 'Hello from Rochester '
C                      + %TRIMR(PERSON) + ', this is your invoice '
C                      + 'for ' + %TRIMR(COMP) + '.'
C          EVAL          DISPOSTN = '1'
C*
C          RETURN
C*****
C          Not_Found    BEGSR
C*****
C          CALL          NOTFOUND
C          PARM          CUSTNO
C          PARM          EMPDFFILE
C          EVAL          DISPOSTN = '0'
C          EVAL          ADDRLEN = 0
C          ENDSR
C*

```

---

## PSF Configuration Object Parameters

You can use these parameters to customize the PDF transform part of the PDF subsystem. You must specify something other than \*NONE for PDFGEN in order to transform data to PDF. The values on the mapping program (if one is specified) override the values on the PSF configuration object. However, if the value is missing from the mapping program, the value on the PSF configuration object is used. For example, if you are spooling the PDF file and use a mapping program that does not specify an output queue, Infoprint Server uses the PSF configuration object's PDFOUTQ value, if one is specified. If one is not specified, or the value specified is not valid, the default output queue is used.

**Migration note:** On 5.2 systems, PDFADMIN, PDFMAP, AFPSAVE, and AFPOUTQ can be specified on a PSF configuration object as PSF defined options. If you restore such a PSF configuration object to a higher-level system and do not change it, the values are left as PSF defined options. You can use the PSF configuration object that way, without making any changes. However, if you restore such a PSF configuration object and then change it, any of the above values specified as PSF defined options are moved to the appropriate parameter. For example, if your PSF configuration object specifies PSDFNOPT('AFPSAVE(\*YES)' 'AFPOUTQ(MYLIB/AFPQUEUE)'), and you change that PSF configuration object on a 5.3 system, the appropriate values for AFPSAVE and AFPOUTQ are filled in.

### AFPSAVE

Specifies whether the jobs submitted to the associated writer can be respooled as AFP. You can specify AFPSAVE with any value for PDFGEN, including \*NONE. Valid values are:

**\*NO** Jobs submitted to the associated writer cannot be respooled as AFP. This is the default.

**\*YES** Jobs submitted to the associated writer can be respooled as AFP. AFP respool is controlled by the mapping program, the map object, or the AFPRESPOOL parameter on the spooled file's User defined data. For information about the AFP respool function, see "Respool a Spooled File as AFP" on page 70.

### AFPOUTQ

The library-qualified output queue on which to spool the AFP data. This is only valid and is required if AFPSAVE is \*YES. This output queue must exist when you create the PSF configuration object. PSF tries to lock the queue when it starts the PDF subsystem writer. If it cannot lock the queue, the writer ends.

If there is a mapping program specified, the value specified on the mapping program is used. However, if the mapping program specifies AFP respooling but does not specify an output queue, this AFPOUTQ value is used. If the output queue specified on the mapping program does not exist, the AFP file is spooled to QGPL/QPRINT.

### PDFADMIN

Specify the e-mail address of the PDF administrator. If there is an error in the PDF conversion, an e-mail is sent to this address, processing continues, and the original spooled file is held. If possible, the PDF file in error is attached to the e-mail. This parameter is valid if \*NONE is not specified for PDFGEN. Valid values are:



**\*NONE**

There is no PDF administrator.

*name@domain*

The PDF administrator's e-mail address.

This value is most useful when generating multiple PDF files from one spooled file. If there is an error in PDF processing, the PDF file in error is attached and sent to this address. The attachment is given the routing tag's name from the spooled file, if one exists. If not, IBM gives it a default name. For more information about the PDF administrator, see "Specify a PDF Administrator" on page 71.

**PDFDEVTYPE**

To transform a spooled file to PDF, you send the file to the PDF subsystem's virtual printer device. This parameter specifies the type of device that the PDF subsystem's virtual printer device emulates. This parameter is only valid if PDFGEN has a value other than \*NONE. Options are:

**\*IP40240**

The virtual printer device emulates an Infoprint 40 printer device at 240 dots per inch (dpi) resolution. The transform works like a TCP/IP connected 240 pel IPDS Infoprint 40 with the 4820 feature, with these exceptions:

- Object area shading and page area shading is supported.
- Bi-level color image and text, and graphic and bar code color is preserved in PDF output.
- Multiple output bins, finishing, and jogging are not supported.
- IPDS multi-resolution support is not supported.
- Multiple identical copies are not supported.
- Separator pages are not supported.
- Double-byte outline fonts are not supported. There are no resident double-byte fonts.

**\*IP40240** can use raster fonts and outline fonts.

**\*IP40300**

The virtual printer device emulates an Infoprint 40 printer device at 300 dpi resolution.

**Recommendation:** IBM recommends that you use this option whenever possible.

The transform works like a TCP/IP connected 300 pel IPDS Infoprint 40 with the 4820 feature, with these exceptions:

- Object area shading and page area shading is supported.
- Bi-level color image and text, and graphic and bar code color is preserved in PDF output.
- Multiple output bins, finishing, and jogging are not supported.
- IPDS multi-resolution support is not supported.
- Multiple identical copies are not supported.
- Separator pages are not supported.
- Double-byte outline fonts are not supported. There are no resident double-byte fonts.

**\*IP40300** can use raster and outline fonts.

- \*P4028 The virtual printer device emulates a 4028 printer device. This value is designed to be used for compatibility only and uses the raster fonts that are resident in a 4028 printer. It cannot use outline fonts.
- \*P3812 The virtual printer device emulates a 3812 printer device. This value is designed to be used for compatibility only and uses the raster fonts that are resident in a 3812 printer. It cannot use outline fonts.

## PDFDIR

Specifies the directory where the stream file will be stored. The directory must be created by the user or installation.

If the directory name specified does not already exist, it will be created for you. The directories and files created by the PDF transform are owned by the spooled file owner and have a public authority of \*EXCLUDE. This parameter is required if PDFGEN(\*STMF) is specified.

### Notes:

1. To avoid having system-generated subdirectories appended to the directories you specify, use a mapping program to specify the PDF directory and file name.
2. If you use a mapping program to specify the PDF directory, you can specify the public authority to the directories created by the PDF transform.
3. If you want to mail this file later using the Send Distribution (SNDDST) command, specify QDLS/directory-name as the directory name.
4. If an SMTP mail server is specified, you must specify a threadsafe file system. These file systems are not threadsafe:
  - QNetware
  - QFileSvr.400
  - Network File System (NFS)
  - QDLS
5. The spool writer (QSPLJOB) needs at least execute (\*X) authority to every directory in the path. It also needs change (\*RWX) authority to Root and the directory that will contain the PDF files (the parent directory). For example, if you want the PDF files put in directory3, which is in this path: /directory1/directory2/directory3, QSPLJOB needs \*X authority to directory1 and directory2 and \*RWX authority to Root and directory3. You can grant authority to the writer in one of two ways. You can either specify the appropriate authority for \*PUBLIC, or you can grant appropriate private authority to the QSPLJOB user profile.

Options are:

### *PDF-directory-name*

Specifies the directory where the stream file is stored. If there is a mapping program specified, the value specified on the mapping program is used, with no additional subdirectories. However, if the mapping program or map object specifies to store the PDF output as a stream file but does not specify a directory, this value is used.

Unless you specify the Root file system, the transform stores the PDF file in the below location. If you want to e-mail the stream file with the SNDDST command later, specify the shared folders directory (QDLS)

and the name of the folder you want the file stored in. In this case, *folder-name* below would be */QDLS/folder-name*:  
*/folder-name/job-name/job-number/job-user-name/file-number*  
*/spooled-file-name/date/sequence-number/*

The path has these values:

**folder-name**

The directory name you specified. This might be */QDLS/folder-name/*.

**job-name**

The job name assigned to the spooled file. There is an 8-character segment name limitation on QDLS path names. Therefore, the job name is left-aligned and the last two characters are stored as a prefix on the job number.

**job-number**

The job number assigned to the spooled file, prefixed by the last two characters of the job name.

**job-user-name**

The job user name assigned to the spooled file. There is an 8-character segment name limitation on QDLS path names. Therefore, the job user name is left-aligned and the last two characters are stored as a prefix on the file number.

**file-number**

The file number assigned to the spooled file, prefixed by the last two characters of the job user name.

**spooled-file-name**

The first eight characters of the spooled file name.

**date** The two-digit month appended to the two-digit day appended to the four-digit year.

**sequence-number**

The six character sequence number. It is 000001 if PDFMULT(\*NO) is specified. If PDFMULT(\*YES) is specified, the sequence number is incremented to uniquely identify each PDF file generated for a job, starting with 000001. If an error is encountered in the conversion, the sequence number of the file is prefixed with an E.

If you specify a Root File System directory name such as *PDF-directory-name*, the file will be stored in the below location. If you want to e-mail the PDF file with an SMTP server later, specify the Root file system:

*/PDF-directory-name/job-name/job-user-name*  
*/job-number\_file-number\_spooled-file-name\_date\_sequence-number*

The path has these values:

**PDF-directory-name**

The Root file system subdirectory in which you want the PDF file stored.

**job-name**

The 10-character job name assigned to the spooled file.

**job-user-name**

The 10-character user name.

**job-number\_file-number\_spooled-file-name\_date\_sequence-number**

The six-character job number, appended to the six-character file number, appended to the 10-character spooled file name, appended to the eight-character date (month-day-year), appended to a six-character sequence number (see **sequence-number** above). Each value is separated by an underscore.

**PDFDTAQ**

Specifies the name and library of the data queue where PDF logs the notifications that a transformation has been completed. This parameter is only valid if PDFGEN has a value other than \*NONE. Keyed data queues are not supported. For information about using this data queue, see “PDF Conversion Completion Data Queue” on page 95. Options are:

**\*NONE** No completion notifications are logged in a data queue.

*Library-name/PDF-data-queue*

Specifies the name of the data queue and the library it is in. PSF does not create or manage this data queue. If specified, the data queue must exist and have a minimum length of 752.

**PDFGEN**

Specifies whether the spooled file is converted to PDF. This parameter is valid only for printer devices that are configured with the loopback address and AFP(\*YES). You can specify \*NONE or any combination of \*SPLF, \*STMF, and \*MAIL. If there is a mapping program specified, the values specified on the mapping program are used instead. Options are:

**\*NONE** No PDF file is generated.

**\*SPLF** The PDF output is placed on the output queue specified in PDFOUTQ. If you specify \*SPLF and no mapping program and then try to convert a file owned by any of these profiles: QAUTPROF, QCLUMGT, QCOLSRV, QDBSHR, QDBSHRDO, QDFTOWN, QDIRSRV, QDLFM, QDOC, QDSNX, QFNC, QGATE, QLPAUTO, QLPINSTALL, QMSF, QNETSPLF, QNFSANON, QNTP, QPEX, QPM400, QRJE, QSNADS, QSPL, QSPLJOB, QSYS, QTCP, QTFTP, or QTSTRQS, the new spooled file will be owned by QSPLJOB.

When spooling the output PDF file, you can also use these parameters: PDFOUTQ (required), PDFMULT, PDFMAPPGM, and PDFMAP.

**\*STMF** The PDF output is placed into a stream file in the directory specified in the PDFDIR parameter. When storing the output PDF file as a stream file, you can also use these parameters: PDFDIR (required), PDFMULT, PDFMAPPGM, and PDFMAP.

**\*MAIL** The PDF output is electronically mailed. You can specify a value for PDFSENDER or accept the default. The PDF file is sent as an attachment. If your i5/OS is not set up to send e-mail, see “Enabling Your i5/OS to Send E-Mail” on page 150 for instructions.

For sending e-mail, you can also use these parameters: PDFMULT, PDFSENDER, PDFMAILSVR, PDFMAPPGM, and

PDFMAP. For more information about sending a PDF file as e-mail, see Chapter 6, "Sending E-mail," on page 149.

### PDFINCFNT

Specifies whether the PDF files generated by the PDF subsystem carry the necessary fonts inline.

#### \*YES

Fonts are carried inline with the PDF output. This makes the file larger, but guarantees font fidelity.

#### \*NO

Fonts are not carried inline with the PDF output. The application needs access to the fonts for printing or viewing the file.

### PDFMAILSVR

Specifies which mail server is used to e-mail the PDF output files and any messages to the PDF administrator. You can use an SMTP server or the Send Distribution (SNDDST) command. This parameter is only valid if something other than \*NONE is specified for PDFGEN is specified. If you specify an i5/OS to be your SMTP server, it must be configured as a POP server. For instructions, refer to "Setting up POP e-mail clients" in the iSeries Information Center. From the Information Center go to Networking → TCP/IP → E-Mail → Send and Receive E-mail on iSeries → Set up POP e-mail clients.

Options are:

#### \*SNDDST

The Send Distribution (SNDDST) command is used to send e-mail. If you specify \*SNDDST, you have only limited use of the mapping program. For example, you can specify encryption of the PDF file, but you cannot specify cc addresses.

#### \*LOCAL

Your local i5/OS is used as an SMTP server. It must be configured as a POP server.

#### *mail-server-name*

Specify up to four SMTP mail servers to try to use to send e-mail. You can specify \*LOCAL as one of the four. To use an i5/OS, it must be configured as a POP server.

PSF tries to use the first server listed to send the e-mail. If the first server does not work, PSF tries each remaining server in order until one works. If none of the mail servers can be used, the printer is ended or an inquiry message is issued. The action taken depends on the value specified for the Print Error Message (PRTERRMSG) parameter of the printer's device description.

### PDFMAP

Specify the library-qualified map object to use with the IBM-supplied mapping program. This parameter is only valid if a value other than \*NONE is specified for PDFGEN and if \*IBMPGM is specified for PDFMAPPGM. The specified map object must exist when you create the PSF configuration object. Valid values are:

#### \*NONE

There is no map object.

#### *Library-name/PDF-mapping-object-name*

Specify the map object to use with the IBM-supplied mapping program. If you specify this value, you must specify

PDFMAPPGM(\*IBMPGM). The specified map object must exist when you create the PSF configuration object.

### PDFMAPPGM

Specifies the library-qualified name of a user-defined mapping program. You can use a PDF mapping program to specify options such as the PDF file's name, the directory to store it in, and e-mail parameters. The specified mapping program must exist when you create the PSF configuration object.

If a mapping program is not specified and your file contains routing tags, Infoprint Server assumes that the routing tags are valid e-mail addresses (in the form *name@domain*). It will try to use the information in the routing tag to send the file.

If a mapping program is specified and there are routing tags in your file, Infoprint Server assumes that all routing tags need to be mapped.

For more information about using the mapping program, see Appendix B, "Mapping Program," on page 177. For information about the required structure of the mapping program, see Appendix C, "Templates," on page 209.

This parameter is valid if anything except \*NONE is specified for PDFGEN. Options are:

**\*NONE** There is no user program. PSF assumes that the routing tag is a valid e-mail address and tries to use the information in the routing tag to send the file.

**\*IBMPGM** Use the IBM-supplied mapping program. You must specify a map object to customize the mapping program.

*Library-name/PDF-mapping-program-name*

Specifies the name of the mapping program to use and the library it is in. The specified mapping program must exist when you create the PSF configuration object.

### PDFMULT

Specifies whether the transform splits the PDF output into multiple files at group boundaries. This parameter is only valid if PDFGEN has a value other than \*NONE. If you are using a map object that specifies segmented file = \*YES for any entry, specify \*YES \*SPLIT for this parameter. This value is ignored if Infoprint Server does not encounter any groups.

By default, all of the PDF files are processed the same way. For example, you can subdivide a customer statement run on customer statement boundaries and e-mail each customer the appropriate statement. Intelligent routing, which requires a mapping program, lets you process each segment uniquely. For example, you can have one segment respooled as AFP and sent as e-mail, store one segment in the integrated file system, and e-mail the rest. For information about creating an input file that generates multiple output files, see "Insert Routing Tags into the Data" on page 76. Options are:

**\*NO** One PDF file is created

**\*YES** Multiple PDF files are processed when applicable.

#### \*SPLIT

Multiple PDF output files are generated. If you are using a map object that specifies segmented file = \*YES for any entry, specify \*SPLIT. This value is ignored if Infoprint Server does not encounter any groups.

### **\*INDEX**

An index tag is placed at the group boundaries but only one output file is generated. If you want to view the PDF file, this option is useful for navigation.

### **PDFOUTQ**

Specifies the library-qualified name of an output queue that PSF uses when spooling the PDF output. This parameter is required when PDFGEN(\*SPLF) is specified. The owner of the original spooled file becomes the owner of the new PDF file. This output queue must exist when you create the PSF configuration object. PSF tries to lock the queue when it starts the PDF subsystem writer. If it cannot lock the queue, the writer ends.

If there is a mapping program specified, the value specified for the output queue on the mapping program is used instead of this value. If the queue on the mapping program does not exist, the output is spooled to QGPL/QPRINT. However, if the mapping program specifies PDF spooling but does not specify an output queue, this value for PDFOUTQ is used. PDFOUTQ requires this value:

*Library-name/PDF-output-queue*

Specifies the name of the output queue to use and the library it is in.

### **PDFPPRDWR1**

Specifies the paper size to use for drawer one during the transform process. This information is used as the page size in the PDF output file. The paper size is reported to PSF for the IPDS printer device and is considered the printable area.

This parameter is only valid if PDFGEN has a value other than \*NONE.

Options are:

#### **\*LETTER**

Use the dimensions of letter paper.

#### **\*LEGAL**

Use the dimensions of legal paper.

#### **\*STATEMENT**

Use the dimensions of statement paper.

#### **\*EXECUTIVE**

Use the dimensions of executive paper.

#### **\*LEDGER**

Use the dimensions of ledger paper.

**\*A5** Use the dimensions of A5 paper.

**\*A4** Use the dimensions of A4 paper.

**\*A3** Use the dimensions of A3 paper.

**\*B5** Use the dimensions of B5 paper.

**\*B4** Use the dimensions of B4 paper.

### **PDFPPRDWR2**

Specifies the paper size to use for drawer two during the transform process. This information is used as the page size in the PDF output file. The paper size is reported to PSF for the IPDS printer device and is considered the printable area.

This parameter is only valid if PDFGEN has a value other than \*NONE.  
Options are:

**\*LETTER**

Use the dimensions of letter paper.

**\*LEGAL**

Use the dimensions of legal paper.

**\*STATEMENT**

Use the dimensions of statement paper.

**\*EXECUTIVE**

Use the dimensions of executive paper.

**\*LEDGER**

Use the dimensions of ledger paper.

**\*A5** Use the dimensions of A5 paper.

**\*A4** Use the dimensions of A4 paper.

**\*A3** Use the dimensions of A3 paper.

**\*B5** Use the dimensions of B5 paper.

**\*B4** Use the dimensions of B4 paper.

**PDFSENDER**

Specifies the sender from whom e-mails are sent. This parameter is only valid if a value other than \*NONE is specified for PDFGEN. If there is a mapping program specified, the value specified for Mail sender on the mapping program is used. However, if the mapping program does not specify the mail sender, this PDFSENDER value is used.

When PSF uses a user profile to determine the e-mail sender (that is, if you specify any value other than QSPLJOB for this parameter):

- The user profile must exist on the system and must have an entry in the System Distribution Directory with a user ID specified.
- If the user profile has an SMTP user ID, that User ID is used as the sender, even if you use SNDDST to send the mail. Otherwise, if you use SNDDST to send the mail and there is no SMTP User ID, the profile's User ID is used.

For example, if user profile MY\_PROFILE has a User ID of JIM and an SMTP User ID of JIMJ, the e-mail sender is JIMJ, regardless of the mail server used. If the user profile had no SMTP User ID and you use SNDDST to send the mail, the e-mail sender is JIM.

If you are using an SMTP mail server to send the mail (that is, if you specify any value other than \*SNDDST for PDFMAILSVR), the System Distribution Directory entry for the sender must have an SMTP user ID and SMTP domain specified. For example, if the sender's e-mail address is *name@business.com*, the SMTP user ID is *name* and the SMTP domain is *business.com*.

Use Display Directory Entries (DSPDIRE) to view the entry in the System Distribution Directory. For information about working with the System Distribution Directory, see "Enabling Your i5/OS to Send E-Mail" on page 150. For instructions about specifying an SMTP address on a System Distribution Directory entry, see step 7 in "Steps to Enable Your i5/OS to Send E-mail" on page 151.



The spooled file owner is responsible for any e-mail cleanup. Options are:

- \*SPLFOWN** PSF uses the user profile for the spooled file's owner to obtain the sender.
- QSPLJOB** PSF sends the e-mail.
- Mail-file-sender* Specifies the name of a valid user profile that is used to obtain the e-mail sender.

---

## Usage Notes

There are many considerations that affect the transform and how you can use the transformed data. This section describes restrictions on the AFP input and the differences to expect between the AFP and PDF files. It also describes how to best use the PDF output. See these sections for more information:

- "Object Containers"
- "IOCA, BCOCA, and GOCA Objects"
- "Bar Codes"
- "Color" on page 92
- "Error Checking" on page 92
- "Find Function" on page 92
- "Fonts" on page 92
- "Other Unsupported IPDS Functions" on page 93
- "Output File Size" on page 93
- "Page Numbering" on page 94
- "Printing Considerations" on page 94
- "Use of Printer Features" on page 94
- "Viewing Considerations" on page 95

### Object Containers

When using object containers, you must ensure that the device to which you send the data supports the type of object included. The types of objects supported by the PDF subsystem are listed in "Include Images that are Not in a Page Segment" on page 68. You can specify at most 10 object containers per page of data.

These objects are not automatically rotated when using the PAGRTT DDS keyword or the PAGRTT parameter on the printer file. Refer to the iSeries Information Center for more information about rotation and object containers.

### IOCA, BCOCA, and GOCA Objects

The PDF transform now supports IOCA FS45 objects. You can use the image transforms described in Chapter 3, "Transforming Image Data to AFP," on page 39 to generate IOCA FS45 objects. You can use The AFPRSC keyword to include IOCA, GOCA, and BCOCA objects on the page. For information about using the AFPRSC keyword, refer to the "DDS Reference: Printer Files" topic in the Information Center. To find this topic from the Information Center, search for the term DDS Reference.

### Bar Codes

The PDF transform does not support bar code types X'1A': RM4SCC and X'1B': Japan Postal Barcode. Bar codes generated by the PDF subsystem are not guaranteed to scan correctly.

## Color

The DDS color support that was available before OS/400 V5R1 can be used with the PDF output. For DDS extended color support available with OS/400 V5R1 and higher, the RGB and CYMK color models are supported. The CIELAB and HIGHLIGHT color models are not supported. The transform supports full-color objects encoded in FS45, JPEG, GIF, and TIFF. See "Include Images that are Not in a Page Segment" on page 68 for details.

## Error Checking

The data stream error reporting in the PDF transform is not an exact emulation of the error checking by an IPDS printer. It is recommended that you print the PDF output to an actual IPDS printer before sending it as e-mail.

## Find Function

The Adobe Acrobat find function is designed to locate text strings within a document. Under certain circumstances, the find function might not work with transformed PDF files.

### AFP character encoding representation

The PDF transform uses the AFP font encoding to create the PDF document. The characters contained in the document might not be the same as the ASCII character mapping available on the keyboard used for PDF viewing.

### Character alignment

AFP text placement can use relative and absolute placement of characters within a single print line. In order to preserve the output fidelity of a document, corresponding placement of characters is performed in the PDF output document. This can result in additional "space" characters within a character string. This restricts the operation of the find function.

For best results with the Find function, search for single words.

### Graphic characters

The Find function cannot find text that has been generated using AFP GOCA output graphic characters.

## Fonts

AFP and IPDS output uses fonts that are resident on the i5/OS or are printer-resident. These fonts can be outline or raster in 240 or 300 dpi, depending on the printer emulation.

### Font substitution

When your document uses host-resident (downloadable) raster fonts, the PDF subsystem substitutes Adobe Type 3 fonts. When your document uses outline fonts or printer-resident raster fonts, the PDF subsystem substitutes Adobe Type 1 fonts. The PDF subsystem also uses Adobe Type 1 fonts if your document uses downloadable raster fonts and specify USEOUTLFNT(\*YES) in the PSF configuration object.

Because the Adobe Type 3 fonts appear blurry when viewing, IBM recommends you use outline or printer-resident fonts in your documents.

### Embedding fonts

When the IPDS document is converted to PDF, the font information is converted into PDF format and is embedded in the output document by

default. This ensures that correct character encoding is retained and increases print fidelity, but increases file size.

If you specify PDFINCFNT(\*N0) on the PSF configuration object, fonts are not embedded. You should ensure that your viewing application has access to the correct fonts before using this option.

**Raster fonts**

Only the characters required for printing are embedded in the output document. This is called *font sieving*.

**Outline fonts**

IBM recommends that you use AFP outline fonts when possible for viewing and printing quality, and portability.

**Double-byte fonts**

The PDF transform does not support any resident double-byte character sets or downloaded outline double-byte character sets. Downloaded raster double-byte coded fonts are supported.

**Fixed pitch and PSM fonts**

Some of the fixed pitch and proportional spacing machine (PSM) fonts with FGIDs below 300 are not supported in IP40240 and IP40300 mode. Applications that require these fonts might have to use 4028 or 3812 mode.

**Default font and code page**

The default font and code page are specified by the CRTDEVPRT CHRID parameter.

## Other Unsupported IPDS Functions

The following IPDS functions are not supported by the PDF subsystem:

**Media controls:**

These media controls are not supported:

- Alternate media destination
- Media source by copy
- N\_Up printing

**Mark form processing:**

The size of the Mark Form will not always be the same as in the emulated IBM printer. No relation to the actual feed direction is implemented in the Mark Form indication.

**IPDS text controls**

Partial characters are not used for the Overstrike (OVS) operation.

## Output File Size

**Maximum size**

The PDF output cannot be larger than 10 GB.

**Outline fonts**

Each outline font referenced in the input document increases the PDF file size by approximately 110 KB. If you must include fonts with your document, try to limit the number of unique outline fonts that are used.

## Page Numbering

PDF output contains a unique page number identification that is assigned during the creation of the PDF output file. This page number might not correspond to the page numbers used in the AFP input document.

The PDF output file cannot have more than 20,000 pages.

## Printing Considerations

The results of printed output may vary from the PDF document viewed using Adobe Acrobat. This is usually caused by the printer driver used.

### Adobe Acrobat

To print the PDF output from your desktop, you need Adobe Acrobat Reader 5.0 or higher. You can download it free from the Adobe Web site: <http://www.adobe.com/products/acrobat/>.

### Printing from the spool

To print the PDF output on a PDF printer, that printer must support PostScript level 3015.

### Print fidelity

The quality and appearance of your PDF output depend on the type and capabilities of the printer you use.

### Printer specific features

If your input job is designed to use specific printer features, ensure that the device that runs the transform and the transform itself supports these capabilities. The printer features that the transform does not support are described in "Use of Printer Features."

### Edge-to-edge

Print output designed for edge-to-edge printing can only be accurately reproduced by a printer that supports edge-to-edge printing.

### Printable area

The transform specifies the printable area as the entire page size.

### Image output

PDF image output might look different than the original AFP image when the PDF document is printed, depending on your printer.

## Use of Printer Features

If your original document or formatting options requires specific media options or printer features, this information is not contained in the PDF output. For example, if a form definition, a printer file, or DDS specifies duplex printing, input bins, and output bins, this information is not contained in the PDF. You can use printer driver options to select some of these options when you print the document.

### Page size

The page size used for PDF output depends on which paper drawer the input uses. The page size used by that paper drawer is specified on the PDFPPRDWR1 or PDFPPRDWR2 option in the PSF configuration object. The printable area is specified as the entire page size. The same page size is used for the whole PDF document.

### Duplex

Duplex information is not contained within the PDF document output. Thus, documents that contain a combination of simplex and duplex pages

will not retain that information. Use printer driver options to specify duplex when you print a PDF document.

#### **Number of copies**

PDF output is always produced as a single copy, regardless of DDS, printer file, or form definition specifications. Use printer driver options to specify multiple copies when you print a PDF document.

#### **Landscape**

If you request landscape output, the PDF output will be in landscape format. If you later want portrait orientation, use Adobe Acrobat or the Acrobat Viewer Plug-in to rotate the document.

## **Viewing Considerations**

In certain circumstances, the PDF document might look different than the original AFP document.

#### **Adobe Acrobat**

The PDF output generated by the PDF transform is designed to be viewed with Adobe Acrobat Reader 3.0 or later, or Adobe Acrobat Plug-in 4.0. Use with earlier versions of these products might produce unpredictable results. You must have Adobe Acrobat Reader 5.x or higher to view documents that are have 128-bit encryption.

#### **Raster fonts**

The actual appearance of raster fonts when using Adobe Acrobat Viewer or Acrobat Plug-in can differ from the printed output. For example, in the Acrobat Reader some characters might not appear to be aligned on the character baseline. The appearance might change as you choose higher magnification levels in Acrobat Reader.

The default setting of the Acrobat Reader is to show all fonts under 6 pixels as Greek, or shaded gray lines. Therefore, some of the AFP output might not be visible in Acrobat Viewer. In order to correct this problem, in the Reader click **File** and select **Preferences**. On the **General** page, ensure that **Use Greek text below xx pixels** is not selected.

#### **Image output**

PDF image output might look different than the original AFP image when the PDF document is viewed, depending on your monitor.

#### **Rotation**

The PDF output is optimized for viewing. Therefore, its pages are automatically rotated for readability. For example, pages that are supposed to print with 90 degrees clockwise rotation (typical landscape rotation), are rotated 90 degrees counter-clockwise in the PDF. Because of this, when the PDF file is printed, rotated pages might have to be manually rotated in a different direction.

---

## **PDF Conversion Completion Data Queue**

Infoprint Server provides a data queue for tracking when a PDF conversion is complete. Entries are logged in this data queue when a spooled file has been converted to PDF and Infoprint Server processing is completed. For example, if the PDF file is being stored as a stream file, the entry is logged after the PDF file is stored in the integrated file system or document library system.

You can use the data queue with or without a mapping program. A mapping program can use the Receive Data Queue API (QRCVDIAQ) to determine when a

spooled file has been converted to PDF. You might use this to trigger a secondary process. For example, once a file has been converted to PDF, post it on a Web site. Refer to the iSeries Information Center for more information about data queues and the QRCVDTAQ API.

## Using the Data Queue

If the data queue is specified properly, each time a spooled file is converted to PDF and stored in the integrated file system or document library system, an entry is sent to the queue. To use the data queue, follow these steps:

1. Use **Create data queue** (CRTDTAQ) to create the data queue with these values:
  - **Maximum message length** (MAXLEN) is 752 or higher.
  - **Sequence** (SEQ) is \*FIFO or \*LIFO.
2. Specify the name of the data queue on the PSF configuration object. To do this, use the PDFDTAQ parameter on the Create PSF configuration object (CRTPSF CFG) or Change PSF configuration object (CHGPSFCFG) command. PDFGEN must have a value other than \*NONE.

If a data queue's format is not valid and PSF tries to add entries to it, PSF sends a message to the message queue associated with the print writer and continues processing.

It is the user's responsibility to manage the data queues. This includes creating, clearing, and deleting the data queue.

## Format

Table 4 shows the format of an entry sent to the data queue when a spooled file is converted to PDF.

*Table 4. Data Queue Entry Format*

Decimal Offset	Hex Offset	Type	Description
0	0	CHAR(10)	Function
10	A	CHAR(2)	Record type
12	C	CHAR(2)	Return value
14	E	CHAR(26)	Qualified job name <b>CHAR(10)</b> Job name <b>CHAR(10)</b> User name <b>CHAR(6)</b> Job number
40	28	CHAR(10)	Spooled file name
50	32	CHAR(2)	Reserved
52	34	BINARY(4)	Spooled file number
56	38	CHAR(250)	Routing tag
306	132	CHAR(340)	Path and name of PDF file
646	286	CHAR(2)	Reserved
648	288	BINARY(4)	Path name CCSID
652	28C	CHAR(10)	Mail sender

Table 4. Data Queue Entry Format (continued)

Decimal Offset	Hex Offset	Type	Description
662	296	CHAR(10)	User data
672	2A0	CHAR(80)	Reserved

A description of each field follows:

**Function**

Identifies the record type within the function that created the data queue entry. The value for converting a spooled file to PDF is \*PDFWTR.

**Record type**

Identifies the function that created the data queue entry. Valid values are:

- 01 Spooled file conversion record

**Return value**

Identifies whether the conversion from IPDS to PDF was successful. Values are:

- 01 File was successfully converted and stored in specified folder.
- 02 File was successfully converted and stored on specified output queue.
- 03 File was successfully converted and sent as e-mail.
- 04 File was successfully converted but the mapping program specified not to mail PDF file.
- 05 File was successfully converted but was not e-mailed because the routing tag or address was not valid.
- 06 Conversion error.
- 07 Spooling to output queue failed.
- 08 Mail servers available.
- 09 Placing file in integrated file system failed.
- 10 Mail sender does not have valid entry in system distribution directory.
- 11 Error condition was set by the mapping program.
- 12 REPLYTO offset or REPLYTO length is incorrect.
- 13 Total path length specified is too large.
- 14 Use of path directory specified, but no path directory was entered.
- 15 Error was received from the mapping program.
- 16 AFP respool value is incorrect.
- 17 Public authorization is incorrect.
- 18 STMF value is incorrect.
- 19 SPLF value is incorrect.
- 20 MAIL value is incorrect.
- 21 Encryption values are incorrect.
- 99 User specified no disposition for the PDF file.

**Qualified job name**

Identifies the qualified job name of the job that created the spooled file that

was converted to PDF. The first 10 characters are the job name, the next 10 characters are the user name, and the last six characters are the job number.

**Spoiled file name**

Identifies the name of the spoiled file that was converted to PDF.

**Spoiled file number**

Identifies the unique number of the spoiled file that was converted.

**Routing tag**

Identifies the mail address or keyword. The routing tag can be specified on the printer file or spoiled file **User defined data** (USRDFNDDTA) parameter. Alternatively, it can be specified by the DDS STRPAGGRP keyword or the CRTAFFDDTA Group Name. If you specify a keyword, such as a customer number, it must be mapped to a valid e-mail address by a mapping program.

**Path and name of PDF file**

Identifies the path and name of the PDF file.

**Path name CCSID**

The CCSID of the path and PDF file name.

**Mail sender**

The name of the mail sender from **User defined data** or the PSF configuration object.

**User data**

The value in the printer file **User defined data** parameter. It contains blanks if **User defined data** contains blanks.

---

## Error Recovery

This section describes where error messages are sent, common problems and possible solutions.

If the PDF subsystem encounters an error when starting the transform, the transform returns to the program that called it. It then writes an error message to the PDF transform job log. This will happen if TCP/IP is not started, for example. PSF times out when it tries to communicate with the PDF transform and logs its own error.

If an error occurs while processing an e-mail address, the spoiled file is held and processing continues with the next ready spoiled file. This happens if the e-mail address is not in the form *name@domain* or has spaces on the end, for example. No error is detected if the address is in the correct format but is not deliverable, such as when the address is misspelled.

## Messages

All error messages except 50C8 and 50CB are sent to the appropriate job log and printer message queue as they occur. Messages 50C8 and 50CB are only sent to the job log. BATCH is the PDF subsystem job log. You can access the job logs through **job\_number/user/job\_name**. The printer message queue is specified on the CRTDEVPRT MSGQ parameter.

You can specify an address for PDF administrator (PDFADMIN) on the PSF configuration object. In this case, if an error occurs when distributing the output, an e-mail is sent to the administrator with the PDF file attached and the input



spooled file is held. For example, the PDF administrator will receive an e-mail if the PDF subsystem cannot find a match for a routing tag specified on a segment. For more information about specifying the administrator, see PDFADMIN in “PSF Configuration Object Parameters” on page 82.

If you try to e-mail the PDF file to an i5/OS and the send fails, a failure message is issued to the message queue associated with the writer. A message is also sent to the PDF administrator when one is specified. To get this message from the message queue when Send Distribution (SNDDST) sends the e-mail, the sender must use the Query Distribution (QRYDST) command with \*OUT specified on the Incoming or outgoing prompt (OPTION parameter).

If the e-mail is sent, but is not delivered, the non-delivery message is sent to the reply to address specified on the mapping program or map object. If you did not specify a reply to address, these messages are sent to the PDFSENDER specified on the PSF configuration object. If the iSeries is configured as a POP server, you can use a mail program to retrieve the messages from the iSeries. For instructions about obtaining non-delivery messages when using SNDDST to send the e-mail, see “Checking for Non-delivery Messages” on page 156. For instructions about setting up your iSeries as a POP server, refer to the topic “Setting up POP e-mail clients” in the iSeries Information Center. From the Information Center go to Networking → TCP/IP → E-Mail → Send and Receive E-mail on iSeries → Set up POP e-mail clients.

## Troubleshooting

This section describes some common errors and possible ways fix them. See also “Troubleshooting the PDF Mapping Program” on page 198.

*Table 5. Troubleshooting the PDF Subsystem*

Problem	Possible Solutions
<p>When trying to print a respooled AFP print job, the job is held.</p> <p>Error message: PRINT REQUEST WILL NOT BE RESPOOLED is issued.</p>	<p>Your print job requests that AFP respooling occur, but the writer does not support that function. Try one of these:</p> <ul style="list-style-type: none"> <li>• If you want to print the job, remove the respool request from the print request.</li> <li>• If you want AFP respooling done, activate it on the writer.</li> </ul> <p>You are trying to respool a print job as AFP, but the incoming data is not AFPDS. If the original data stream type was not AFPDS, it must be converted to AFPDS before respooling can occur. If the print request specifies IPDS pass through, remove IPDS pass through from the printer file.</p>
<p>When respooling a spooled file as PDF, the new spooled file is owned by QSPLJOB instead of my profile.</p>	<p>When using a PSF configuration object with *SPLF and no mapping program and then try to convert a file owned by any of these profiles: QAUTPROF, QCLUMGT, QCOLSRV, QDBSHR, QDBSHRDO, QDFTOWN, QDIRSRV, QDLFM, QDOC, QDSNX, QFNC, QGATE, QLPAUTO, QLPINSTALL, QMSF, QNETSPLF, QNFANON, QNTP, QPEX, QPM400, QRJE, QSNADS, QSPL, QSPLJOB, QSYS, QTCP, QTFTP, or QTSTRQS, the new spooled file will be owned by QSPLJOB.</p>

Table 5. Troubleshooting the PDF Subsystem (continued)

Problem	Possible Solutions
<p>When trying to send a job to a writer that specifies intelligent routing, the writer does not start.</p> <p>Error message: PRINTER WRITER &amp;1 ENDED BECAUSE OF AN ERROR is issued.</p>	<p>This error is caused by having an incorrect value for the PSF defined option specified in the PSF configuration object associated with the writer. The PSF defined option in error is listed in the error message. Correct the error and resubmit the job.</p>
<p>The PDF document does not print.</p>	<p>Examine the job log for error messages.</p> <p>Change the print fidelity to content fidelity in the printer file.</p> <p>Ensure you are using Adobe Acrobat Reader 5.0 or a printer that supports PostScript level 3015.</p>
<p>When I view the output, the fonts are blurry</p>	<p>Use outline or printer-resident raster fonts in your documents.</p> <p>If your document uses host-resident (downloadable) raster fonts, specify USEOUTLFNT(*YES) in the PSF configuration object.</p> <p>See on page 92 for more information.</p>
<p>The fonts look different in the PDF file.</p>	<p>Some font differences are normal. See “Printing Considerations” on page 94 or “Viewing Considerations” on page 95.</p> <p>Make sure that the default settings have not been changed. See “Default Transform Characteristics” on page 62.</p> <p>Use PDFDEVTYPE to select a different printer to emulate if font selection is not satisfactory.</p>
<p>Data is missing from the printout when the PDF is printed.</p>	<p>If the document is meant to print edge-to-edge, ensure that the printer is capable of printing edge-to-edge.</p> <p>Use the <b>shrink to fit</b> option when printing.</p>
<p>The printed output looks different from the original output.</p>	<p>Some differences are normal. See “Printing Considerations” on page 94.</p> <p>If output is not acceptable, use a different printer or printer driver.</p>
<p>The information is not rotated on the page correctly when printed.</p>	<p>The PDF subsystem optimizes the PDF output for viewing. It rotates pages counter-clockwise, while the PAGRTT parameter rotates pages clockwise. Because of this, the pages might have to be manually rotated after printing.</p>
<p>The information is presented on the wrong size of paper.</p>	<p>Use the PDF paper size drawer parameters (PDFPPRDWR1 and PDFPPRDWR2) in the PSF configuration object to specify the page size.</p>
<p>When I specify that the PDF output is to be stored in the integrated file system and transform the job, the writer ends and there is a message indicating “security violation” in the job log.</p>	<p>Make sure your file permissions are correct. See the PDFDIR parameter on page 84 for more information.</p>

Table 5. Troubleshooting the PDF Subsystem (continued)

Problem	Possible Solutions
When I specify that the PDF output is to be spooled to an output queue and transform the job, the writer ends and there is a message indicating "security violation" in the job log.	<p>When the PDF output is spooled, it is stored in this temporary directory: QDLS/PS/writer-job-number/job-name/job-number/job-user-name/file-number/spooled-file-name/mmdyyyy</p> <p>QSPLJOB needs change (*RWX) authority to the PS directory. Any directories that do not already exist will be created with the appropriate authorities.</p>
When I try to print my respooled AFP data, the job is held and does not print. This message is in the job log: "Print request will not be respooled. "	<p>You cannot submit a print request that specifies AFPRESPOOL to a writer that does not have AFPSAVE(*YES) and AFPOUTQ(library/queue) specified on the PSF configuration object's PSDFNOPT parameter.</p> <p>To print this job you must remove AFPRESPOOL from the User defined data.</p>
When I try to respool a spooled file as AFP data, the job is held and does not print. This message is in the job log: "Print request will not be respooled. "	<p>You are trying to respool a print job as AFP, but the incoming data is not AFPDS. If the original data stream type was not AFPDS, it must be converted to AFPDS before respooling can occur.</p> <p>If the print request specifies IPDS pass through, remove IPDS pass through from the printer file.</p>
When trying to send a job to a writer that specifies intelligent routing, the writer does not start. This message is in the job log: "Printer writer &1 ended because of an error."	<p>This error is caused by having an incorrect value for the PSF defined option specified in the PSF configuration object associated with the writer.</p> <p>The PSF defined option in error is listed in the error message. Correct the error and resubmit the job.</p>
When I try to print a file previously respooled as AFP, I get a message that PSF cannot find some resources.	<p>There are two ways to solve this problem:</p> <ul style="list-style-type: none"> <li>• Add the libraries where the resources reside to the Device resource library list. The Device resource library list is on the PSF configuration object associated with the device you are using to process the job.</li> <li>• Fully qualify all resources used in the job.</li> </ul>
When using the AFPRSC keyword in my data, PSF produces message PQT3502.	<p>The IOCA, GOCA, or BCOCA object that is included with the AFPRSC keyword is actually in a page segment. You cannot include a page segment with the AFPRSC keyword. Correct the error and resubmit the job.</p>
When using the AFPRSC keyword in my data, PSF produces message PQT2835.	<p>The PDF subsystem does not support the object type included, such as an EPS image. Correct the error and resubmit the job.</p>
When using the AFPRSC keyword to include a GOCA object, part of the object is cut off.	<p>A scaling option of position and trim is specified. The PDF subsystem does not support the scale to fill option with GOCA. remove the option and resubmit the job.</p>



---

## Chapter 5. Map Objects

A *map object* is an object that is used to supply values to the IBM-supplied mapping program. This chapter describes PDF map objects, how to create them, and how to use them. It consists of these sections:

- “Overview of Map Objects”
- “Creating a Map Object” on page 104
- “Using a Map Object” on page 143
- “Example” on page 144

---

### Overview of Map Objects

A map object acts as a database where the IBM-supplied mapping program will look for intelligent routing distribution rules. The rules let you map incoming print files or print file segments to the desired output method (or series of output methods). You can create a map object with i5/OS panels or with the PDF map APIs. Map objects have an object type of \*PDFMAP. For information about using the APIs, refer to the iSeries Information Center.

Each map object consists of multiple *map entries*; one for each set of routing actions you want done on a spooled file. For example, if you have these “types” of spooled files:

- spooled files that will be e-mailed
- spooled files that will be e-mailed and stored in the integrated file system
- spooled files that will be respooled as AFP data
- spooled files that are segmented

You would have at least four map entries in your map object, and possibly one to process errors; spooled files that don’t match the criteria for any of the map entries.

Each map entry (or *segment entry*, for segmented spooled files) has two parts:

- **File selection criteria:** This identifies the spooled files that should be processed in the ways specified by the map action. The map action is specified in the map entry.
- **Map action:** This specifies what Infoprint Server should do with the output file generated for the input spooled file. You can specify any combination of these:
  - E-mail a PDF file
  - Spool a PDF file
  - Spool an AFP file
  - Store a PDF file in the integrated file system

Generic values (in the form *abc\**) and \*ALL are allowed for some file selection criteria. Therefore, a spooled file might fit the selection criteria for more than one map entry. Because of this, you are required to specify a sequence number for each map entry. If a spooled file meets the selection criteria for more than one map entry, Infoprint Server will use the map entry with the lowest sequence number.

When working with an input spooled file that is segmented, you specify selection criteria for the input spooled file. Next, you specify the map actions for each

segment, based on its *routing tag*. This tag might be an e-mail address. Alternatively, it could be data such as a customer number that gets mapped to a distribution method specified in the map object. A routing tag is specified in one of these places:

- (for non-segmented spooled files) The User defined data's (USRDFNDDTA) mailtag parameter. You can specify User defined data on the printer file or add it to the spooled file after creation. To add it after creation, use the Change spooled file attributes (CHGSPLFA) command. The form of the routing tag is USRDFNDDTA('MAILTAG(*routing-tag*)').
- (for segmented spooled files) DDS Start page group (STRPAGGRP) group names.
- (for segmented spooled files) Index tags added with Infoprint Server's Create AFP data (CRTAFPDDTA) command. The routing tag is the value for Index tag definition (IDXTAG).

**Note:** If a segment has a routing tag specified on the segment boundary and there is also one specified on the spooled file's User defined data parameter, the routing tag specified as User defined data is ignored.

Once your map object is created, you specify it on your PSF configuration object along with the IBM-supplied mapping program.

---

## Creating a Map Object

This section describes how to use the i5/OS panels to create a map object. For information about using PDF map APIs to create a map object, refer to the iSeries Information Center.

In general, this is how you create a map object:

1. Use the Create PDF map (CRTPDFMAP) command to create a map object. See "Create PDF Map Command" for details.
2. Use the Work with PDF map entries (WRKPDFMAPE) command and the panels described in "Working with PDF Map Entries" on page 106 to create map entries in the map object. Alternatively, you can use the PDF map APIs to create the map entries. For information about the PDF map APIs, refer to the iSeries Information Center.

### Create PDF Map Command

Use the Create PDF Map (CRTPDFMAP) command to create an empty map object. After creating the map object, use the Work with PDF map entries (WRKPDFMAPE) command to add map entries to it. You can use these parameters when creating the map object:

**PDF map** Specify the library-qualified name of the map object to be created. You can use one of these values for the library:

**\*CURLIB**

Create the map object in the current library for the job. If no library is specified as the current library for the job, the QGPL library is used.

*library-name*

Specify the name of the library in which to create the map object.

### Text 'description'

Use one of these values:

#### **\*BLANK**

No text is specified to describe the object.

#### *'description'*

Specify up to 50 characters of text to describe the object, enclosed in apostrophes.

### Authority

Specify the public authority for the map object. This level of authority applies to anyone who meets all of these criteria:

- They do not have specific authority to the object.
- They are not on an authorization list.
- Their group profile has no specific authority to the object.

Specify one of these values:

#### **\*LIBCRTAUT**

The system determines the authority for the object. It uses the value specified on the Create authority prompt (CRTAUT parameter) on the Create Library command (CRTLIB) for the library containing the object to be created. If the value specified on the Create authority prompt (CRTAUT parameter) is changed, the new value will not affect any existing objects. This is the default.

#### **\*CHANGE**

Change authority allows the user to change and perform basic functions on the object. Change authority provides object operational authority and all data authorities.

**\*ALL** The user can perform all operations except those limited to the owner or controlled by authorization list management authority. The user can control the object's existence, specify the security for the object, change the object, and perform basic functions on the object. The user can change ownership of the object.

**\*USE** Use authority provides object operational authority, read authority, and execute authority.

#### **\*EXCLUDE**

Users cannot access the object.

#### *authorization-list*

Specify the name of an authorization list to be used for authority to the object. Users included in the authorization list are granted authority to the object as specified in the list. The authorization list must exist when the object is created.

## Example of Creating a Map Object

This command creates a map object named MY\_MAP:

```
CRTPDFMAP PDFMAP(MYLIB/MY_MAP) TEXT('Map object for invoicing applications')
```

Alternatively, you can fill in these values on the display:

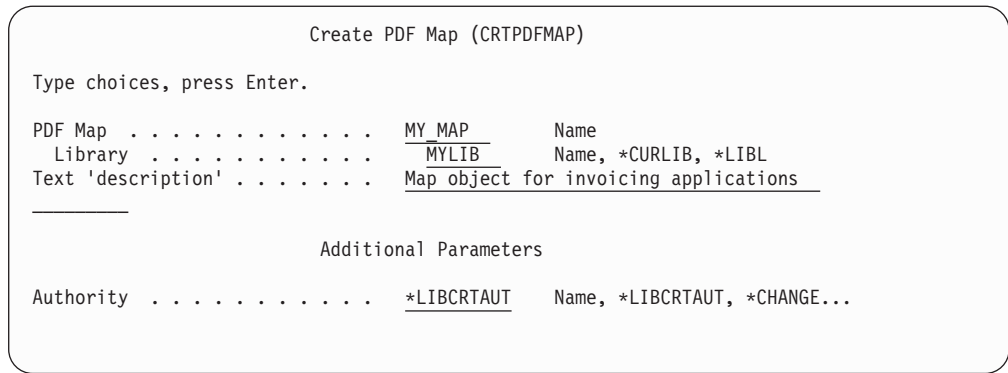

Figure 16. Creating a PDF Map Object

## Working with PDF Map Entries

After creating your map object, use the Work with PDF map entries (WRKPDFMAPE) command to customize it. This lets you tell Infoprint Server what to do with spooled files once they are transformed. This is a menu-driven command, which means that you use panels to specify values. The panels are described in this section. Figure 17 on page 107 shows the Work with PDF map entries (WRKPDFMAPE) command flow. The options available on each panel are described in detail later in this section. For an example of using the command, see “Example of adding a PDF Map Entry” on page 139.

### Segmented = \*YES or \*NO

The first thing you have to specify when creating a map entry is the value for Segmented. Despite the term “segmented”, you can use segmented and non-segmented spooled files in both categories. The value for Segmented actually specifies whether the spooled files processed as specified in the map entry are further qualified based on their routing tag values. The spooled files might or might not actually be segmented.

If you specify \*YES for Segmented file and a non-segmented file meets the spooled file selection criteria and has a routing tag that matches a routing tag specified in a segment entry, that spooled file is processed in the way specified by that segment entry.

If you specify \*NO for Segmented file and a segmented file meets the spooled file selection criteria, any segments that have routing tags that match the routing tag selection criteria are processed in the way specified by that mapping entry. If there are segments for which no match is found, they are in error. See “Error Situations” on page 148 to determine what Infoprint Server does as a result.



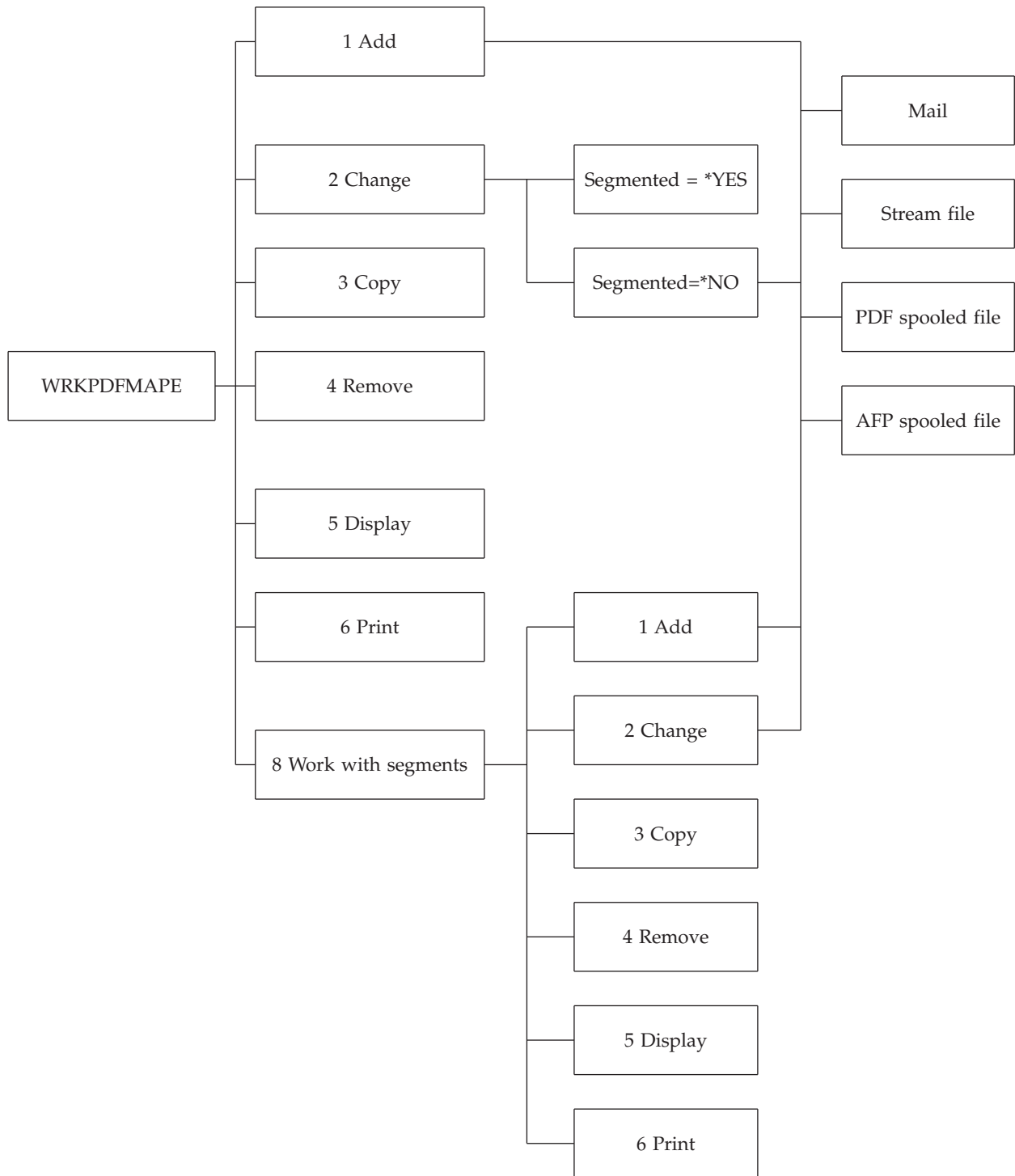

Figure 17. Work with PDF Map Entries Command Flow

### Work with PDF Map Entries Command

When you enter the Work with PDF map entries (WRKPDFMAPE) command on the i5/OS command line, a panel like the one shown in Figure 18 on page 108

opens. It shows the *PDF mapping table*, along with options to work with entries in the table. The PDF mapping table is the list of all the PDF map entries in the map object. Our sample panel shows a map object that contains two map entries.

From this panel you can add, change, copy, remove, display, or print a map entry. From here you can also specify how Infoprint Server should handle each segment in your spooled file (work with segments), if applicable.

```

Work with PDF Map Entries
PDF Map . . . : CUST_DATA          Position to . . _____
Library . . . : MAPS

Type options, press Enter.
1=Add  2=Change  3=Copy  4=Remove  5=Display  6=Print
8=Work with segments

Sequence
Opt  Number      Segmented  Text
--  -
_   1000          *NO       Sales report for Denver
_   2000          *YES      Sales report for Chicago

```

Figure 18. Work PDF Map Entry Command Display

The panel has these fields, listed below in alphabetical order:

**Library**

Specifies the library in which the map object is stored.

**Opt**

Specify the number of the option you want and press Enter. You can specify options next to more than one entry; the tasks are processed in the same order in which they are displayed.

To add a new map entry, enter option 1 in the appropriate space by the first entry field, shown by blank lines. To do anything else, enter the appropriate option by the map entry. You can specify these options:

**1=Add**

Specify this to add a new entry to the PDF mapping table. You can only use this option on the first entry field, shown as blank lines. Enter the sequence number for the new entry and whether it is segmented, then press enter.

**2=Change**

Specify this to change options in the entry, such as e-mail information or where the PDF file should be stored in the integrated file system. When you specify Change for a segmented entry, you can only change the input selection criteria (spooled file attributes). To change a segment in a segmented entry, specify 8, Work with segments, on this panel. You can then specify Change by the appropriate segment.

**3=Copy**

Specify this to copy an entry in the PDF mapping table. This lets you create a new map entry based on a similar one. You cannot copy a segmented entry, but you can copy individual segments within a segmented entry. To copy a segment entry, specify 8, Work with segments, on this panel. You can then specify Copy by the appropriate segment.

**4=Remove**

Specify this to remove the entry from the PDF mapping table. You are asked to confirm your choice before the entry is actually removed.

**5=Display**

Specify this to view the entry's details. To display a segment entry, specify 8, Work with segments, on this panel. You can then specify Display by the appropriate segment.

**6=Print**

Specify this to print the entry's details. To print a segment entry, specify 8, Work with segments, on this panel. You can then specify Print by the appropriate segment.

**8=Work with segments**

Specify this to work with segments in a spooled file.

**PDF Map**

Specifies the map object's name.

**Position to**

Helps you find a specific sequence number. To use this field, specify the sequence number of the entry you want to work with and press Enter. The entries are listed numerically, starting at the sequence number entered. If the sequence number you entered does not exist, the list is positioned to the number closest to, and in front of, the position where the number would have appeared.

**Segmented file**

Specifies whether the spooled files processed as specified in this map entry are further qualified based on their routing tag values. The spooled files might or might not actually be segmented.

If you specify \*YES for Segmented file, a non-segmented file is processed in the way specified by a segment entry when these conditions are all met:

- The file meets the spooled file selection criteria.
- The file has a routing tag that matches a routing tag specified in a segment entry.

If your spooled file is actually segmented, you must specify PDFMULT(\*YES \*SPLIT) in the PSF configuration object to have PSF split the spooled file into multiple segments. Infoprint Server can then process each of these segments according to appropriate entries in the map object.

If you specify \*NO for Segmented file, segments of a spooled file are processed in the way specified by the map entry under these conditions:

- The segmented file meets the spooled file selection criteria.
- Segments have routing tags that match the routing tag selection criteria.
- If there are segments for which no match is found, they are in error. See "Error Situations" on page 148 to determine what Infoprint Server does as a result.

**Sequence**

Specifies the map entry's sequence number. Infoprint Server uses this number to determine the order in which the entries are searched for a match. For example, if you process a spooled file with this map object and the spooled file meets the selection criteria for PDF map entries 200 and 500, it is processed in the manner specified by entry 200.

**Text** Describes the map entry. When adding a map entry, you can optionally specify a description of the entry.

### Option 1 - Add PDF Map Entry

Use option 1 to add a new map entry. Creating multiple PDF map entries lets you use one map object to process different spooled files in different ways. Adding a map entry involves two main steps:

1. Specify the spooled file selection criteria. This tells Infoprint server which map entry to use to process each spooled file. This is the panel that lists all of the selection criteria:

```

Add PDF map entry
Segmented entry . . . . . : *NO
Sequence number . . . . . 50
Text . . . . . _____

Type choices, press Enter.

Output queue . . . . . *ALL      Name, Generic*, *ALL
Library . . . . .                Name
Spooled file . . . . . *ALL      Name, Generic*, *ALL
Job name . . . . . *ALL         Name, Generic*, *ALL
User . . . . . *ALL            Name, Generic*, *ALL
User data . . . . . *ALL       Character value, *ALL
Form type . . . . . *ALL       Character value, *ALL
Routing tag . . . . . *ALL

Character value, *ALL

```

Most of the spooled file selection criteria choices are the same whether the entry is for a segmented file or not. Routing tag is not available when Segmented = \*YES. For information about specifying the routing tag selection criteria for segmented files, see “Option 8 - Work with segments” on page 120. For segmented spooled files, the routing tag is used to identify segments within the file.

See Table 6 on page 112 for a description of the parameters you can specify.

2. Specify mapping actions for the map entry. The mapping action specifies what is done with the output file. It can be sent as e-mail, stored as a stream file in the integrated file system, spooled to an output queue as PDF, spooled to an output queue as AFP, or any combination of those. If you specified PDFMULT(\*YES \*SPLIT) on your PSF configuration object, the PDF will be split into multiple files. You can then specify that each generated output file is processed in any combination of the previously mentioned ways.

Specify the mapping actions on the second panel of the command (Define PDF map action for spooled file) and the following panels. The Define PDF map action panel is shown below:

```
Define PDF map action for spooled file
Sequence number . . . . . : 50
Segmented entry . . . . . : *NO
Text . . . . . :

Type options, press Enter.

PDF map actions:
Mail . . . . . *NO *YES, *NO
PDF spooled file . . . *NO *YES, *NO
AFP spooled file . . . *NO *YES, *NO
Stream file . . . . . *NO *YES, *NO
```

Figure 19. Define PDF Map Action Panel

You can use these parameters to customize the map entry:

Table 6. Add PDF Map Entry Parameters

Parameter	Description	Panel of command	See...
<b>Information about the map entry:</b>			
Segmented file	Whether the spooled file will be segmented into multiple files	Add PDF map entry	page 114
Sequence	The entry's sequence number	Add PDF map entry	page 115
Text	The entry's description	Add PDF map entry	page 116
<b>Spooled file selection criteria:</b>			
Form type	The form type specified on the spooled file	Add PDF map entry	page 112
Job name	The job that created the spooled file	Add PDF map entry	page 113
Output queue	The output queue to which the writer that processed the job was started	Add PDF map entry	page 113
Routing tag	The routing tag specified on the spooled file	Add PDF map entry	page 114
Spooled file	The spooled file's name	Add PDF map entry	page 115
User	The user who generated the spooled file	Add PDF map entry	page 116
User data	The user data specified on the spooled file	Add PDF map entry	page 116
<b>What to do with the output files:</b>			
PDF mapping action	What to do with the resultant PDF file	Define PDF map action for spooled file	page 113
AFP spooled file = *YES	The input file should be respooled to an output queue as AFP data.	Define AFP spooled file entry	page 126
Mail = *YES	The PDF file should be sent as e-mail.	Define mail entry	page 127
PDF spooled file = *YES	The PDF file should be spooled to an output queue.	Define PDF spooled file entry	page 135
Stream file = *YES	The PDF file should be stored as a stream file in the integrated file system.	Define PDF stream file entry	page 136

A detailed description of each parameter for Add or Change PDF map entry follows. The parameters are listed below in alphabetical order.

**Form type** Specify the form type on the spooled file to process. The form type is specified on the CRTPRPF, CHGPRPF, or OVRPRPF commands' FORMTYPE parameter. This parameter is used to determine which spooled files to process as specified in this map entry.

These are the valid values:

**\*ALL** Spooled files with anything for FORMTYPE are considered a match. This value must be entered in all uppercase letters. This is the default.

*Form-type*

Specify the form type. Only spooled files with this form type are considered a match.

**Job name** Specify the job that created the spooled file to process. This parameter is used to determine which spooled files are processed as specified in this map entry.

These are the valid values:

**\*ALL** Spooled files created by any job are considered a match. This is the default.

*Generic\*-job-name*

Specify a generic job name in the form *abc\**. All spooled files created by a job name that starts with the specified value are considered a match.

*Job-name*

Specify the job that created the spooled file. Only spooled files created by this job are considered a match.

**Output queue** Specify the library-qualified output queue to which the writer that processed the job was started. This parameter is used to determine which spooled files are processed as specified in this map entry.

These are the valid values:

**\*ALL** All output queues are considered a match. This is the default.

*Generic\*-output-queue*

Specify a generic output queue name in the form *abc\**. All output queues with a name that starts with the specified value are considered a match. For example, if you specify *mail\**, the output queue *mails* is considered a match, but the output queue *email* is not.

*Output-queue*

Specify the name of an output queue. Only an output queue with this name is considered a match.

### PDF mapping action

Specify how to process the output file. You can specify that the output file is processed in any combination of these: e-mail it as a PDF file, spool it as a PDF file, spool it as an AFP file, and store it as a PDF stream file:

#### AFP spooled file

Specifies whether the input spooled file is written to a spool as AFP data.

**\*YES** Respool the input spooled file as AFP data. You can use parameters in this map entry to specify the output queue on which to write the AFP data, name the spooled file, and more. For information about these parameters, see “PDF Map Action, AFP Spooled File = \*YES” on page 126.

**\*NO** The input spooled file is not written to a spool as AFP data.

**Mail** Specifies whether the PDF file is sent as e-mail to one or more recipients. Valid values are:

**\*YES** E-mail the PDF file to one or more recipients. You can use parameters in this map entry to specify the

subject text, to, cc, and bcc addresses, encryption options, the PDF file's name, and more. For information about these parameters, see "PDF Map Action, Mail = \*YES" on page 127.

**Note:** If there is an error in any e-mail address (to, cc, bcc, or reply-to), no e-mails are sent. See "Error Situations" on page 148 for information about how errors are handled.

**\*NO** The PDF file is not sent as e-mail.

#### **PDF spooled file**

Specifies whether the PDF file is to be written to a spool as PDF data.

**\*YES** Spool the PDF file to an output queue. You can use parameters in this map entry to specify the output queue on which to spool the PDF data, the spooled file's name, and more. For information about these parameters, see "PDF Map Action, PDF Spooled File = \*YES" on page 135.

**\*NO** The PDF file is not written to a spool.

#### **Stream file**

Specifies whether the PDF file is stored as a stream file in the integrated file system.

**\*YES** Store the PDF file as a stream file in the integrated file system. You can use parameters in this map entry to specify the PDF file's name, the path where the file will be stored, and more. For information about these parameters, see "PDF Map Action, Stream File = \*YES" on page 136.

**\*NO** The PDF file is not stored as a stream file.

**Routing tag** Specify the routing tag on the incoming spooled file that should be processed in the methods specified in this map entry. This tag might be an e-mail address or it could be data such as a customer number that gets mapped to a distribution method specified in the map object. The routing tag on the spooled file is specified on the User defined data's (USRDFNDDTA) MAILTAG parameter. This parameter is used to determine which spooled files to process as specified in this map entry.

These are the valid values:

**\*ALL** Spooled files with anything for MAILTAG are considered a match. This value must be specified in all uppercase letters. This is the default.

#### *Routing-tag*

Specify the routing tag. Only spooled files with this exact routing tag are considered a match. This value is case-sensitive.

#### **Segmented file**

Specify whether the spooled files processed as specified in this



map entry are segmented. When a spooled file is segmented, it is split at group boundaries and one PDF file is generated for each group.

These are the valid values:

**\*YES** The spooled file is segmented. Add segment entries to specify how you want the segments processed.

If you specify \*YES, a non-segmented file is processed in the way specified by a segment entry under these conditions:

- The file meets the spooled file selection criteria.
- The file has a routing tag that matches a routing tag specified in a segment entry.

**Note:** You must also specify PDFMULT(\*YES \*SPLIT) on the PSF configuration object that uses this map object. Otherwise this value for Segmented file is ignored.

**\*NO** The input spooled file is not segmented. The actions you specify for the mapping action apply to the whole spooled file.

If you specify \*NO, segments of a spooled file are processed in the way specified by the map entry under these conditions:

- The segmented file meets the spooled file selection criteria.
- Segments have routing tags that match the routing tag selection criteria.
- If there are segments for which no match is found, they are in error. See “Error Situations” on page 148 to determine what Infoprint Server does as a result.

**Sequence** Specify the map entry’s sequence number. The sequence number determines the order in which Infoprint Server searches for a match for the spooled file. For example, if the spooled file meets the criteria for entries with sequence numbers 100 and 200, Infoprint Server uses the mapping action specified in map entry 100.

**Spooled File** Specify the name of the spooled file to process. This parameter is used to determine which spooled files to process as specified in this map entry.

These are the valid values:

**\*ALL** A spooled file with any name is considered a match. This is the default.

*Generic\*-spooled-file*

Specify a generic spooled file name in the form *abc\**. All spooled files with a name that starts with the specified value are considered a match. For example, if you specify *region\**, the spooled file *region1* is considered a match, but the spooled file *den\_region* is not.

### *Spooled-file*

Specify the name of a spooled file. Only a spooled file with this name is considered a match.

**Text** Specify the description of this map entry.

**User** Specify the name of the user who generated the spooled file to process. This parameter is used to determine which spooled files to process as specified in this map entry.

These are the valid values:

**\*ALL** Spooled files generated by any user are considered a match. This is the default.

### *Generic\*-user*

Specify a generic user name in the form *abc\**. All spooled files generated by a user with a name that starts with the specified value are considered a match.

*User* Specify the name of a user. Only spooled files generated by this user are considered a match.

**User data** Specify the user data on the spooled file to process. User data is specified on the CRTPRPF, CHGPRPF, or OVRPRPF commands' USRDTA parameter. This parameter is used to determine which spooled files to process as specified in this map entry.

These are the valid values:

**\*ALL** Spooled files with anything for USRDTA are considered a match. This is the default.

### *User-data*

Specify the user data. Only spooled files with this user data are considered a match.

## **Option 2 - Change PDF Map Entry**

Use this option to change a map entry. When you specify this option for a nonsegmented file, the entry is displayed with its current values and you can change any underlined value. When you specify this option for a segmented file, you can change only the file selection criteria. To change any of the segment entries, use option 8 Work with segments. These are the entries shown on the Change PDF Map Entry panel:

Table 7. Change PDF Map Entry Parameters

Parameter	Description	Panel of command	See...
<b>General information about the map entry</b>			
Segmented file <sup>2</sup>	Whether the spooled file should be segmented into multiple files	Change PDF map entry	page 114
Sequence <sup>1</sup>	The entry's sequence number	Change PDF map entry	page 115
Text	The entry's description	Change PDF map entry	page 116
<b>Spooled file selection criteria</b>			
Form type	The form type specified on the spooled file	Change PDF map entry	page 112
Job name	The job that created the spooled file	Change PDF map entry	page 113
Output queue	The output queue to which the writer that processed the job was started	Change PDF map entry	page 113
Routing tag	The routing tag specified on the spooled file	Change PDF map entry	page 114

Table 7. Change PDF Map Entry Parameters (continued)

Parameter	Description	Panel of command	See...
Spooled file	The spooled file's name	Change PDF map entry	page 115
User	The user who generated the spooled file	Change PDF map entry	page 116
User data	The user data specified on the spooled file	Change PDF map entry	page 116
<b>What to do with the output files<sup>1</sup>:</b>			
PDF mapping action	What to do with the resultant PDF or AFP file	Change PDF map action for spooled file	page 113
AFP spooled file = *YES	The input file should be respooled to an output queue as AFP data.	Change AFP spooled file entry	page 126
Mail = *YES	The PDF file should be sent as e-mail.	Change mail entry	page 127
PDF spooled file = *YES	The PDF file should be spooled to an output queue.	Change PDF spooled file entry	page 135
Stream file = *YES	The PDF file should be stored as a stream file in the integrated file system.	Change PDF stream file entry	page 136
1: For non-segmented entries only. 2: Display only. You cannot change this value.			

For example, this panel opens when you specify to change a non-segmented PDF map entry. Note that the value for Segmented entry is not underlined. Thus, you cannot change that value:

```

Change PDF map entry
Segmented entry . . . . . : *NO
Sequence number . . . . . : 100
Text . . . . . : _____

Type choices, press Enter.

Output queue . . . . . : *ALL          Name, Generic*, *ALL
Library . . . . . : _____        Name
Spooled file . . . . . : *ALL          Name, Generic*, *ALL
Job name . . . . . : *ALL             Name, Generic*, *ALL
User . . . . . : OPER*               Name, Generic*, *ALL
User data . . . . . : *ALL           Name, Generic*, *ALL
Form type . . . . . : *ALL           Character value, *ALL
Routing tag . . . . . : *ALL

Character value, *ALL
    
```

Figure 20. Change PDF Map Entry - First Panel

### Option 3 - Copy PDF Map Entry

If you want to create a map entry similar to one you already have, use this option to copy the entry. When you copy the entry, you must identify the copy with a new sequence number. You can then use Option 2 - Change to tailor the copy to your needs. You cannot copy a segmented entry. However, you can copy an entry within a segmented entry. To copy a segment, use Option 8; Work with segments. You can specify these parameters when you copy a map entry:

**New Text** Specify the description of the new map entry.

**To Sequence number**

Specify the sequence number for the new map entry. The sequence number determines the order in which Infoprint Server searches

for a match for the spooled file. For example, if the input spooled file meets the criteria for entries with sequence numbers 100 and 200, Infoprint Server will use the mapping action specified in map entry 100.

#### Option 4- Remove PDF Map Entry

When you specify that a map entry should be removed, you are asked to confirm the removal. To remove the selection, press Enter. If you do not want to remove the selection, press F12.

#### Option 5 - Display PDF Map Entry

When you specify to display a map entry, a display like the one in Figure 21 opens that shows all of the values specified in the entry. You cannot change anything when displaying the values. For information about each parameter and value shown, see the parameters listed in “Option 1 - Add PDF Map Entry” on page 110.

```
PDF Map Information
PDF Map . . . : MY_MAP           Sequence
Library . . . : MYLIB          number . . . : 100

Spooled file . . . . . : *ALL
Output queue . . . . . : *ALL
Library . . . . . :
Job name . . . . . : *ALL
User . . . . . : OPER*
User data . . . . . : *ALL
Form type . . . . . : *ALL
Routing tag . . . . . : *ALL

Text . . . . . :
Segmented entry . . . . . : *NO

Press Enter to continue.

F3=Exit  F6=Print entry  F10=Print data  F12=Cancel  More...
```

Figure 21. Display PDF Map Entry, First Panel

```
PDF Map Information
PDF Map . . . : MY_MAP          Sequence
Library . . . : MYLIB          number . . . : 100

PDF map actions:
Mail . . . . . : *YES
PDF spooled file . . . : *NO
AFP spooled file . . . : *YES
PDF stream file . . . : *NO

Press Enter to continue.

Bottom

F3=Exit  F6=Print entry  F10=Print data  F12=Cancel
```

Figure 22. Display PDF Map Entry - Second Panel

If you press F6, you print the entire entry. This is the same result as you get when you use option 6, Print PDF map entry. If you press F10, you print the information in the section of the entry shown. For example, if you press F10 on either panel above, the printout will show the values in the first two panels of the display. Note that the second panel says Bottom instead of More... at the bottom. This shows you that you are at the end of a section.

**Option 6 - Print PDF Map Entry**

When you print the map entry, a spooled file named DSPPDFMAPE is generated with the name of the map object as the user data. This spooled file is placed on the default output queue associated with the current job. When you print this spooled file, the output is formatted like the panels shown when you use option 5 to display the entry.

## Option 8 - Work with segments

These panels display when you select Option 8 or when you specify \*YES for Segmented on the Add or Change map entry panel. Use these panels to specify what Infoprint Server does with the segments in the spooled file. When the appropriate values are specified in the PSF configuration object, each segment in the spooled file is transformed into a PDF or AFP output file.

**Note:** To use a map entry to break a spooled file with groups into multiple segments, you must specify both of these:

- PDFMULT(\*YES \*SPLIT) on the PSF configuration object
- Segmented = \*YES on the map entry

Adding a segment for a map entry is much like adding a map entry for a spooled file. It involves these main processes:

1. If you have not already done so, tell Infoprint Server how to select the input spooled file that the segments are part of.
2. Tell Infoprint Server how to select a segment. To do this, you specify a routing tag. The routing tag specified must match the routing tag on the input segment. It is specified on the DDS keyword STRPAGGRP or Infoprint Server's CRTAFPDTA command with the IDXTAG parameter. If there is also a routing tag specified on the spooled file as User defined data, it is ignored.
3. Tell Infoprint Server what to do with each segment. You specify a mapping action for each segment, just as you do for the map entry. With segments, you cannot set up a completely generic segment error entry as you can with map entries. There must be a segment entry set up for each segment that will be processed.

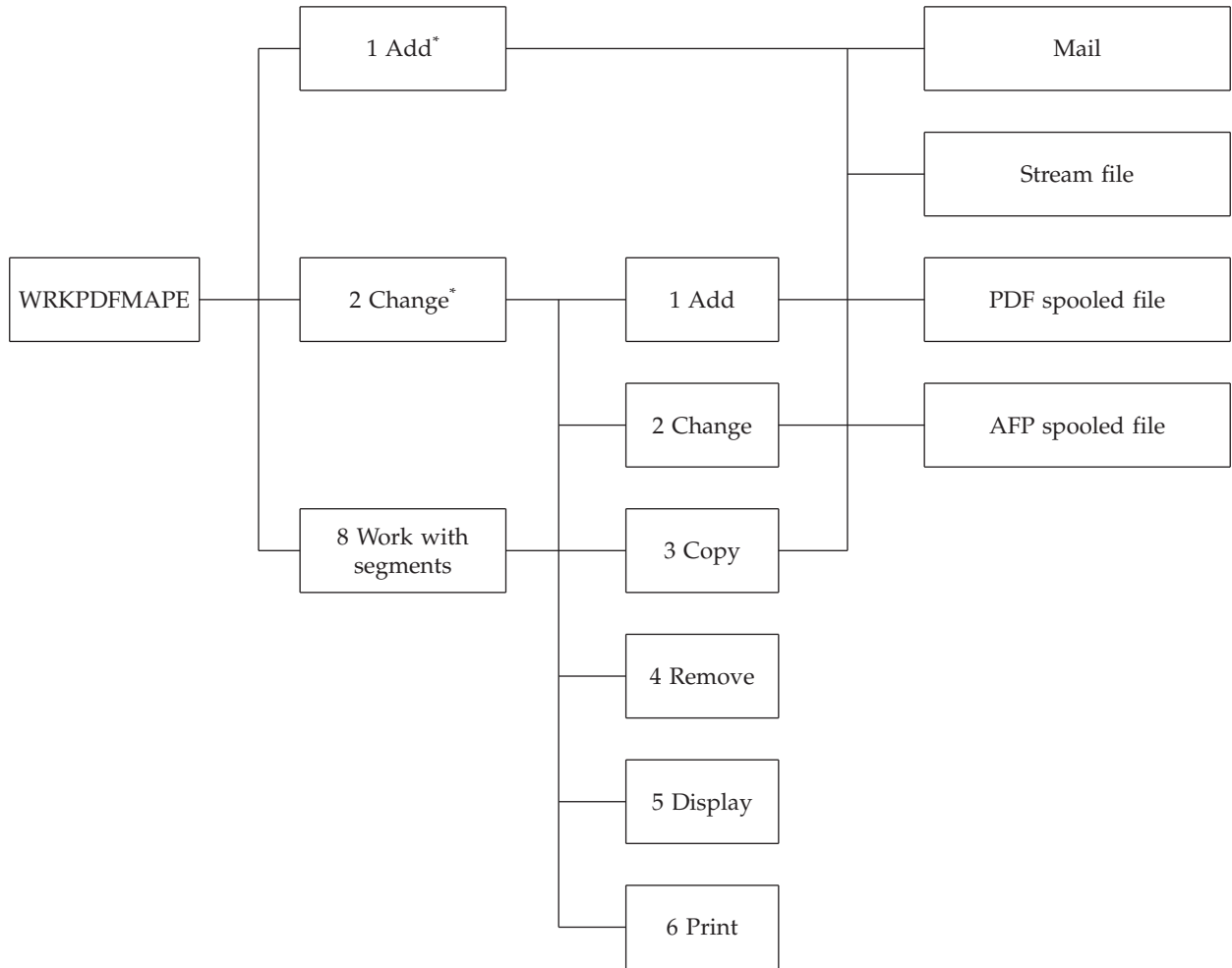

\*Segmented = \*YES

Figure 23. Work with Segments Command Flow

### Option 1 - Add segment Entry

Use option 1 to add a new segment entry. You must have a segment entry for every segment in the file. Adding a segment entry involves two main steps:

1. Specify the segment selection criteria; the routing tag. This is the panel that opens when you specify to add a segment entry. We will add a segment entry for the routing tag "CUST1009":

```

Work with PDF Map Segmented Entries
Sequence                               Job name . . . : *ALL
  number . . . : 200                    User . . . . . : *ALL
Spooled file : *ALL                     User data . . . : *ALL
Output queue : *ALL                     Form type . . . : *ALL
Library . . . :
Position to . . : _____

Type options, press Enter.
  1=Add  2=Change  3=Copy  4=Remove  5=Display  6=Print

Opt Routing tag
  1  CUST1009
_____

(No segments in entry)

```

Figure 24. Add Segment Entry - Panel 1, Routing Tag

- Specify mapping actions for the segment entry. The mapping action specifies what is done with the output file. It can be sent as a PDF attachment to an e-mail, stored as a PDF stream file in the integrated file system, spooled to an output queue as PDF, spooled to an output queue as AFP, or any combination of those. You specify the map action on the Add Segment Entry panel and on the panels that open based on your specified actions. This is the Add Segment Entry panel:

```

Add Segment Entry
Type choices, press Enter.
Routing tag . . . . . CUST1009
_____
_____
_____
_____
PDF map actions:
Mail . . . . . *NO          *YES, *NO
PDF spooled file . . . *NO    *YES, *NO
AFP spooled file . . . *NO    *YES, *NO
Stream file . . . . . *NO    *YES, *NO

```

Figure 25. Add Segment Entry Panel

These are the parameters on the Add segment entry page:

**PDF mapping action**

Specify how Infoprint Server should process this segment after converting it to the proper output format. You can specify any combination of these values:

**AFP spooled file**

Specifies whether the input spooled file segment is written to a spool as AFP data.

**\*YES** Spool the AFP file to an output queue. You can specify its name, the output queue on which it is placed, the spooled file’s name, and more.

You must specify AFPSAVE(\*YES) on the PSF configuration object to enable respooling. If you want the whole spooled file respooled as AFP, enable respooling in the spooled file. See “Respool a Spooled File as AFP” on page 70 for instructions.



For more information about respooling files as AFP, see "PDF Map Action, AFP Spooled File = \*YES" on page 126.

**\*NO** Do not spool the AFP file to an output queue. This is the default.

**Mail** Specifies whether the PDF file is sent as e-mail to one or more recipients. Valid values are:

**\*YES** Send the PDF file as e-mail. The e-mail address can be specified on the spooled file's User defined data parameter or you can specify addresses on this segment entry. If there are addresses specified in both locations, the PDF file is sent to all of the addresses.

You can also use parameters in this segment entry to specify the subject text, a message to put in the body of the e-mail, cc and bcc addresses, encryption options, a reply-to e-mail address, the PDF file's name, and more. For information about these parameters, see "PDF Map Action, Mail = \*YES" on page 127.

**\*NO** Do not send the PDF file as e-mail. This is the default.

#### **PDF spooled file**

Specifies whether the PDF file is to be written to an output queue.

**\*YES** Spool the PDF file to an output queue. You can use parameters in this segment entry to specify the output queue to which the PDF data should be written, the spooled file's name, and more. For information about these parameters, see "PDF Map Action, PDF Spooled File = \*YES" on page 135.

**\*NO** Do not spool the PDF file to an output queue. This is the default.

#### **Stream file**

Specifies whether the PDF file is stored as a stream file in the integrated file system.

**\*YES** Store the PDF file as a stream file in the integrated file system. You can use parameters in this segment entry to specify the PDF file's name, the path where the file will be stored, and more. For information about these parameters, see "PDF Map Action, Stream File = \*YES" on page 136.

**\*NO** Do not store the PDF file in the integrated file system. This is the default.

#### **Routing tag**

Specify the routing tag for the new segment. The routing tag must match the routing tag in the segment, specified on the DDS keyword Start page group (STRPAGGRP) or Infoprint Server's CRTAFPDTA command with the IDXTAG parameter. If there is also a routing tag specified on the spooled file as User defined data, it is ignored.

**Text** Specify the description of this segment entry.

### Option 2 - Change segment Entry

Use this option to change a segment entry. When you specify this option, the entry is displayed with its current entries, but you can change any value that is underlined. For example, this panel is shown when we specify to change a segment in our example map object:

```
Change Segment Entry
Type choices, press Enter.
Routing tag . . . . . CUST1009
_____
_____
_____
PDF map actions:
Mail . . . . . *NO *YES, *NO
PDF spooled file . . . *NO *YES, *NO
AFP spooled file . . . *NO *YES, *NO
Stream file . . . . . *YES *YES, *NO
```

Figure 26. Change Segment Entry Panel

See “Option 1 - Add segment Entry” on page 121 for a description of the parameters.

### Option 3 - Copy segment Entry

If you want to create a segment entry similar to one you already have, use this option to copy the segment. When you copy the segment, you must identify the copy with a new routing tag. You can then use Option 2, Change to tailor the copy to your needs. The Copy segment entry panel is shown below:

```
Copy PDF map entry
Type choices, press Enter.
From routing tag . . . . . : CUST1009
_____
_____
_____
To routing tag . . . . .
_____
_____
_____
```

Figure 27. Copy Segment Entry Panel

You can specify this parameter when you copy a segment entry:

- | **To routing tag** Specify the routing tag for the new segment. The routing tag must
- | match the group tag’s name, specified on the DDS keyword Start
- | page group (STRPAGGRP) or Infoprint Server’s CRTAFPDTA
- | command with the IDXTAG parameter. If there is also a routing
- | tag specified on the spooled file as User defined data, it is ignored.

### Option 4- Remove segment Entry

When you specify that a segment entry should be removed, you are asked to confirm the removal. To remove the selection, press Enter. If you do not want to remove the selection, press F12.

## Option 5 - Display segment Entry

When you specify to display a segment entry, a display like the one in Figure 28 opens. It shows all of the values specified in the segment. You cannot change anything when displaying the values. For information about each parameter and value shown, see the parameters listed in “Option 1 - Add segment Entry” on page 121. The first panel shows the selection criteria for the spooled file, along with the routing tag for the segment to be processed. The rest of the panels show values specific to the specified mapping actions.

```
PDF Map . . . : MY_MAP          PDF Map Information
Library . . . : MYLIB          Sequence
                               number . . : 100

Spooled file . . . . . : REPORTS
Output queue . . . . . : *ALL
Library . . . . . :
Job name . . . . . : *ALL
User . . . . . : *ALL
User data . . . . . : *ALL
Form type . . . . . : *ALL
Routing tag . . . . . : Northwest

Text . . . . . : SALES REPORT DATA
Segmented entry . . . . : *YES

Press Enter to continue.

F3=Exit  F6=Print entry  F10=Print data  F12=Cancel  More...
```

Figure 28. Display Segment Entry - First Panel

```
PDF Map . . . : MY_MAP          PDF Map Information
Library . . . : MYLIB          Sequence
                               number . . : 100

PDF stream file:
Stream file . . . . . : /month/northwest.pdf

Public authority . . . : *EXCLUDE

Press Enter to continue.

F3=Exit  F6=Print entry  F10=Print data  F12=Cancel  Bottom
```

Figure 29. Display Segment Entry - Second Panel

If you press F6, you print the entire entry. This is the same result as you get when you use option 6, Print PDF map entry. If you press F10, you print the information in the section of the entry shown. For example, if you press F10 on the panel

above, the printout will show the values in the first two panels of the display. Note that the second panel says Bottom instead of More... at the bottom. This shows you that you are at the end of a section.

### Option 6 - Print segment Entry

When you print the segment entry, a spooled file named DSPPDFMAPE is generated with the name of the map object as the user data. This spooled file is placed on the default output queue associated with the current job. When you print this spooled file, the output is formatted like the panels shown when you use option 5 to display the segment entry.

### PDF Map Action, AFP Spooled File = \*YES

When you specify AFP spooled file = \*YES for the PDF map action, the generated AFP file is spooled to an output queue. You must specify AFPSAVE(\*YES) on the PSF configuration object to use this option. These are the parameters you can specify, listed below in alphabetical order:

**Output queue** Specify the library-qualified output queue to which the AFP file is written. These are the possible values:

#### \*PSFCFG

Write the AFP file to the output queue specified on the PSF configuration object's AFPOUTQ parameter. This is the default. If you specify \*PSFCFG and an appropriate output queue is not specified on the PSF configuration object (if no output queue is specified or if the output queue does not exist), the file is spooled to QGPL/QPRINT. If you are not doing anything else with this segment, no PDF file is generated.

#### *Output-queue-name*

Specify the output queue's name. If this output queue does not exist when you try to use this map object, the file is spooled to QGPL/QPRINT.

**Form type** Specify the form type for the AFP spooled file. These are the possible values:

\*SPLF Use the original spooled file's form type. This is the default.

#### *Form-type*

Specify the AFP spooled file's form type.

**Spooled file** Specify a name for the AFP spooled file. These are the possible values:

\*SPLF Use the original spooled file's name. This is the default.

#### *Spooled-file-name*

Specify the AFP spooled file's name.

**User Data** Specify the user data for the AFP spooled file. These are the possible values:

\*SPLF Use the original spooled file's user data. This is the default.

#### *User-data*

Specify the AFP spooled file's user data.

### User Defined Data

Specify the user defined data for the AFP spooled file. These are the possible values:

**\*SPLF** Use the original spooled file's user defined data. This value must be specified in all uppercase letters. This is the default.

*User-defined-data*

Specify the AFP spooled file's user defined data. This value is case-sensitive. If you want to print the AFP data and specified AFPRESPOOL(\*PRINT) on the spooled file's User defined data, you should specify different User defined data here.

## **PDF Map Action, Mail = \*YES**

The mail panels let you customize the e-mail; specifying the e-mail addresses, cc addresses, additional attachments, encryption options for the PDF file, and more. These are the parameters you can specify when sending the PDF file as e-mail, listed below in alphabetical order:

**Attachments** Specify the files to attach to the e-mail in addition to the PDF file. If this parameter is specified and your PSF configuration object specifies PDFMAILSVR(\*SNDDST) any spooled files that match this map entry will be held.

You can specify one of these values:

**\*NONE**

Only the PDF file being generated is attached to the e-mail. This value must be specified in all uppercase letters. This is the default.

*Attachments*

Specify up to four fully-qualified files in the integrated file system to be attached to the e-mail. The first character in the path must be a forward slash (/). The directory names in the path cannot contain these characters: \ < > " ? : \* | If you specify the PDF file being generated, it is attached again.

**Notes:**

1. You must specify a threadsafe file system. These file systems are not threadsafe:
  - QNetware
  - QFileSvr.400
  - Network File System (NFS)
  - QDLS
2. All files must be encoded in a character set (CCSID) that matches the CCSID/code page of the target system.

## **BCC e-mail address**

Specify the blind carbon copy (bcc) e-mail addresses to which the e-mail is sent. If this parameter is specified and your PSF configuration object specifies PDFMAILSVR(\*SNDDST) any spooled files that match this map entry will be held.

**Note:** If there is an error in any e-mail address (to, cc, bcc, or reply-to), no e-mails are sent. See "Error Situations" on page 148 for information about how errors are handled.

You can specify one of these values:

**\*FILE** The bcc e-mail addresses are stored in a data file in the integrated file system. When you specify **\*FILE**, you will be able to specify a value for BCC e-mail stream file.

*BCC-e-mail-address*

Specify up to 100 addresses to copy on the e-mail message. Each address can be up to 80 characters long. Press F9 to specify more than one bcc address. If you want more than 100 bcc addresses, specify them in a stream file, then specify **\*FILE** as the value for this parameter.

**BCC e-mail stream file**

Specify the name and path of a data file in the integrated file system that contains the bcc e-mail addresses. Each address must be separated by a carriage control and can be up to 80 characters long. This parameter is only available when you specify **\*FILE** for bcc e-mail address.

The data file path name can be either a simple name or a name that is qualified with the name of the directory in which the object is located. For example, you could specify either of these on this parameter:

```
/home/mine/addresses  
/QSYS.LIB/LIBRARY.LIB/MYFILE.FILE/MYMEMBER.MEMBER
```

You can specify a pattern in the last part of the path name. Use an asterisk (\*) to match any number of characters and a question mark (?) to match a single character. If the path name is qualified or contains a pattern, you must enclose it in apostrophes.

For more information about specifying path names, refer to "Object naming rules" in the "CL concepts and reference" topic in the iSeries Information Center.

**CC e-mail address**

Specify the carbon copy (cc) e-mail addresses to which the e-mail is sent. If this parameter is specified and your PSF configuration object specifies PDFMAILSVR(\*SNDDST) any spooled files that match this map entry will be held.

**Note:** If there is an error in any e-mail address (to, cc, bcc, or reply-to), no e-mails are sent. See "Error Situations" on page 148 for information about how errors are handled.

You can specify one of these values:

**\*FILE** The cc e-mail addresses are stored in a data file in the integrated file system. When you specify **\*FILE**, you will be able to specify a value for CC e-mail stream file.

*CC-e-mail-address*

Specify up to 100 addresses to copy on the e-mail message. Each address can be up to 80 characters long. Press F8 to specify more than one cc address. If you want more than 100 cc addresses, specify them in a stream file, then specify **\*FILE** as the value for this parameter.

**CC e-mail stream file**

Specify the name and library of a data file in the integrated file system that contains the cc e-mail addresses. Each address must be

separated by a carriage control and can be up to 80 characters long. This parameter is only available when you specify \*FILE for CC e-mail address.

The data file path name can be either a simple name or a name that is qualified with the name of the directory in which the object is located. For example, you could specify either of these on this parameter:

```
/home/mine/addresses  
/QSYS.LIB/LIBRARY.LIB/MYFILE.FILE/MYMEMBER.MEMBER
```

You can specify a pattern in the last part of the path name. Use an asterisk (\*) to match any number of characters and a question mark (?) to match a single character. If the path name is qualified or contains a pattern, it must be enclosed in apostrophes.

For more information about specifying path names, refer to "Object naming rules" in the "CL concepts and reference" topic in the iSeries Information Center.

### **E-mail body**

Specify the files to be used for the body of the e-mail. If a file is specified, it is opened (when possible) and placed in the body of the e-mail after the message text. If the file cannot be opened and placed in the body (such as an audio file), it is attached to the e-mail. If this parameter is specified and your PSF configuration object specifies PDFMAILSVR(\*SNDDST) any spooled files that match this map entry will be held.

You can specify one of these values:

#### **\*NONE**

No files are placed in the body of the e-mail. This value must be specified in all uppercase letters. This is the default.

#### *Files-for-body*

Up to four fully-qualified files in the integrated file system to be used for the body of the e-mail. The first character in the path must be a forward slash ( / ). The directory names in the path cannot contain these characters: \ < > " ? : \* | If you specify the PDF file being generated, it is attached again. The files are placed in the body of the e-mail in the order in which you specify them.

#### **Notes:**

1. You must specify a threadsafe file system. These file systems are not threadsafe:
  - QNetware
  - QFileSvr.400
  - Network File System (NFS)
  - QDLS
2. All files must be encoded in a character set (CCSID) that matches the CCSID/code page of the target system.

### **Encryption level**

Specifies the PDF file's encryption level.

**\*NONE**

The PDF file is not encrypted. This is the default.

**\*40RC4**

Use 40-bit RC4 encryption. This has a lower level of security and is compatible with Adobe Acrobat Reader 3.X and higher. You can also specify values for these parameters:

**Print** Specifies whether users can print the PDF file.

**\*YES** Users can print the PDF file. This is the default

**\*NO** Users cannot print the PDF file.

**Change**

Specifies whether users can change the PDF file.

**\*YES** Users can change the PDF file.

**\*NO** Users cannot change the PDF file. This prevents users from filling-in form fields and making other changes. This is the default.

**Copy** Specifies whether users can copy or extract text and graphics in the PDF file. This also specifies whether the accessibility interface is enabled.

**\*YES** Users can copy and extract text and graphics in the PDF file. The accessibility interface is enabled. This is the default.

**\*NO** Users cannot copy and extract text and graphics in the PDF file. The accessibility interface is disabled.

**Change comments**

Specifies whether users can add or change comments (annotations) or form fields in the PDF file. Values are:

**\*YES** Users can add or change comments and form fields in the PDF file.

**\*NO** Users cannot add or change comments or form fields in the PDF file. Users can fill in form fields. This is the default.

**\*128RC4**

Use 128-bit RC4 encryption. This has a higher level of security but is only compatible with Adobe Acrobat Reader 5.X and higher. You can also specify values for these parameters:

**Print** Specifies whether users can print the PDF file, and if so, at what resolution.

**\*YES** Users can print the PDF file. This is the default.

**\*NO** Users cannot print the PDF file.



### **\*IMAGE**

Users are only allowed to print at low resolution (image). This prevents the user from re-creating the PDF file with different security settings. Printing might be slower because each page is printed as a bitmapped image.

### **Change**

Specifies whether users can change the PDF file.

**\*YES** The user is allowed general editing, comment and form field authoring, and has document assembly authority. This lets the user do anything to the PDF file except extract contents and print, which are controlled by the Copy and Print parameters.

**Note:** If you specify \*YES for Change, Assemble is set to \*YES, no matter what you specify for Assemble.

**\*NO** Users cannot change the PDF file. This prevents users from filling-in form fields and making other changes. This is the default.

### **Assemble**

Specifies whether users are given document assembly authority.

**\*YES** Users have document assembly authority. They can insert, delete, and rotate pages, and create bookmarks and thumbnails.

**\*NO** Users do not have document assembly authority. This is the default.

**Note:** If you specify \*YES for Change, Assemble is set to \*YES, no matter what you specify for Assemble.

### **Change comments**

Specifies whether users can change comments (annotations) and form fields.

**\*YES** Users can add and change comments, and fill-in and sign forms.

**\*NO** Users cannot add or change comments. They cannot add or change fields but they can fill in forms. This is the default.

**Copy** Specifies whether users can copy or extract text and graphics in the PDF file.

**\*YES** Users can copy and extract text and graphics in the PDF file. This is the default.

**\*NO** Users cannot copy or extract text and graphics in the PDF file.

**Content access**

Specifies whether content accessibility for the visually impaired is enabled for the PDF file.

**\*YES** Content accessibility is enabled for the PDF file.

**\*NO** Content accessibility is not enabled for the PDF file. This is the default.

**Mail sender** Specify the name of the mail sender. You can specify one of these values:

**\*PSFCFG**

Use the mail sender specified on the PSF configuration object. This is the default.

*Mail-sender*

Specify the name of the mail sender. This sender must be a valid user profile enrolled in the System Distribution Directory.

If PDFMAILSVR(\*SNDDST) is not specified on the PSF configuration object, the entry in the System Distribution Directory must have an SMTP user ID and domain specified. For example, if the sender's e-mail address is name@business.com, the SMTP user ID is name and the SMTP domain is business.com. For information about specifying System Distribution Directory entries, refer to *Infoprint Server for iSeries: User's Guide*.

**Master password**

Specify the password needed in order to change security settings for the PDF file. When password protected, the PDF file can be opened with either the user password or master password.

If you specify any security restrictions, you must specify a user password, a master password, or both. It is best to specify a master password and, optionally, a user password. Otherwise anyone who opens the file could remove the restrictions. If you specify a master password and specify \*NONE for the user password, users can view the PDF file but cannot change the security settings.

You can specify these values:

**\*NONE**

There is no master password. This is the default.

**\*AUTO**

Specifies that a master password for the PDF file is automatically generated by the system. No one will be able to change the security settings.

*Master-password*

Specify the password needed to change the PDF file's security settings. The password can contain uppercase alphabetic characters (A-Z), lowercase alphabetic characters (a-z) or numbers 0-9.

**Message text** Specify the text to be placed in the body of the e-mail. This is the first text in the e-mail. If you specify a file in Files for body of e-mail, it is placed after this text.

**\*PSFDFT**

Use the default text from message PQT4133 in message file QPQMSGF. This value must be specified in all uppercase letters. This is the default value.

*Message-text*

Specify up to 255 characters for the message text.

**PDF file name**

Specify a name for the e-mailed PDF file. These are the possible values:

**\*PSFDFT**

Use the default name from Infoprint Server. This name is 000001.PDF for a single spooled file e-mailed by SNDDST. It is longer when sent by an SMTP server. If the PDF file is encrypted, the sequence number, such as 000001, is prepended by an X. If the spooled file is segmented, the file name is incremented for each segment. For instance, the PDF files from a spooled file with 20 segments would have names ending with 000001.PDF – 000020.PDF or X000001.PDF – X000020.PDF when e-mailed.

This value must be specified in all uppercase letters.

*PDF-file-name*

Specify the PDF file's name. If you are using SNDDST to send the e-mail, this file name cannot be longer than 11 characters total; eight characters for the file name and three characters for the extension. For example, invoices.pdf is acceptable. You must specify the .pdf file extension if you want it. IBM recommends using a lowercase file extension for compatibility with other operating systems.

**Reply to e-mail address**

Specify the address to which replies to your e-mail should be sent. If this parameter is specified and your PSF configuration object specifies PDFMAILSVR(\*SNDDST) any spooled files that match this map entry will be held.

You can specify one of these values:

**\*MAILSENDER**

Replies are sent to the e-mail address specified on the Mail Sender parameter. This value must be specified in all uppercase letters. This is the default.

*Reply-to-address*

Specify an address up to 80 characters long to which replies to the e-mail are sent.

**Subject**

Specify the text for the e-mail's subject. You can specify one of these values:

**\*PSFDFT**

Use the default subject from the first 22 characters of message PQT4133 in message file QPQMSGF plus the original spooled file's name. This value must be specified in all uppercase letters. This is the default.

*Subject* Specify up to 80 characters for the subject text.

### To e-mail address

Specify the addresses to which the e-mail should be sent. Each e-mail address can be up to 80 characters long. You can specify the addresses here, specify them in an external stream file, or they can be specified in the spooled file. If there are addresses specified on the spooled file and in the mapping program, the PDF file is sent to all of the addresses.

**Note:** If there is an error in any e-mail address (to, cc, bcc, or reply-to), no e-mails are sent. See “Error Situations” on page 148 for information about how errors are handled.

These are the possible values:

**\*FILE** The e-mail addresses are stored in a data file in the integrated file system. When you specify \*FILE, you will be able to specify a value for To e-mail stream file.

**\*SPLF** The e-mail address is specified on the spooled file. Infoprint Server uses the embedded routing tag. It might be specified as user defined data, the group name for DDS keyword Start page group, or the index tag name specified on Create AFP Data. To specify the address as user defined data, it must be in this format:  
USRDFNDDTA('mailto:(name@domain)') Only one address can be specified as User defined data.

#### *E-mail address*

Specify up to 100 e-mail addresses. Press F7 to specify more than one address. If you want to specify more than 100 addresses, specify them in an external file and specify \*FILE for this parameter.

### To e-mail stream file

Specify the name and library of a data file in the integrated file system that contains the TO e-mail addresses. Each address must be separated by a carriage control. This parameter is only available when you specify \*FILE for To e-mail address.

The data file path name can be either a simple name or a name that is qualified with the name of the directory in which the object is located. For example, you could specify either of these on this parameter:

```
/home/mine/addresses  
/QSYS.LIB/LIBRARY.LIB/MYFILE.FILE/MYMEMBER.MEMBER
```

You can specify a pattern in the last part of the path name. Use an asterisk (\*) to match any number of characters and a question mark (?) to match a single character. If the path name is qualified or contains a pattern, it must be enclosed in apostrophes.

For more information about specifying path names, refer to “Object naming rules” in the “CL concepts and reference” topic in the iSeries Information Center. You can specify these values for library:

#### **\*CURLIB**

The file that contains e-mail addresses is in the current library for the job. If no library is specified as the current library for the job, QGPL is used. This is the default.

*library* The library that contains the e-mail file.

### User password

Specify the password that the user must specify to open the PDF file. When password protected, the PDF file can be opened with either the user password or master password.

If you specify any security restrictions, you must specify a user password, a master password, or both. It is best to specify a master password and, optionally, a user password. Otherwise anyone who opens the file could remove the restrictions. If you specify a master password and specify \*NONE for the user password, users can view the PDF file but cannot change the security settings.

You can specify these values:

#### \*NONE

There is no user password. This is the default.

#### *User-password*

Specify the password needed to open the PDF file. The password can contain uppercase alphabetic characters (A-Z), lowercase alphabetic characters (a-z) or numbers 0-9.

### PDF Map Action, PDF Spooled File = \*YES

When you specify PDF spooled file = \*YES for the PDF map action, the generated PDF file is spooled to an output queue. The spooled file panels let you customize the PDF spooled file. You can name the PDF file and specify the output queue to place the spooled file on. You can also specify the user data, form type, and user defined data to associate with the spooled file. These are the parameters you can specify when spooling the PDF file, listed below in alphabetical order:

**Form type** Specify the form type for the PDF spooled file. These are the possible values:

\*SPLF Use the original spooled file's form type. This is the default.

#### *Form-type*

Specify the PDF spooled file's form type.

### PDF output queue

Specify the library-qualified output queue to which the PDF file will be written. These are the possible values:

#### \*PSFCFG

Write the PDF file to the output queue specified on the PSF configuration object's PDFOUTQ parameter. This is the default. If you specify \*PSFCFG and an appropriate output queue is not specified on the PSF configuration object, the file is spooled to QGPL/QPRINT.

#### *Output-queue-name*

Specify the output queue's name. If this output queue does not exist when you use this map object, the file is spooled to QGPL/QPRINT.

**Spooled file** Specify a name for the PDF spooled file. These are the possible values:

\*SPLF Use the original spooled file's name. This is the default.

*Spooled-file-name*

Specify the PDF spooled file's name.

When specifying the file's name, be sure to add the file extension if you want one. IBM recommends using a lowercase file extension for compatibility with other operating systems.

**User Data** Specify the user data for the PDF spooled file. These are the possible values:

**\*SPLF** Use the original spooled file's user data. This is the default.

*User-data*

Specify the PDF spooled file's user data.

**User Defined Data**

Specify the user defined data for the PDF spooled file. These are the possible values:

**\*SPLF** Use the original spooled file's user defined data. This value must be specified in all uppercase letters. This is the default.

*User-defined-data*

Specify the PDF spooled file's user defined data.

**PDF Map Action, Stream File = \*YES**

The stream file panels let you specify the name and location of the PDF stream file and what the public authority is for the file. These are the parameters you can specify, listed alphabetically:

**Authority**

Specify the public authority for the PDF stream file. This level of authority applies to anyone who meets all of these criteria:

- They do not have specific authority to the object.
- They are not on an authorization list.
- Their group profile has no specific authority to the object.

Specify one of these values:

**\*EXCLUDE**

Users cannot access the object. This is the default.

**\*RWX** Users have object operational authority and all the data authorities. This lets them change the object and perform basic functions on it. With this authority level, users can perform all operations on the object except those limited to the owner or controlled by object existence, object management, object alter, and object reference authorities.

**\*RX** Users can perform basic operations on the object, such as display its contents. The user cannot change the object. This provides object operational authority and read and execute authorities.

**\*RW** Users can view and change the object. This provides object operational authority and data read, add, update, and delete authorities.

**\*WX** Users can change the contents of the object. This authority level provides object operational authority and data add, update, delete, and execute authorities.

- \*R Users can view the contents of the object. This provides object operation and data read authorities.
- \*W Users can change the contents of the object. This level of authority provides object operation authority and data add, update, and delete authorities.
- \*X Users can run a program or search a library or directory. This level of authority provides object operation and data execute authorities.

### PDF stream file

The PDF stream file's name and the path in the integrated file system where it will be stored. Specify one of these values:

#### \*PSFCFG

Infoprint Server builds the path and file name from the value specified for PDF directory (PDFDIR) on the PSF configuration object. This value must be specified in all uppercase letters. This is the default.

The file name is generated based on characteristics of the job that generated the spooled file. If you specify a QDLS directory, the file path and name is generated as follows: /QDLS/folder-name/job-name/job-number/job-user-name/file-number/spooled-file-name/date/sequence-number

If you specify a Root File System directory name, the file path and name is generated as follows: /PDF-directory-name/job-name/job-user-name /job-number\_file-number\_spooled-file-name\_date\_sequence-number

For more details about this, refer to the PDF directory name parameter on page 84.

- \*SPLF The path is specified on the spooled file. Infoprint Server uses the embedded routing tag. The routing tag can be specified as user defined data, the group name for DDS keyword Start Page Group, or the index tag name specified on Create AFP Data. To specify the address as user defined data, it must be in this format:  
USRDFNDTA('mailto:/dir1/dir2/ ... dirn /doc.pdf')

\*SPLF must be specified in capital letters.

#### *PDF-file-name*

Specify the PDF file's name and the path in the integrated file system where it will be stored. The path and file name will be exactly as specified. No subdirectories are created, as they are if you specify \*PSFCFG. The directory names in the path cannot contain these characters: \ < > " ? : \* |

Infoprint Server will create the directories if they do not exist. These directories will be owned by the original spooled file owner and have the authority for \*PUBLIC specified in the Authority parameter.

When specifying the file's name, be sure to add the file extension if you want one. IBM recommends using a lowercase file extension for compatibility with other operating systems.

#### **Notes:**

1. If you specify a file name that already exists, Infoprint Server will replace the existing file.

2. If you specified to use an SMTP mail server, you must specify a threadsafe file system. These file systems are not threadsafe:
  - QNetware
  - QFileSvr.400
  - Network File System (NFS)
  - QDLS

### Creating a PDF Map Entry to Catch Errors

If you try to process a spooled file with a map object but it doesn't match any of the file selection criteria for any of the PDF map entries, the spooled file is not transformed to PDF and is held. To avoid having the spooled file be held, while still being notified that there is a problem, you can set up a map entry to deal with such spooled files. This section describes how to set up a map entry to specify that spooled files in error should be transformed to PDF then processed in one or both of these ways:

- Notify an administrator by e-mail that the spooled file could not be processed and attach a PDF version of the spooled file to the e-mail.
- Have the generated PDF file put in the integrated file system.

**To e-mail or store a PDF version of the spooled file in error, set up a map entry this way:**

Use these parameters and values to create the map entry. If you want the PDF file e-mailed and stored as a stream file, use Mail = \*YES and Stream file = \*YES. Otherwise, choose the appropriate value.

*Table 8. Setting up a PDF Map Entry to E-mail Errors*

Parameter	Value
Sequence	99999
Text	For processing spooled files in error
Output queue	*ALL
Spooled file	*ALL
Job name	*ALL
User	*ALL
User data	*ALL
Form type	*ALL
Routing tag	*ALL
segmented file	*NO
PDF mapping action	Mail = *YES <sup>1</sup>
	Stream file = *YES <sup>2</sup>
To e-mail address <sup>1</sup>	administrator's e-mail address in the form <i>name@domain</i>
PDF file name <sup>2</sup>	*PSFCFG
<b>Notes:</b>	
1: Specify this only if you want to e-mail the PDF file.	
2: Specify this only if you want to store the PDF file as a stream file.	



## Example of adding a PDF Map Entry

This example shows how to use the WRKPDFMAPE command to add an entry to the map object MY\_MAP in library MYLIB.

1. Enter the command WRKPDFMAPE PDFMAP(MYLIB/MY\_MAP). This panel opens:

```
Work with PDF Map Entries
PDF Map . . . : MY_MAP          Position to . . _____
Library . . . : MYLIB

Type options, press Enter.
 1=Add  2=Change  3=Copy  4=Remove  5=Display  6=Print
 8=Work with segments

      Sequence
Opt  Number      Segmented Text
--  - - - - -
(No entries in table)
```

Figure 30. Work with PDF Map Entries Panel

2. We will add a map entry with sequence number 100 that is not segmented. Fill in these values and press return:

```
Work with PDF Map Entries
PDF Map . . . : MY_MAP          Position to . . _____
Library . . . : MYLIB

Type options, press Enter.
 1=Add  2=Change  3=Copy  4=Remove  5=Display  6=Print
 8=Work with segments

      Sequence
Opt  Number      Segmented Text
 1  100          *NO
(No entries in table)
```

Figure 31. Adding a PDF Map Entry

3. On the first Add PDF Map Entry panel, specify the file selection criteria. This identifies the spooled files you want processed with this map entry. For our example, we have several operators that could generate spooled files that should be processed as specified in this map entry. They all have user names that begin with OPER, so we specify the user name as the only file selection criteria.

```

                                Add PDF map entry
Segmented entry . . . . . : *NO
Sequence number . . . . . : 100
Text . . . . . : _____

Type choices, press Enter.

Output queue . . . . . : *ALL          Name, Generic*, *ALL
Library . . . . . : _____        Name
Spooled file . . . . . : *ALL          Name, Generic*, *ALL
Job name . . . . . : *ALL             Name, Generic*, *ALL
User . . . . . : OPER*                Name, Generic*, *ALL
User data . . . . . : *ALL            Character value, *ALL
Form type . . . . . : *ALL            Character value, *ALL
Routing tag . . . . . : *ALL

_____
_____ Character value, *ALL

```

Figure 32. Specifying File Selection Criteria

- Specify what you want done with the output file. We will specify that the output file is e-mailed and that the input spooled file is respooled as AFP so we can fax the document:

```

                                Define PDF map action for spooled file
Sequence number . . . . . : 100
Segmented entry . . . . . : *NO
Text . . . . . : _____

Type options, press Enter.

PDF map actions:
Mail . . . . . : *YES                *YES, *NO
PDF spooled file . . . : *NO         *YES, *NO
AFP spooled file . . . : *YES        *YES, *NO
Stream file . . . . . : *NO          *YES, *NO

```

Figure 33. Specifying the Mapping Actions

- Next, you customize the map actions that you selected. The first panels shown are for e-mail:

```

                                Add PDF map entry
Type choices, press Enter.

To e-mail addresses . . . : marketing@ibm.com
_____ Character value, *FILE, *SPLF

Subject . . . . . : Summary report
_____
_____
_____ Character value, *PSFDFT

Message text . . . . . : Here is the field summary report for last month
_____
_____ Character value, *PSFDFT

CC e-mail addresses . . . : manager@ibm.com
_____ Character value, *FILE

```

Figure 34. Specifying E-mail Information - First Panel, General Information

Note that the PDF file name has the .pdf extension specified (below). Infoprint Server does not add an extension for you.

```

                                Add PDF map entry
Type choices, press Enter.
BCC e-mail addresses . . . _____
                                Character value, *FILE
ReplyTo e-mail address   *MAILSENDER
                                _____
                                Character value, *MAILSENDER
Mail sender . . . . . *PSFCFG      Name, *PSFCFG
PDF file name . . . . . summary.pdf
                                _____
                                Stream file, *PSFDFT
```

Figure 35. Specifying E-mail Information - Second Panel, General Information

This is a file that will be opened and added to the e-mail body after the message text.

```

                                Add PDF map entry
Type choices, press Enter.
E-mail body:
                                /home/OPERATORS/REPORT_TEXT.HTM
                                _____
                                _____
                                Character value, *NONE
```

Figure 36. Specifying E-mail Information - Third Panel, Files for E-mail Body

This panel lets you specify other files to attach to the e-mail. For this example, we don't specify any.

```

                                Add PDF map entry
Type choices, press Enter.
E-mail attachments:
                                *NONE
                                _____
                                _____
                                Character value, *NONE
```

Figure 37. Specifying E-mail Information - Fourth Panel, E-mail Attachments

This panel lets you specify security options. We will specify a master password and 128-bit encryption. After pressing Enter, the values you can specify for encryption are shown. We specify values that let the user print the document and copy text and graphics from it, and enable accessibility. Users cannot change the document in any way:

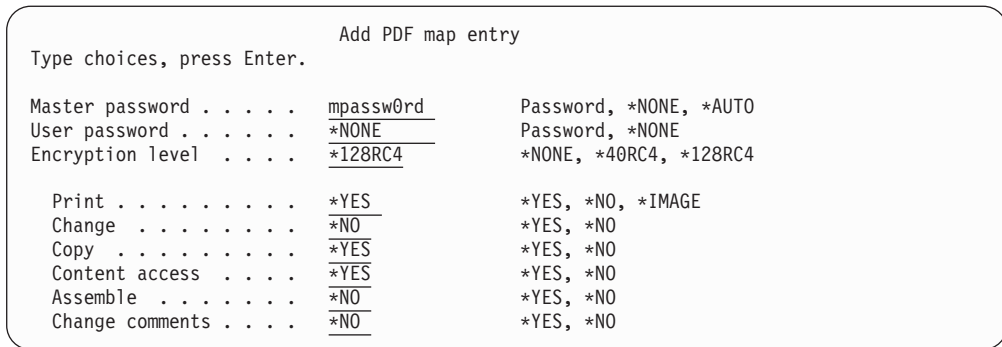

Figure 38. Specifying E-mail Information - Fifth Panel, PDF Encryption Options

This panel lets you specify information for the AFP spooled file. If we had specified other routing options, more panels would follow.

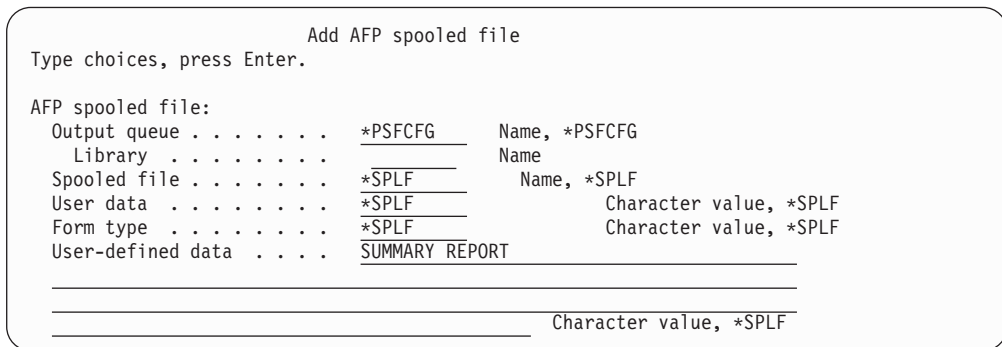

Figure 39. Specifying AFP Spooled File Information

- After filling out all of the values, press Enter. The Work with Map Entries panel is shown with your new map entry listed in the PDF mapping table:

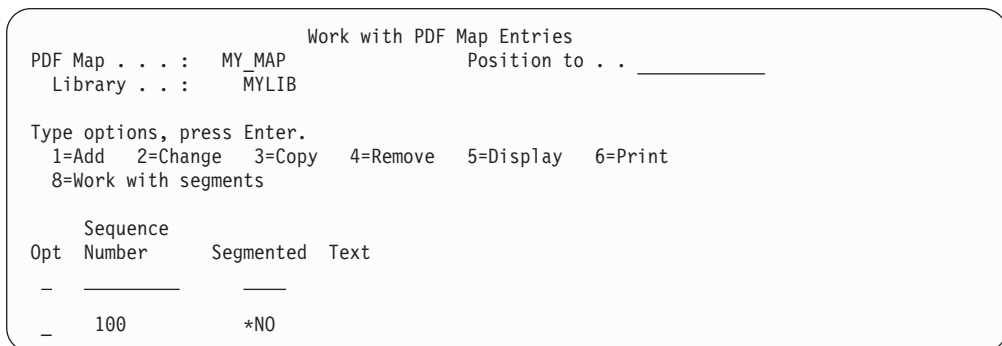

Figure 40. Work with PDF Map Entries Panel with One Entry

## Displaying or Printing a Map Object

To display or print a map object, use the Display PDF map entries (DSPPDFMAPE) command. You must specify the library-qualified name of a map object. You can also and can specify whether the output is printed to an actual printer or displayed on your monitor. By default, it is displayed on your monitor. For example, specifying this command opens the display shown in Figure 41 on page 143:

```
DSPPDFMAPE(MYLIB/MY_MAP)
```

```

PDF Map . . . : MY_MAP
Library . . . : MYLIB

PDF Map Information
Sequence
number . . . : 100

Spooled file . . . . . : *ALL
Output queue . . . . . : *ALL
Library . . . . . :
Job name . . . . . : *ALL
User . . . . . : OPER*
User data . . . . . : *ALL
Form type . . . . . : *ALL
Routing tag . . . . . : *ALL

Text . . . . . :
Segmented entry . . . . : *NO

More...

Press Enter to continue.

```

Figure 41. Displaying a PDF Map

When you print a map object, a spooled file named DSPPDFMAPE is generated with the name of the map object as the user data. This spooled file is placed on the default output queue associated with the current job. The printout is formatted in the same way as the display.

---

## Deleting a Map Object

To delete a map object, use the Delete map object (DLTPDFMAP) command and specify the map object you want to delete. You are prompted to confirm your choice before the object is deleted.

---

## Using a Map Object

To use a map object, specify it on your PSF configuration object:

1. Specify these on your PSF configuration object:
  - Specify the map object on the PDF mapping object (PDFMAP) parameter in this form:

```
PDFMAP(library/name)
```
  - On the PDF mapping program (PDFMAPPGM) parameter, specify the IBM-supplied mapping program:

```
PDFMAPPGM(*IBMPGM)
```

For example, this command changes the PSF configuration object MY\_CONFIG in library MY\_LIB to specify the IBM-supplied mapping program and the map object MY\_MAP in MY\_LIB.

```
CHGPSFCFG PSFCFG(MY_LIB/MY_CONFIG) PDFMAPPGM(*IBMPGM) PDFMAP(MY_LIB/MY_MAP)
```

For more information about setting up your PSF configuration object, see “Setting up Your PSF Configuration Object” on page 63.

2. Continue with “Configuring the Device” on page 64 in “Before Using the PDF Subsystem” on page 63.
3. Once your system is set up, follow the instructions in “Transforming a Spooled File to PDF” on page 65.

“Example” has an example of creating the map object then specifying it with the IBM-supplied mapping program.

## Using a Map Object Created on OS/400 5.2

Map objects created on 5.2 systems have a different object type than those created later systems. However, you can use map objects created on 5.2 systems on higher-level systems without changing the object. When a map object is specified on the PDF map APIs or an appropriate PSF configuration object command, PSF and Infoprint Server search for the map object in this order:

1. The specified map object with an object type of \*PDFMAP (5.3 level)
2. The specified map object with an object type of \*USRIDX (5.2 level)

The first map object found is used.

---

### Example

This example illustrates how to create, edit, and specify a map object. For more examples of using the PDF subsystem, refer to the Redbook *IBM @server iSeries Printing VI: Delivering the Output of e-business* or *Infoprint Server for iSeries: User's Guide*.

#### **Follow these steps to create, change, and use a map object for a segmented spooled file:**

This example shows how to create and change a map object with segments. It also illustrates how to specify the map object and the IBM-supplied mapping program on the PSF configuration object. In this example, we use a map object and the IBM-supplied mapping program to process our spooled file. The spooled file is a monthly sales report file that is split at group boundaries.

1. Add routing tags to the data. In this example, we use DDS to insert routing tags within a print file. The DDS STRPAGGRP (Start Page Group) and ENDPAGGRP (End Page Group) keywords identify the segment boundaries and provide a unique name to each segment.

To set this up for our sales report deployment, edit the DDS printer file for the target application to insert logical divisions between the regions. We use the printer file SALESRPT. In our example, we assume there are five logical divisions in the data: Northwest, West, Central, South, and Northeast. We provide a logical name for each region with the STRPAGGRP keyword. The DDS coding for one segment is shown below:

```

.....+.....1.....+.....2.....+.....3.....+.....4.....+.....5.....+.....6.....+.....7.....+.....
A
A      R RECORD1
A 02          STRPAGGRP('NORTHWEST')
A      R JIMDATA
A      FLD      80A      3SPACEA(1)
A      R JANETDATA
A      FLD      80A      3SPACEA(1)
A      R JEFFDATA
A      FLD      80A      3SPACEA(1)
A      R JUNEDATA
A      FLD      80A      3SPACEA(1)
A      R JILLDATA
A      FLD      80A      3SPACEA(1)
A      R ENDPAGE
A      R RECORD1
A
A

```

Figure 42. DDS Coding for File Segmentation

If you do not have access to printer file DDS, such as when you are using Infoprint Designer for document layout, you can use the CRTAFPDTA command for segmentation.

2. Create a map object by using this command:

```
CRTPDFMAP PDFMAP(mylib/mymap) TEXT('description')
```

3. Add entries to the map object to specify intelligent routing by following these steps:

- a. Enter this command: `WRKPDFMAPE PDFMAP(mylib/mymap)`

- b. On the panel that opens, specify Option 1, Add. Also specify the sequence number for the entry and whether it will be for segmented spooled files:

Work with PDF Map Entries

PDF Map . . . : mymap Position to . . \_\_\_\_\_

Library . . . : mylib

Type options, press Enter.

1=Add 2=Change 3=Copy 4=Remove 5=Display 6=Print

8=Work with segments

Sequence	Opt	Number	Segmented	Text
	<u>1</u>	<u>100</u>	<u>*YES</u>	

(No entries in table)

- c. Use the panels that follow to specify the spooled file selection criteria and the mapping actions. This is what we want to do for the northwest region:

- E-mail the northwest data as a PDF to Jim, Janet, and Jeff.
- Print one hard copy to an AFP printer and mail it to Ahmad.
- Fax a copy to Aalyah (we will respool this as AFP for use with an AFP fax program).
- Store one copy as an archive in the integrated file system.

Figure 43 on page 146 shows the Add PDF map Entry display, where you enter the filter criteria. In our example, we have a spooled file with a unique name (SALESRPT) that contains all of the regional reports:

```

                                Add PDF map entry
Segmented entry . . . . . : *YES
Sequence number . . . . . : 100
Text . . . . . : Sales reports

Type choices, press Enter.

Output queue . . . . . *ALL           Name, Generic*, *ALL
Library . . . . .                               Name
Spooled file . . . . . SALESRPT       Name, Generic*, *ALL
Job name . . . . . *ALL           Name, Generic*, *ALL
User . . . . . *ALL           Name, Generic*, *ALL
User data . . . . . *ALL        Character value, *ALL
Form type . . . . . *ALL        Character value, *ALL

                                Character value, *ALL

```

Figure 43. Adding an Entry for the Northwest Region

Next, we will create the segment entries. To create the segment for the northwest region, we specify these values, where NORTHWEST is the routing tag in the spooled file:

```

                                Work with PDF Map Segmented Entries
Sequence number . . . : 100           Job name . . . : *ALL
Spooled file : SALESRPT           User . . . . . : *ALL
Output queue : *ALL           User data . . . : *ALL
Library . . . :                               Form type . . . : *ALL
Position to . . : _____

Type options, press Enter.
  1=Add  2=Change  3=Copy  4=Remove  5=Display  6=Print

Opt Routing tag
1 NORTHWEST

(No segments in entry)

```

Figure 44. Add Segment Entry for Northwest Region

Now we define what we want done with this segment, using the criteria specified above

```

                                Add Segment Entry
Type choices, press Enter.

Routing tag . . . . . NORTHWEST
_____
_____
_____

PDF map actions:
Mail . . . . . *YES           *YES, *NO
PDF spooled file . . . *NO       *YES, *NO
AFP spooled file . . . *YES     *YES, *NO
Stream file . . . . . *YES      *YES, *NO

```

Figure 45. Specifying the Mapping action for the Northwest Segment

We will accept the default values on all of the panels except the ones shown. On the first e-mail panel, press F7 to specify more than one e-mail address, this panel opens:



```

Specify more values for To e-mail

Type TO e-mail addresses, press Enter.

TO e-mail addresses:
    jim@company.com
    janet@company.com
    jeff@company.com

```

Figure 46. Specifying E-mail Addresses for Northwest report

To specify where the AFP file is to be spooled, fill in these values:

**Note:** If your input spooled file specifies AFPRESPOOL(\*PRINT) as user-defined data, specify different user-defined data here. Otherwise, the job will not print and will be held.

```

Add AFP spooled file

Type choices, press Enter.

AFP spooled file:
Output queue . . . . . AFPQUEUE      Name, *PSFCFG
Library . . . . . MYLIB          Name
Spooled file . . . . . *SPLF          Name, *SPLF
User data . . . . . *SPLF           Character value, *SPLF
Form type . . . . . *SPLF           Character value, *SPLF
User-defined data . . . . . *SPLF

```

Figure 47. Specifying AFP Respool Parameters for the Northwest Report

Specify where to store the PDF stream file:

```

Add PDF stream file

Type choices, press Enter.

PDF stream file:
Stream file . . . . . /reports/northwest/month.pdf

```

Figure 48. Specifying PDF Stream File Parameters for the Northwest Report

Follow the same process to add segment entries for the other sales regions.

- Specify the appropriate values in a PSF configuration object. In this example, we create a new PSF configuration object. It specifies to use the IBM-supplied mapping program and the map object that we created in step 2. It also specifies to split the spooled file and create multiple spooled files. We specified AFPSAVE(\*YES) so that one or more segments can be spooled as AFP.

In order to have the spooled file sent to the PDF subsystem, we must specify something other than \*NONE for PDFGEN. However, Infoprint Server uses the values specified in the mapping program for PDFGEN and any related parameters, such as PDFSENDER.

Use this command to create a PSF configuration object that specifies segmentation and intelligent routing:

```

CRTPSFCFG PSFCFG(myconfig) PDFGEN(*MAIL) PDFMULT (*YES *SPLIT)
PDFMAILSVR (SMTP_mail_server) PDFMAPPGM(*IBMPPGM)
PDFMAP(mylib/my_map_object) AFPSAVE(*YES)
AFPOUTQ(mylib/my_outq)

```

5. Configure the device. Because PDF transform services use a virtual writer concept, we must create a printer device description for that virtual writer. These are the key parameters to specify on the CRTDEVPRT (Create Device Description, Printer) command:

```

TYPE(*IPDS)
DEVCLS(*LAN)
MODEL(0)
LANATTACH(*IP)
AFP(*YES)
PORT(nnnn)
RMTLOCNAME(127.0.0.1)
USRDFNOBJ(mylib/myconfig *PSFCFG)

```

*nnnn* is a unique port number and the IP address 127.0.0.1 is a loopback address that identifies this writer as a virtual writer. The USRDFNOBJ (User Defined Object) specifies the PSF configuration object created in step 4.

6. Vary on the device:

```
VRYCFG CFGOBJ(myconfig) CFGTYPE(*DEV) STATUS(ON)
```
7. Start the writer:

```
STRPRTWTR(device)
```
8. We can place this new distribution into production simply by routing the monthly sales report to the PDF device (writer) we created in Step 5. All the segmentation, PDF transformation, and routing will take place automatically.

---

## Error Situations

There are different ways Infoprint Server will treat your spooled file when there is an error in matching to a map object entry. This could happen when no match is found for an input spooled file or when no match is found for a spooled file segment:

- **When there is a PDF administrator defined**, the PDF administrator is notified of the error in an e-mail with the PDF file attached. This PDF file is not encrypted, even when encryption is specified. The input spooled file is held, and if there are more segments to process, processing continues.
- **When there is no PDF administrator defined**, the input spooled file is held, and processing stops.

The PDF administrator is specified on the PSF configuration object's PDFADMIN parameter.

Additionally, if there is a syntax error in a specified To, BCC, CC, or reply-to e-mail address for a PDF file, that PDF is not e-mailed to any of those addresses. If an administrator is specified, the PDF file is sent to that address and processing continues. If no administrator is specified, processing stops.

---

## Chapter 6. Sending E-mail

The PDF subsystem lets you transform a spooled file to PDF and e-mail it. You can use a specified SMTP mail server or the i5/OS Send Distribution (SNDDST) command to send the e-mail. The input spooled file can be any type of file that PSF can print. The e-mail function is flexible, so you can use it to accomplish both simple and complex tasks. For example, you can use it to send one file to one recipient, or divide one file into many files and send each file to a different recipient.

**Note:** The PDF subsystem interacts with PSF to transform data and send e-mail. However, you do not need a PSF for i5/OS license to use the PDF subsystem.

With a mapping program you can name the PDF file, specify encryption for the PDF file, resolve routing tags, specify the subject text, and add a customized message to the beginning of each e-mail. If you use an SMTP server to send the e-mail, you can also use a mapping program to specify carbon copy (cc), blind carbon copy (bcc), and return-to addresses, a file to use as the e-mail body, and attachments.

**Note:** If you do not specify a name for the PDF file, PSF gives it a default name that ends in the sequence number (such as 000001.pdf). This sequence number is prepended by an X if the file is encrypted.

This chapter explains how to use the e-mail function, how to recover from errors, and how to use the mapping program. The table below lists the tasks associated with sending e-mail and specifies whether they are required to send e-mail with Infoprint Server.

*Table 9. E-mail Tasks*

Task	Page	Required
Enabling Your i5/OS to Send E-Mail	150	Yes
Setting up the i5/OS as a POP E-mail Client	153	No
Creating a PSF Configuration Object	153	Yes
Configuring the Device	64	Yes
Varying the Device ON	65	Yes
Starting the Writer	65	Yes
Using Routing Tags	153	No
Using the PDF Mapping Program	177	No*
Creating a Map Object	104	No*
Insert Routing Tags into the Data	76	No
Using AFP Manager to Send E-mail	155	No
Checking for Non-delivery Messages	156	No
Setting QUTCOFFSET	157	No

\* One of these is required if you are using routing tags that are not valid e-mail addresses.

**Note:** When using an SMTP server to send e-mail, PSF must establish a connection with the server each time it wants to send an e-mail. For example, if you want to send 10 e-mails, PSF must establish a connection with the SMTP server 10 times.

---

## Steps to Send a PDF File as E-mail

To send a PDF file as e-mail, follow these steps or use AFP Manager to access the PDF subsystem. For information about using AFP Manager to access the PDF subsystem, see "Accessing the PDF Subsystem with iSeries Access" on page 67.

### Before you begin:

You must have all of these to successfully send an e-mail:

- An i5/OS system enabled to send e-mail. See "Enabling Your i5/OS to Send E-Mail."
- An i5/OS system set up as a POP server (optional, but required to receive e-mail). See "Setting up the i5/OS as a POP E-mail Client" on page 153.
- An appropriate PSF configuration object. See "Creating a PSF Configuration Object" on page 153 and "Varying the Device ON" on page 65.
- A properly configured device varied on with a started writer. See "Configuring the Device" on page 64 and "Starting the Writer" on page 65.

### Steps to send a PDF file as e-mail:

1. Modify the input file to add routing tags (optional). See "Using Routing Tags" on page 153.
2. Create a mapping program (optional). See Appendix B, "Mapping Program," on page 177 and Appendix C, "Templates," on page 209.
3. Move the spooled file to the output queue associated with a properly configured device.

---

## Enabling Your i5/OS to Send E-Mail

Infoprint Server can convert a spooled file to PDF and send it as e-mail. The input spooled file can be any type of data that PSF can print. To send a file as e-mail, your i5/OS must be properly configured.

**Note:** These instructions are for setting up your i5/OS to send outgoing e-mail. If you want to e-mail PDF documents to local i5/OS user accounts, you must also set up your system to receive e-mail. See "Setting up the i5/OS as a POP E-mail Client" on page 153 for information about setting up your system to receive e-mail.

These instructions are for users in an environment that meet all of these requirements:

- TCP/IP is configured.
- E-mail has not been set up before.
- You want to use the command line to configure your system for sending e-mail.
- You want to send e-mail with Infoprint Server.

If you use iSeries Navigator or Operations Navigator, you can follow the steps in the iSeries Information Center to set up your system to send e-mail. To find these instructions, go to Networking►TCP/IP applications, protocols, and services►E-mail►Configure e-mail.

## Steps to Enable Your i5/OS to Send E-mail

These are the steps required to set up your i5/OS to send e-mail with Infoprint Server 5.2 and higher. Enter the commands with the given parameters and values as shown in capital letters below. If you prefer, enter the command (such as CHGDSTA), then press F4 to be prompted through the command. Pressing F11 toggles between the parameter keywords (such as SMTPRTE) and a list (sometimes partial) of acceptable values for that parameter.

1. Specify the user ID and address that the mail services will use to route mail that has an internet address as a recipient.

This is not the ID of an actual person. For this example, we use INTERNET as the user ID and GATEWAY for the address. We will create a directory entry with this user ID and address in step 2. On the command line, enter:

```
CHGDSTA SMTPRTE(INTERNET GATEWAY)
```

**Restriction:** You need security administrator (\*SECADM) authority to use this command.

2. Create a directory entry that the mail services will use to route mail that has an internet address as a recipient.

User ID and Address must be the same values you specified for User ID and Address in step 1. On the command line, enter:

```
ADDIRE USRID(INTERNET GATEWAY) USRD('Generic Internet user') SYSNAME(INTERNET)
      PREFADR(NETUSRID *IBM ATCONXT)
```

3. Specify that outgoing e-mail messages are not split apart and specify that the POP mail servers are started when TCP/IP is started. On the command line, enter:

```
CHGPOPA MSGSPLIT(*NOMAX) AUTOSTART(*YES)
```

4. Configure the SMTP server to specify that it is started when TCP/IP is started and to specify the mail router to use to get through the Firewall, if you have one. If you exchange e-mail with Domino® servers, specify \*NO for Percent routing character (PCTRTGCHR) along with the parameters listed below. On the command line, enter:

```
CHGSMTPA AUTOSTART(*YES) MAILROUTER('mailrouter') FIREWALL(*YES)
```

A value for MAILROUTER is required only if you want to control what happens when a name and address cannot be resolved. The mail router name would typically be set up by the system administrator. Specify MAILROUTER(\*NONE) if you are unsure.

Specify a value other than \*NONE for ALYRLY if you want to use the local SMTP server.

To provide for outgoing mail and yet to protect this server from being an open relay, prevent it from relaying any e-mail except that which originates on itself (127.0.0.1). Enter these commands:

```
CHGSMTPA ALWRLY(*LIST)
ADDSMTPLE TYPE(*ACCEPT) INTNETADR('127.0.0.1')
```

5. Create user profiles for any users who want to send e-mail. We will create user JOEJ. Enter:

```
CRTUSRPRF USRPRF(JOEJ) PASSWORD(not2bad) TEXT('Joe Johnson')
```

6. Add users to the system distribution directory. The value for USER must be the same as the value for USRPRF specified in step 5. To use this ID to send e-mail, specify this user ID in the PDFSENDER parameter of the PSF configuration object used with the PDF subsystem. Alternatively, you can specify it in USRDFNDDTA in the spooled file's attributes or the printer file. ISERIES is the system name of the iSeries that Joe works on. Enter:

```
ADDIRE USRID(JOEJ ISERIES) USRD('Joe Johnson') USER(JOEJ)
```

7. **Note:** Only complete this step if you want to use an SMTP server to send e-mail with Infoprint Server. This step requires \*SECADM special authority. Enter this command to add SMTP addresses for the users in the system distribution directory:

```
CHGDIRE USRID(name address) USRDFNFDL((SMTPAUSRID SMTP 'user-id')
(SMTPDMN SMTP 'smtp-address'))
```

For example, use this command to add an SMTP address for the user ID JOEJ, who's entry specifies the SNADS address as ISERIES. His Internet e-mail address is JOEJ@SUPERSUNSEEDS.COM:

```
CHGDIRE USRID(JOEJ ISERIES) USRDFNFDL((SMTPAUSRID SMTP 'JOEJ')
(SMTPDMN SMTP 'SUPERSUNSEEDS.COM'))
```

Alternatively, follow these steps to add SMTP addresses for the users in the system distribution directory:

- a. To add an SMTP address for the user ID JOEJ, enter WRKDIRE and press Enter.
- b. Choose option 2 (Change) by the user ID you want to change and press Enter.
- c. Press F19 (Add name for SMTP). If there is no SMTP address associated with this ID, a message appears on the bottom of the screen. Press Enter.
- d. Specify either the SMTP user ID and domain or the SMTP route. We specify the user ID and domain of Joe's Internet e-mail address: JOEJ@SUPERSUNSEEDS.COM.

Add Name for SMTP

System: ISERIES

Type choices, press Enter.

User ID . . . . . : JOEJ  
Address . . . . . : ISERIES

**SMTP user ID . . . . . JOEJ**  
**SMTP domain . . . . . SUPERSUNSEEDS.COM**

SMTP route . . . . .

F3=Exit F4=Prompt F12=Cancel

8. Stop the TCP/IP server. Enter ENDTCPVSR SERVER(\*SMTP)
  9. Start the TCP/IP server. Enter STRTCPSVR SERVER(\*SMTP)
- You can now test the new e-mail setup by using the SNDDST command. We suggest you do this before testing Infoprint Server for the first time.

10. Test the e-mail setup by entering this command. You can use the TOUSRID or TOINTNET parameters or both:

```
SNDDST TYPE(*LMSG) TOINTNET((me@mysystem.com)) DSTD('E-mail')
      LONGMSG('This is a test to verify that my new e-mail setup works.')
      SUBJECT('E-mail test')
```

11. Go to your Internet mail system or i5/OS to see if you have received the message. For instructions about using SNADS to receive e-mail on your i5/OS, refer to the iSeries Information Center. From the Information Center go to Networking → TCP/IP → E-mail → Send and receive e-mail on the iSeries → Use SNADS to receive e-mail.

For more information about these commands, refer to the i5/OS online help, the iSeries Information Center, or the i5/OS Service Web Page at:  
<http://www.ibm.com/servers/eserver/iseries/service>

---

## Setting up the i5/OS as a POP E-mail Client

You must set up your i5/OS as a POP e-mail client if you want to do any of these:

- Receive e-mail
- Receive error messages when your mail cannot be delivered by another server
- Use your i5/OS as an SMTP server to send e-mail

For instructions, refer to "Set up POP e-mail clients" in the iSeries Information Center. To find this topic, from the Information Center go to Networking → TCP/IP → E-Mail → Send and Receive E-mail on iSeries → Set up POP e-mail clients.

---

## Creating a PSF Configuration Object

You need a PSF configuration object to tell PSF to transform the spooled file to PDF and send it as e-mail. To create a PSF configuration object for sending e-mail, enter this command:

```
CRTPSF CFG PSFCFG(name_of_configuration_object) PDFGEN(*MAIL)
```

You can use the PDFMAILSVR, PDFSENDER, PDFMAPPGM, and PDFMAP parameters to further customize the e-mail characteristics. For information about the parameters you can specify with CRTPSF CFG, see "PSF Configuration Object Parameters" on page 82 and the CRTPSF CFG Command Description topic in the iSeries Information Center.

You can use AFP Manager, a component of iSeries Access 5.2 and higher, to create and change PSF configuration objects. For information about using AFP Manager to work with PSF configuration objects, refer to *iSeries Guide to Output*.

---

## Using Routing Tags

A routing tag specifies where the e-mail is sent. It can be a valid e-mail address (in the form *name@domain*) or it can be a keyword, like a customer number. If the routing tag is a keyword, use a mapping program to interpret it. You can put routing tags in the printer file, in the data, or in both. If you specify a mapping program, all of the tags will be interpreted by the mapping program. If you do not specify a mapping program, all routing tags must be a valid e-mail address.

To use routing tags you must complete these tasks:

- Put the routing tags in the printer file or input file.

- Create a mapping program or a map object if the routing tags are not valid e-mail addresses.
- Specify the mapping program or map object, if one is used, on the PSF configuration object. If you specify a map object, you must specify the IBM-supplied mapping program.

## Inserting a Routing Tag in the Printer File

To add a routing tag in the printer file *file-name*, enter this command:

```
CHGPRTF FILE(library file-name)
      USRDFNDA('MAILTAG(tag-name)MAILSENDER(mail-sender-name)')
```

The tag name can be up to 80 characters long. If the routing tag is not a valid e-mail address, you must specify a mapping program on the PSF configuration object PDFMAPPGM parameter.

MAILSENDER is optional. If you use it, MAILSENDER overrides the PDFSENDER parameter on the PSF configuration object. The mail sender name can be up to 10 characters long. MAILSENDER must be a valid user profile and must have a directory entry in the system distribution directory. For using SMTP mail servers, you must have an SMTP address in the system distribution directory. Use Display Directory Entries (DSPDIRE) to view the entry in the System Distribution Directory and Work with Directory Entries (WRKDIRE) to change an entry. For more detailed information about working with the System Distribution Directory, see “Enabling Your i5/OS to Send E-Mail” on page 150. For information about using a printer file, refer to *iSeries Guide to Output*.

## Inserting a Routing Tag in the Spooled File

You can add a routing tag or specify the mail sender after the file is spooled. If you do this, it overrides any value previously specified for MAILTAG or MAILSENDER in the printer file. To add a routing tag to the file after it has been spooled, enter this command:

```
CHGSPLFA FILE(file-name) JOB(fully-qualified-job-name) SPLNBR(spooled-file-number)
      USRDFNDA('MAILTAG(tag-name)MAILSENDER(mail-sender-name)')
```

Alternatively, you can follow these steps:

1. Enter WRKSPLF.
2. Specify option 2 “Change Spooled File Attributes” by the spooled file you want to change.
3. Press F9 “All parameters”.
4. Change the User defined data (USRDFNDA) parameter:  
 USRDFNDA('MAILTAG(*tag-name*)MAILSENDER(*mail-sender-name*)')

The tag name can be up to 80 characters long. If the routing tag is not a valid e-mail address, you must specify a mapping program that converts the routing tag to an e-mail address. Specify the mapping program on the PSF configuration object PDFMAPPGM parameter. For information about using a mapping program, see Appendix B, “Mapping Program,” on page 177 and Appendix C, “Templates,” on page 209.

MAILSENDER is optional. If you use it, MAILSENDER overrides the PDFSENDER parameter on the PSF configuration object. The mail sender name can be up to 10 characters long. MAILSENDER must be a valid user profile and must have a directory entry in the system distribution directory. For using SMTP mail servers, you must have an SMTP address in the system distribution directory. Use Display



Directory Entries (DSPDIRE) to view the entry in the System Distribution Directory and Work with Directory Entries (WRKDIRE) to change an entry. For more detailed information about working with the System Distribution Directory, see “Enabling Your i5/OS to Send E-Mail” on page 150.

## Inserting a Routing Tag in the Input File

For DDS print applications, you can put a routing tag on the DDS STRPAGGRP keyword. See “Using DDS to Insert Routing Tags” on page 76 for information about using DDS to insert a routing tag in the input file. For more information about using DDS, refer to *DDS Reference*.

You can use the CRTAFPDTA indexing function to generate multiple PDF files and e-mail them. For instructions, see “E-mailing the CRTAFPDTA Output” on page 34.

---

## Using AFP Manager to Send E-mail

AFP Manager is a plug-in to iSeries Navigator, a component of iSeries Access. Unless otherwise specified, iSeries Navigator refers to both iSeries Navigator and Operations Navigator. You can use AFP Manager to select spooled files to convert to PDF and send as e-mail. If you want to send the e-mail to many people, you should use routing tags and a mapping program because of performance considerations.

### Before You Begin

- Make sure that you have a PSF configuration object that tells PSF to transform the spooled file into a PDF file.

There are several ways to create a new PSF configuration object or modify an existing one:

- To use AFP Manager to create a PSF configuration object, follow these steps:

1. Double-click the iSeries Access icon.
2. Double-click the iSeries Navigator icon.
3. Open a connection to a 5.2 or higher server.
4. Expand **AFP Manager**.
5. Right-click **PSF Configurations** and select **New...**
6. For OS/400 5.3 and higher, on the PDF Destinations page, select **Generate PDF** and **Send as electronic mail**. Specify any other values you want. For help on any field, select the field and press F1.
7. For OS/400 version 5.2, on the PDF Transform page, select **Generate PDF** and **Send as electronic mail**. Specify any other values you want. For help on any field, select the field and press F1.
8. Click **OK**.

- Run the command Create PSF Configuration (CRTPSFCFG) or Change PSF Configuration (CHGPSFCFG) from the i5/OS command line. Specify PDFGEN (\*MAIL). You can specify other appropriate values as described in “Setting up Your PSF Configuration Object” on page 63.
- Run the command Create PSF Configuration (CRTPSFCFG) or Change PSF Configuration (CHGPSFCFG) from iSeries Navigator. Specify PDFGEN (\*MAIL). You can specify other appropriate values as described in “Setting up Your PSF Configuration Object” on page 63. For steps to run an i5/OS command from iSeries Navigator, refer to *iSeries Guide to Output* or the iSeries Information Center topic “Running commands with Management Central”. To find the topic, from the Information Center go to Connecting to iSeries →

What to connect with → iSeries Navigator → Management Central → Working with Management Central → Run Commands.

- Make sure that the writer that processes the spooled files is configured properly. To configure a writer to transform a spooled file to PDF, run the Create Device Description, Printer (CRTDEVPRT) or Change Device Description, Printer (CHGDEVPRT) command. Specify the values listed in “Configuring the Device” on page 64. You can use iSeries Navigator or the i5/OS command line to run commands. For steps to run an i5/OS command from iSeries Navigator, refer to *iSeries Guide to Output* or the iSeries Information Center topic “Running commands with Management Central”. To find the topic, from the Information Center go to Connecting to iSeries → What to connect with → iSeries Navigator → Management Central → Working with Management Central → Run Commands.

## Steps to Create a PDF File and Send it as E-mail

1. In iSeries Navigator, expand **My Connections** (or your active environment).
2. Expand a 5.2 or higher system.
3. Expand **Basic Operations** and select **Printer Output**.
4. Right-click the output files you want to convert and select **Convert to PDF...** . The **Convert Printer Output to PDF** dialog opens with the specified printer output files in the **Printer output** list.
5. Select **Send as electronic mail**.
6. Specify whether to use the mapping program specified on the PSF configuration object. If you use the mapping program, PSF sends the e-mail to all recipients specified in the mapping program as well as the recipients specified in the **To:** field.
7. Specify the device that PSF should use to convert the printer output file. You can specify the library-qualified output queue, the printer whose queue is going to do the conversion, or both.
8. Use the **To:** field to specify where the e-mail is sent. Separate addresses with a space or comma, or put them on separate lines.
9. Click **OK**.

A new spooled file is created for each spooled file you selected. For help with any field, select the field and press **F1**.

---

## Checking for Non-delivery Messages

When an e-mail is sent and either the destination user name or the domain is incorrect, a message is returned to the reply to address, if one is specified. Otherwise, the message is sent to the e-mail sender. The reply to address is specified on a mapping program. The e-mail sender can be specified in two ways:

- on the PDFSENDER parameter in the PSF configuration object that the PDF subsystem uses
- on the printer file or the spooled file by specifying a value for MAILSENDER on USRDFNDTA

If both are specified, the MAILSENDER value overrides the PDFSENDER value.

Some thought should be given as to how you set up and manage the sender user ID for the PDF subsystem. If you set up your PSF configuration object with the default value of PDFSENDER(\*SPLFOWN), you might have to enroll many different users so they can receive non-delivery messages. For business critical applications, consider setting up a special user ID for the e-mail sender or reply to

address and have one person responsible for checking for messages and taking appropriate action, such as contacting the intended recipient and re-sending the document.

Use the PSF configuration object PDFMAILSVR parameter to specify how the e-mail is sent. You can specify the SNDDST command or an SMTP server. If you are using SMTP to send the e-mail and a client is configured to receive e-mail for the e-mail sender, no extra setup is required.

The SNDDST command does not have a specific vehicle to check for these incoming messages, but they are accessible and should be monitored. To receive non-delivery messages when you specify that SNDDST is used to send the e-mail, set up a Post Office Protocol Version 3 (POP3) client associated with the sender's user ID. To do this, map the sender's entry in the system distribution directory to an SMTP address, such as *name@domain*.

For information about other errors when sending e-mail, see "Error Recovery" on page 98.

## Setting up a POP3 Client for a SNDDST Sender

1. Enroll the sender in the System Directory. See step 6 on page 152.
2. Associate the sender's user ID with an SMTP user ID. See step 7 on page 152.
3. Configure a client to receive e-mail for that user. There are many software products that can be used to act as a client to the iSeries POP3 server. These include clients such as Eudora and Netscape. Configuration steps depend on the product's individual interface. However, the information you provide is basically the same.

### Example:

This example uses Netscape Mail as the client.

- a. Open a Netscape Navigator window.
- b. Expand the **Edit** menu and select **Preferences**.
- c. In the left pane expand **Mail & Newsgroups** and select Mail Servers.
- d. Click **Add**.
- e. On the **General** page, enter these values:

In the **Server Name** field, enter the SMTP domain that you specified in step 2.

In the **Server Type** field, select POP3 Server.

In the **User Name** field, enter the user ID you created for the e-mail sender or reply to address.

When the e-mail sender or reply-to ID retrieves mail, he is prompted for the iSeries password for that user ID.

---

## Setting QUTCOffset

The time stamp placed into the e-mail is in Greenwich Mean Time (GMT) unless the system value QUTCOffset (Coordinated Universal Time Offset) is set according to your geographic location. If QUTCOffset is not set correctly, the time stamp might be incorrect. These are some of the appropriate values:

*Table 10. Appropriate Time Offsets*

<b>City</b>	<b>Offset</b>
London	+00:00
Montreal	-05:00
Riyadh	+03:00
San Francisco	-08:00
Tokyo	+09:00

---

## Chapter 7. Transforming PCL, PDF, and PostScript Data to AFP

This chapter describes how to use Infoprint Server's Transform Manager feature (feature number 5101 for PostScript and PDF and 5202 for PCL) to convert PCL, PDF, and PostScript to AFP. It contains this information:

- "Overview" describes how these transforms work.
- "Syntax" on page 160 gives the command syntax.
- "Planning for the PCL, PDF, or PostScript to AFP Transforms" on page 161 describes what you need to do before using the transforms.
- "Transforming Data" on page 167 explains how to use the transforms.
- "Font Downloader" on page 169 describes how to use the Font Downloader with the PostScript to AFP transform.
- "Troubleshooting" on page 171 lists some common problems and explains how to fix them.

---

### Overview

These transforms can convert the following data streams to image-based Advanced Function Presentation (AFP) format for printing on IBM AFP printers:

- Printer Control Language (PCL) 6
- Portable Document Format (PDF) 1.3
- PostScript Language Level 3

**Note:** You must have PSF installed to print on AFP (IPDS) printers.

When a spooled file is released and has one of the data formats for which a transform is provided, an i5/OS AFP printer writer can automatically call image print transform. Next, image print transform calls the appropriate transform program. The PDF, PCL, or PostScript data is then converted to an AFP image to preserve fidelity and printed on the IPDS printer. If you want a printer writer to automatically use a transform, you must configure the printer writer appropriately. See "Setting Up the Printer Device Description" on page 166 for information about configuring the printer writer.

Each transform can output data suitable for printing on two types of printers: edge-to-edge and no-print border. Edge-to-edge printers have no set margin. No-print border printers have a set .167 inch margin.

Figure 49 on page 160 shows how data is transformed from PCL, PDF, or PostScript to AFP, after the transforms have been enabled on your i5/OS™:

1. A PCL, PDF, or PostScript job is sent to image print transform.
2. Image print transform calls the appropriate exit program.
3. The exit program requests a transform from Transform Manager and tells Transform Manager the image configuration object type. This tells Transform Manager what type of transform is needed.
4. When there is no transform process available, Transform Manager either starts a new transform process or waits for one to finish. For information about how

Transform Manager determines when to start a new transform job, see “Configuring Transform Manager” on page 162.

5. Transform Manager starts an appropriate transform if necessary.
6. The exit program sends the PCL, PDF, or PostScript data to the transform.
7. The transform sends the transformed job to the exit program. If Transform Manager started this transform job to fulfil a request, the transform job ends.
8. The exit program sends the AFP data to image print transform.
9. Image print transform sends the AFP data to PSF.
10. PSF prints the image-based AFP data on an IPDS printer.

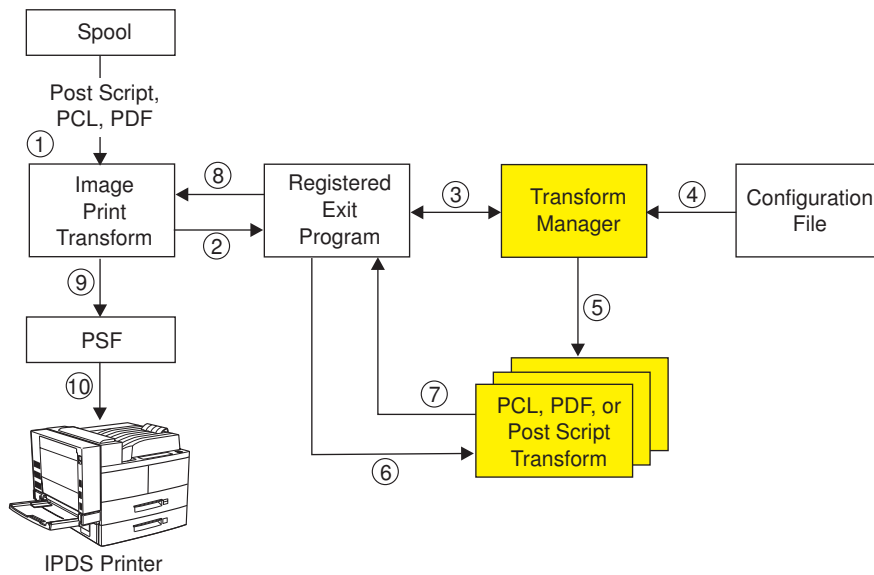

Figure 49. Transforming PCL, PDF, and PostScript data to AFP Data.

## Syntax

Figure 50 shows the command syntax used to start Transform Manager.

### Start Transform Manager

▶▶—STRTFMMGR—◀◀

Figure 50. Starting Transform Manager

Figure 51 shows the command syntax used to end Transform Manager.

### End Transform Manager

▶▶—ENDTFMMGR—◀◀

Figure 51. Ending Transform Manager

---

## Planning for the PCL, PDF, or PostScript to AFP Transforms

Before transforming PCL, PDF, or PostScript data, you need to do the following:

- Ensure that you have the necessary authority. See “Authorities.”
- Ensure that your system is able to run the transform. See “System Requirements.”
- Create the **work** directory. See “Configuring Transform Manager” on page 162.
- Configure Transform Manager. See “Configuring Transform Manager” on page 162.
- Customize the PostScript to AFP transforms (optional). See “Customizing the PostScript to AFP and PDF to AFP Transforms” on page 164.
- Start Transform Manager. See “Starting and Ending Transform Manager” on page 166.
- Set up the printer device description. See “Setting Up the Printer Device Description” on page 166.
- Increase the maximum memory setting - optional. See “Increasing the Maximum Memory Setting” on page 165.

### Authorities

To issue the STRTFMMGR command, you must have \*JOBCTL special authority.

### System Requirements

In order to use the PCL, PDF, or PostScript to AFP transform, you need a V5R1 or higher OS/400, with the PASE feature installed. If you issue the STRTFMMGR command on a system that does not have PASE installed, a message is issued and Transform Manager does not start.

### Creating the Work Directory

You must create the **work** directory with the proper authorities in order for Transform Manager to work properly. Create this path on your system with the specified owner and permissions:

```
/QOpenSys/QIBM/UserData/InfoprintServer/Transforms/work
```

Table 11. Directories to Create for Transform Manager

Directory	Owner	Permissions
InfoprintServer	QIPSJOB	755
Transforms	QIPSJOB	755
work	QIPSJOB	700

To change the directory information, follow these steps:

1. Call `qp2term` from the command line.
2. Specify `cd` to change to the directory that contains the directory you want to edit. For example, `cd /QOpenSys/QIBM/UserData/` allows you to edit the InfoprintServer directory.
3. Specify `chown new_owner directory` to change the directory owner. For example, `chown QIPSJOB InfoprintServer` makes QIPSJOB the owner of InfoprintServer.

4. Specify `chmod new_permissions directory` to change the directory permissions. For example, `chmod 755 InfoprintServer` makes 755 the permissions for InfoprintServer.

**Note:** There cannot be anything in the **work** directory.

## Configuring Transform Manager

When you configure Transform Manager, you can specify these:

- The number of each type of transform to initialize when Transform Manager is started.
- The maximum number of each type of transform that can be active.

For example, you can specify that Transform Manager starts five PCL edge-to-edge transforms upon startup, and that no more than ten PCL edge-to-edge transforms can run simultaneously. The appropriate values for minimum and maximum active depend on your print environment. To make an informed decision, you must understand how Transform Manager starts and ends transform jobs:

1. At startup, Transform Manager starts the specified minimum number of each type of transform.
2. When a writer gets a job that needs to be transformed, it tries to get control of an appropriate transform. There are several possible outcomes to this:
  - An appropriate transform is available. In this situation, the writer gives the job to that transform. The selected transform does not take any new jobs until it is done transforming the current job.
  - No appropriate transform is available and the maximum number of that type of transform has not been started. In this situation, Transform Manager starts the appropriate transform. The job waits while the transform starts, and after the job is transformed, the transform ends.
  - No appropriate transform is available and the maximum number of that type of transform has been started. In this situation, the writer waits until a transform becomes available or until the maximum is no longer reached.

You should avoid starting new transform jobs frequently, having lots of extra transforms active, and having writers frequently waiting for transforms. Specify **minimum active** and **maximum active** so they reflect your estimated transform needs.

To configure Transform Manager, follow these steps:

1. Copy the configuration file `qxtrtfmmgr.cfg` from `/QOpenSys/QIBM/ProdData/InfoprintServer/Transforms/` into `/QOpenSys/QIBM/UserData/InfoprintServer/Transforms/`.

IBM recommends that you copy the file by entering the following on the command line:

```
CPY OBJ('/QOpenSys/QIBM/ProdData/InfoprintServer/Transforms/qxtrtfmmgr.cfg')
TOOBJ('/QOpenSys/QIBM/UserData/InfoprintServer/Transforms/qxtrtfmmgr.cfg')
```

You can also use iSeries Navigator to copy the file.

2. Specify appropriate values for **minimum active** and **maximum active**. Use the EDTF command from the i5/OS command line to edit the configuration file. Blank lines and lines that start with a pound sign (#) are ignored.

### Notes:

- a. The values specified for **PS Transforms** apply to both PostScript and PDF transforms.



- b. The configuration file is encoded in **EBCDIC** and must remain so to obtain the expected results.
- c. The CCSID of the configuration file must be 037. The CCSID might be unintentionally changed by using the copy commands from Windows or from the qp2term shell. You can use iSeries Navigator to verify the CCSID.
- d. Do not change anything in the configuration file except the values for minimum active and maximum active.

Figure 52 shows the default configuration file.

```
#
# Infoprint Server Default Transform Manager Configuration file
#

PS Transforms:
image config type = EdgeToEdge
minimum active = 1
maximum active = 1

PCL Transforms:
image config type = EdgeToEdge
minimum active = 1
maximum active = 1

PS Transforms:
image config type = NoPrintBorder
minimum active = 1
maximum active = 1

PCL Transforms:
image config type = NoPrintBorder
minimum active = 1
maximum active = 1
```

*Figure 52. Default Configuration File*

Keywords:

#### **PS Transforms**

This tag identifies the start of a PostScript transform configuration block. Two PostScript configuration blocks are required; one for edge-to-edge jobs and one for no-print border jobs.

#### **PCL Transforms**

This tag identifies the start of a PCL transform configuration block. Two PCL configuration blocks are required; one for edge-to-edge jobs and one for no-print border jobs.

#### **image config type**

This field identifies the type of image configuration object that is specified on the device description of the printer writer. Jobs from this writer either go to an edge-to-edge transform or one with a no-print border. The printer that the image configuration object is for determines which. See “Setting Up the Printer Device Description” on page 166 for more information about the image configuration object.

#### **minimum active**

This field specifies the number of transform processes that Transform Manager starts, and the minimum number of transform processes that Transform Manager keeps active. Specify a value in the range 0-32767. The default is 1.

### maximum active

This field specifies the maximum number of transform processes that Transform Manager makes active. When this number is reached, Transform Manager does not start a new transform process to perform a transform. Therefore, the transform request waits until a transform process is available. This value must be greater than the value specified for **minimum active**. Specify a value in the range 1-32767. The default is 1.

### Example

The following example specifies the following:

- No transforms are initialized to process data for PCL, PDF, PostScript edge-to-edge jobs, but one transform can start.
- At least five, but no more than 10 transforms are started to process PostScript and PDF data for jobs with a no-print border.
- At least three, but no more than 10 transforms are started to process PCL data for jobs with a no-print border.

```
PS Transforms:  
image config type = EdgeToEdge  
minimum active = 0  
maximum active = 1
```

```
PCL Transforms:  
image config type = EdgeToEdge  
minimum active = 0  
maximum active = 1
```

```
PS Transforms:  
image config type = NoPrintBorder  
minimum active = 5  
maximum active = 10
```

```
PCL Transforms:  
image config type = NoPrintBorder  
minimum active = 3  
maximum active = 10
```

## Customizing the PostScript to AFP and PDF to AFP Transforms

You might want to customize the PDF and PostScript to AFP transform in one of these ways:

- “Adding Fonts” lets you print documents with fidelity when the needed font is on your system.
- Increasing the Maximum Memory Setting. Do this if you are experiencing memory errors when transforming PDF files to AFP. See page 165.

### Adding Fonts

You can add fonts to the PostScript to AFP and PDF to AFP transforms. This lets you print documents with fidelity when the needed font is on your system. To add fonts to the transform, edit the font mapping file. The font mapping file is encoded in ASCII.

To edit the font mapping file, create the file **fonts.map** in this path `/QOpenSys/QIBM/UserData/InfoprintServer/Transforms/ps2afp/fonts`. Add any fonts to this file that are not mapped in **fonts.map** in the ProdData path: `/QOpenSys/QIBM/ProdData/InfoprintServer/Transforms/ps2afp/fonts`. The format of each entry in the file is:

```
font name path
```

*name* specifies a font name and *path* specifies the path where it is stored. For example, these are some of the entries in **font.map** in the ProdData path:

```
font BookMaster /QOpenSys/QIBM/ProdData/InfoprintServer/Transforms/ps2afp/fonts/BookMaster
font BookMaster-Bold
  /QOpenSys/QIBM/ProdData/InfoprintServer/Transforms/ps2afp/fonts/BookMaster-Bold
font BookMaster-BoldItalic
  /QOpenSys/QIBM/ProdData/InfoprintServer/Transforms/ps2afp/fonts/BookMaster-BoldItalic
```

When a new transform is started, Transform Manager checks for **fonts.map** in the UserData path. If it is not found, only the **fonts.map** in the ProdData path is used. If it is found, the file in the UserData directory is checked for a font first. If the font is not mapped there, the **fonts.map** file in the ProdData path is searched.

#### Notes:

1. Ensure that the path in **fonts.map** points to the correct font file.
2. The data in **fonts.map** in the UserData path takes precedence over the data in **fonts.map** in the ProdData path. If the same font is mapped in both places, the path specified in **fonts.map** in the UserData path is used.
3. Only a system administrator should change **fonts.map**. If there are incorrect entries in **fonts.map**, Transform Manager will not start.

### Increasing the Maximum Memory Setting

Some incoming PDF data streams require more memory than others to transform successfully. The amount of memory required is affected by the size of the incoming PDF file and, more importantly, the way the PDF data stream was constructed. By default, 24M of memory is provided for the PDF and PostScript to AFP transform. If you suspect that your jobs are failing with memory failures, increase the maximum amount of memory available for the transform. This increase of memory should not affect other portions of the system.

IBM recommends that you increase the limit to the maximum value allowed (99M) to verify that you are experiencing memory failures. If the error is corrected by increasing the memory limit, IBM recommends that you leave the memory limit at the maximum value since there is minimum effect of keeping the limit at the maximum level.

To increase the maximum limit for the PDF and PostScript to AFP transform, change the default configuration file. This change will affect all subsequent instances of the PostScript and PDF transform.

To modify the configuration file for the PDF and PostScript to AFP transform, follow these steps:

1. From the i5/OS command line, enter:  

```
edtf '/QOpenSys/QIBM/ProdData/InfoprintServer/Transforms/ps2afp/ps2afpd.cfg'
```
2. Change the line: `ps_max_memory = 24M` to `ps_max_memory = 99M`.
3. Save and exit the edit session on the file.
4. If Transform Manager is running, from the i5/OS command line enter:  

```
ENDTFMMGR
```
5. Before transforming any PCL, PDF, or PostScript files to AFP, enter:  

```
STRTFMMGR
```

## Starting and Ending Transform Manager

Enter STRTFMMGR on the command prompt to start Transform Manager. This starts the minimum number of each type of transform specified. See “Configuring Transform Manager” on page 162 for information about specifying the minimum number of transforms. You can only run one Transform Manager job at a time. If Transform Manager is already running and you issue this command, the new job is not started. A message is then sent to the job log and the screen.

Enter ENDTFMMGR on the command prompt to end Transform Manager. This command ends all transform jobs started by Transform Manager and ends any active jobs from printer writers.

## Setting Up the Printer Device Description

These transforms are called when a PCL, PDF, or PostScript job is sent to a printer writer that has the transforms enabled. To enable the transforms, the printer device descriptions must be set up correctly. The device must be configured to use AFP data, and must have the image print transform enabled. The image print transform function is enabled automatically when the device has an image configuration object defined. For every writer that will call these transforms, specify these values in the device description:

- AFP(\*YES)
- IMGCFG(\*IMGC $nn$ ),  $nn$  is in the range 01-11.

Transform Manager uses the information from the image configuration object associated with the printer writer to call the appropriate transform. The image configuration objects specify to which type of IPDS printer the transformed data is sent. See Table 12 to determine the appropriate image configuration object.

Table 12. Image Configuration Objects

Image Configuration Object	Dots Per Inch	Edge-to-Edge or No-Print Border	Other
*IMGC01	240	Edge-to-Edge	MMR
*IMGC02	300	Edge-to-Edge	MMR
*IMGC03	600	Edge-to-Edge	MMR
*IMGC04	1200	Edge-to-Edge	MMR
*IMGC05	240	No-Print Border	MMR
*IMGC06	300	No-Print Border	MMR
*IMGC07	600	No-Print Border	MMR
*IMGC08	1200	No-Print Border	MMR
*IMGC09	240	Edge-to-Edge	IM/1 image
*IMGC10	240	No-Print Border	IM/1 image
*IMGC11	240	Edge-to-Edge	CCITT G4 compression

For information about image print transform or image configuration objects, refer to the iSeries Information Center or the Redbook *IBM AS/400® Printing V*. You can obtain Redbooks™ from the Redbooks Web site: <http://www.redbooks.ibm.com/>.

---

## Transforming Data

To use these transforms directly from your i5/OS, release a PCL, PDF, or PostScript job to a printer writer that has the transforms enabled. The printer writer must be properly configured. See “Setting Up the Printer Device Description” on page 166 for information about configuring the printer writer.

You can use these transforms from your personal computer in three ways:

- Send a job on your workstation to a shared PCL, PDF, or PostScript printer. For information about setting up a printer share on the i5/OS, refer to *iSeries Guide to Output*.
- Use LPR to print the data on your i5/OS-attached IPDS printer. When you use LPR, you must submit an appropriate options file with the data, or your output will be incorrect. For information about using LPR and an option file, refer to *TCP/IP Configuration and Reference*. Printing to an IPDS printer requires a license for PSF.
- Call the transforms from an application program by using the Convert Image (QIMGCVTI, QimgCvtImg) API. For information about using this API, refer to the iSeries Information Center.

---

## Deactivating and Reactivating the Transforms

If Infoprint Server is installed on your system and you specified an appropriate image configuration object and AFP(\*YES) in the device description, these transforms are invoked any time you send PCL, PDF, or PostScript data to the device. If you do not want these transforms invoked and do not want to uninstall Infoprint Server, you must delete the exit programs that Infoprint Server registers.

By default, Infoprint Server registers three exit programs to the QIBM\_QIMG\_TRANSFORMS exit point for the PCL, PDF, and PostScript to AFP transforms:

Table 13. Exit Programs Created by Infoprint Server

Exit Program Number	Exit Program	Library
5380	QXTRCLIENT	QIPS
5381	QXTRCLIENT	QIPS
5382	QXTRCLIENT	QIPS

## Steps to Deactivate the Transforms

Follow these steps to deactivate the Infoprint Server PCL, PDF, and PostScript to AFP transforms.

1. On the command line, enter WRKREGINF and press F4. Enter option 8 (work with exit programs) by the QIBM\_QIMG\_TRANSFORMS exit point and press enter:

```

Work with Registration Information
Type options, press Enter.
5=Display exit point 8=Work with exit programs
Exit
Point
Opt Exit Point Format Registered Text
QIBM_AIA_RETR_INF RTVI0100 *YES BRM Services/400 object retri
QIBM_AIA_TAPE_INF MEDI0100 *YES BRM Services/400 media inform
QIBM_AIA_TAPE_MOVE MEDM0100 *YES BRM Services/400 media moveme
QIBM_QCA_CHG_COMMAND CHGC0100 *YES Change command exit programs
QIBM_QCA_RTV_COMMAND RTVC0100 *YES Retrieve command exit program
QIBM_QCQ_AGENT ENDE0100 *YES
QIBM_QCQ_AGENT STRE0100 *YES
QIBM_QGW_NJEOUNBOUND NJEO0100 *YES Network Job Entry outbound ex
QIBM_QHQ_DTAQ DTAQ0100 *YES Original Data Queue Server
8 QIBM_QIMG_TRANSFORMS XFRM0100 *YES
QIBM_QJO_DLT_JRNRCV DRCV0100 *YES Delete Journal Receiver
More...
Command ==>
F3=Exit F4=Prompt F9=Retrieve F12=Cancel

```

- The Work with Exit Programs display opens. Use option 4 (Remove) to remove the three exit programs shown:

```

Work with Exit Programs
Exit point: QIBM_QIMG_TRANSFORMS Format: XFRM0100
Type options, press Enter.
1=Add 4=Remove 5=Display 10=Replace
Exit
Program Exit
Opt Number Program Library
4 5380 QXTRCLIEN QIPS
4 5381 QXTRCLIEN QIPS
4 5382 QXTRCLIEN QIPS
Bottom
Command ==>
F3=Exit F4=Prompt F5=Refresh F9=Retrieve F12=Cancel

```

## Reactivating the Transforms

To reactivate the PCL, PDF, and PostScript to AFP transforms, you must re-register the exit programs by entering these commands.

**Important:** Each part of the program data (PGMDTA) must be eight bytes long. For example, for PCL to AFP exit program, the program data is 'PCL+5 spaces+AFPDS+3 spaces'.

```

ADDEXITPGM EXITPNT(QIBM_QIMG_TRANSFORMS) FORMAT(XFRM0100) PGMNBR(5380)
PGM (QIPS/QXTRCLIEN) THDSAFE(*NO) MLTTHDACN(*MSG)
TEXT('IBM InfoprintServer PCL, PDF and PS TO AFP')
CRTEXITPNT(*YES) PGMDTA(37 16 'PCL AFPDS ')
ADDEXITPGM EXITPNT(QIBM_QIMG_TRANSFORMS) FORMAT(XFRM0100) PGMNBR(5381)
PGM (QIPS/QXTRCLIEN) THDSAFE(*NO) MLTTHDACN(*MSG)
TEXT('IBM InfoprintServer PCL, PDF and PS TO AFP')
CRTEXITPNT(*YES) PGMDTA(37 16 'PS AFPDS ')
ADDEXITPGM EXITPNT(QIBM_QIMG_TRANSFORMS) FORMAT(XFRM0100) PGMNBR(5382)
PGM (QIPS/QXTRCLIEN) THDSAFE(*NO) MLTTHDACN(*MSG)
TEXT('IBM InfoprintServer PCL, PDF and PS TO AFP')
CRTEXITPNT(*YES) PGMDTA(37 16 'PDF AFPDS ')

```

## Font Downloader

Infoprint Server Font Downloader (hereafter referred to as Font Downloader) lets you use certain double-byte fonts with the PostScript to AFP transform. These fonts are downloaded from a Mac to your PC with one of these client products: IBM Infoprint Manager for Windows (Program Number 5639-N49), Infoprint DBCS Font Downloader feature (LCD4-5884-00) or IBM Infoprint Manager for AIX (Program Number 5765-E42), Infoprint DBCS Font Downloader feature (LCD4-5884-00). Font Downloader then uploads the fonts to your i5/OS. Hereafter, the client products are referred to as Infoprint DBCS Font Downloader client.

When a Font Downloader job is started, it listens at a specified port for a connection from an Infoprint DBCS Font Downloader client application. When a new font is received, the Font Downloader job puts the font in the correct directory. It then modifies the font mapping table and sets up symbolic links to the downloaded font directory. This is illustrated in Figure 53.

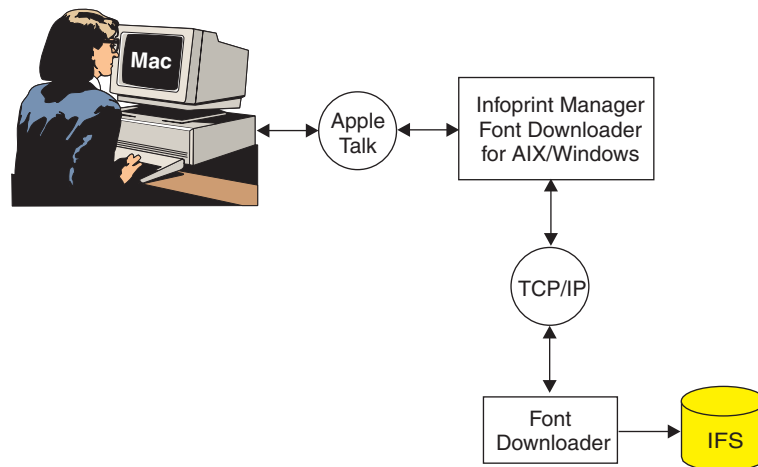

Figure 53. Font Downloader Process

**Security Note:** As shown in Figure 53, Font Downloader opens an iSeries TCP/IP port. No user authentication is required to connect to this port. For this reason, two additional security features have been added. First, the iSeries font installation job that is started by STRFN TDWN has a time-out feature. By default, the job ends and the TCP/IP port is closed after 20 minutes. Second, the font installation job runs under the QIP SJOB profile. QIP SJOB owns all fonts installed on the iSeries server.

## Syntax

Figure 54 on page 170 shows the command syntax used to start Font Downloader.

## Start Font Downloader

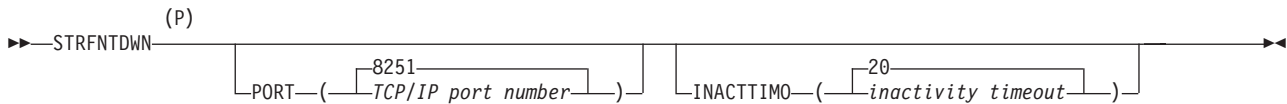

### Notes:

P All parameters preceding this point can be specified in positional form.

Figure 54. Starting Font Downloader

Figure 55 shows the command syntax used to end Font Downloader.

## End Font Downloader



Figure 55. Ending Font Downloader

## Parameters

You can use the following parameters to customize the Start Font Downloader command.

### PORT

Specifies on which TCP/IP port the Font Downloader job should listen for Infoprint DBCS Font Downloader client connections. You will get an error if you try to start Font Downloader on a port that is already being used. Therefore, you should avoid using commonly used port numbers.

**8251** Font Downloader listens on port 8251.

*TCP/IP-port-number*

Font Downloader listens on the specified port number.

### INACTTIMO

Specifies how long (in minutes) the Font Downloader job is inactive before ending.

**20** Font Downloader ends if there is no activity between Font Downloader and the Infoprint DBCS Font Downloader client for 20 minutes.

*inactivity-timeout*

Font Downloader ends if there is no activity between Font Downloader and the Infoprint DBCS Font Downloader client for the specified number of minutes. Specify a value in the range 1-9999 minutes.

## Examples

The following command starts a Font Downloader job if one is not already running. The job listens on port 6001 for requests from the Infoprint DBCS Font Downloader client. If no requests are received from the client in ten minutes, the Font Downloader job is ended.

```
STRFNTDWN PORT(6001) INACTTIMO(10)
```

The following command ends a Font Downloader job if one is running.

```
ENDFNTDWN
```



## Troubleshooting

This section describes some common errors, what could cause them, and possible ways fix them.

Table 14. Troubleshooting the Transforms Managed by Transform Manager

Problem	Possible Cause	Possible Solutions
The spooled file stays in PND status.	There are no available transforms to process the request. Either many requests are queued or a very large job is being transformed. One or more transforms might have ended abnormally or might be hung.	In the configuration file, increase the minimum active, the maximum active value, or both, then issue ENDTFMMGR followed by STRTFMMGR.
The spooled file cannot be printed and error CPC $nnnn$ is issued.	The exit point registration information is incorrect or corrupted.	Replace the existing information with the correct values. See Appendix D, "Exit Points," on page 217 for instructions about viewing and changing exit point QIBM_QIMG_TRANSFORMS information.
Transform Manager does not start.	Your system does not meet the minimum requirements.	Ensure that your system meets the minimum requirements to run Transform Manager. See "System Requirements" on page 161.
	You do not have authority to issue the command.	Ensure that you have *JOBCTL special authority.
	The configuration file is incorrect.	Correct the configuration file <b>qxtrtfmmgr.cfg</b> . See "Configuring Transform Manager" on page 162 for the proper format.
	The <b>fonts.map</b> file contains an entry that does not exist.	Check all of the <b>fonts.map</b> entries. See "Customizing the PostScript to AFP and PDF to AFP Transforms" on page 164.
Document prints with wrong orientation	The wrong paper size is specified in the printer file.	Correct the printer file. Do not use paper size to specify orientation; this information is contained in the data. For example, to print a document on 11 X 17 paper in landscape orientation, specify 11 X 17 paper, not 17 X 11.
A PDF file does not transform correctly. The print request produces error pages that report problems with the pdfprint function and returns a PostScript error page.	The PDF file requires more memory to transform.	Increase the maximum memory setting for the PDF to AFP transform. See "Increasing the Maximum Memory Setting" on page 165 for instructions.



---

## Chapter 8. Related Products

This chapter describes these products that are related to Infoprint Server:

- “iSeries Access”
- “iSeries Access for Web”
- “Infoprint Designer for iSeries” on page 174

---

### iSeries Access

This section describes what iSeries Access is and how to obtain it. For instructions to complete tasks related to Infoprint Server, refer to *iSeries Guide to Output*, the iSeries Information Center, or the iSeries Navigator online help.

#### Overview

iSeries Access is IBM’s Windows client for connectivity to the iSeries. It is a separately orderable program (Program Number 5722-XE1).

Unless otherwise noted, iSeries Access refers to both Client Access Express and iSeries Access.

You can use iSeries Access to accomplish a wide variety of tasks including these:

- Print data generated from a user’s PC application on an IPDS printer - uses iSeries Navigator.
- Create PC resources as resources on the i5/OS- uses iSeries Navigator.
- Create or change a PSF configuration object - uses iSeries Navigator.
- Access the PDF subsystem - uses iSeries Navigator. This lets you convert a spooled file to PDF then send it as e-mail, store it in the integrated file system, or re-spool it. See “Accessing the PDF Subsystem with iSeries Access” on page 67 for instructions.
- Run any i5/OS command - uses iSeries Navigator.
- View AFP files - uses AFP Viewer.

For information about iSeries Access, refer to this Web page:  
<http://www.ibm.com/servers/eserver/iseries/access/>.

---

### iSeries Access for Web

iSeries Access for Web (Program Number 5722-XH2) gives you access to your iSeries from a Web browser such as Netscape, Opera, or Internet Explorer. This product runs on Windows, Linux, and AIX systems. However, all of the necessary code is on the iSeries server, so you do not have to install anything on the client. iSeries Access for Web lets you complete these tasks and more:

- View and control printers, internet printers, printer shares, spooled files (view as GIF, TIFF, PCL, or AFP with AFP viewer), and output queues.
- Display or send i5/OS messages, view message queues.
- Access the i5/OS file system and file shares.
- Run CL commands with prompt support.

- View spooled files in PDF. This uses Infoprint Server if it is installed. If not, the file is transformed to TIFF, which is then converted to PNG and embedded in a PDF document. For instructions, refer to *iSeries Guide to Output*.
- Copy, delete, and rename files.

For information about iSeries Access for Web, refer to this Web page:

<http://www.ibm.com/servers/eserver/series/access/web/>.

---

## Infoprint Designer for iSeries

Infoprint Designer for iSeries (Program Number 5733-ID1) is available for OS/400 4.5 or higher. Infoprint Designer provides a new way for you to format your data and create AFP overlays and page segments. It has a true WYSIWYG (what you see is what you get) interface. This lets you see exactly how the formatted application will look while you work on it. The package includes overlay creation and data layout functions that are closely integrated, plus a separate Image Editor program for producing and editing page segments.

For more information about Infoprint Designer, refer to these:

- The Infoprint Designer Web page:  
[http://www.printers.ibm.com/internet/wwsites.nsf/vwwebpublished/ipdesignerhome\\_i\\_ww](http://www.printers.ibm.com/internet/wwsites.nsf/vwwebpublished/ipdesignerhome_i_ww)
- *Infoprint Designer for iSeries: Getting Started*
- The Redbook *IBM @server iSeries Printing VI: Delivering the Output of e-business*

---

## Appendix A. Related Tasks

---

### Turning a PC AFP Resource into an i5/OS Resource

You can turn an AFP resource (page segment or overlay) on your PC into an AFP resource on your i5/OS without iSeries Access by following these steps.

1. Make sure that the PC AFP resource is in `\\system\QDLS\mydir`, where *system* is the name of your i5/OS and *mydir* is a directory in QDLS. If the AFP resource is not in that path, map a network drive to your i5/OS system then use Windows Explorer to move the file. To map a network drive, follow these steps:
  - a. Ensure that QDLS is shared. You can only map a drive to a shared directory. If it is not shared, contact your system administrator to set it up as a share. Alternatively, if Root is shared, you can map a drive to QDLS through Root.
  - b. Right-click My Network Places and select **Map network drive...**
  - c. In the Map Network Drive window, specify these values, then select **Finish**:
    - Accept the default drive letter.
    - For **Folder**, specify `\\system\QDLS\mydir`. If QDLS is not shared and Root is, specify `\\system\root\QDLS\mydir`.
    - Deselect **Reconnect at login**.

**Note:** These steps are written for a Windows 2000 system. These steps might vary slightly, depending on the version of Windows you are running.

2. On your i5/OS system, create a physical file. You will copy the resource into this physical file.
  - Specify `CRTPF FILE(library/file_name) RCDLEN(8201)` on the command line. *file\_name* and *library* are the name of the new physical file and the library you want it created in, respectively.
3. Copy the Windows AFP resource into this new physical file:
  - Specify `CPYFRMPCD FROMFLR(folder) TOFILE(library/file_name) FROMDOC(resource_name) TRNTBL(*NONE)` on the command line. *folder* specifies the name of a folder or folder path containing the PC resource that is copied. *file\_name* and *library* are the same values you specified in step 2 and *resource\_name* is the name of the PC AFP resource.
4. Create an i5/OS object from the physical file:
  - To create a page segment, specify `CRTPAGSEG PAGSEG(pageseg_library/pageseg_name) FILE(library/file_name) MBR(file_name)` on the command line. *Pageseg\_name* and *pageseg\_library* specify the name and library of the page segment that is created.
  - To create an overlay, specify `CRTOVL OVL(ovl_library/ovl_name) FILE(library/file_name) MBR(file_name)` on the command line. *Ovl\_name* and *ovl\_library* specify the name and library of the overlay that is created.
  - In the above, *file\_name* and *library* are the same values you specified in step 1.

For instructions about using iSeries Access to do this, refer to *iSeries Guide to Output*.



---

## Appendix B. Mapping Program

The mapping program is an exit program that lets you customize the PDF subsystem. It lets you map a routing tag, such as a customer number, to one or more e-mail addresses or other information, such as commands to run. If you have an input spooled file that will be segmented into multiple files, you can use a mapping program, to specify intelligent routing of the output files. That is, you can specify unique routing options for each segment, depending on the routing tag.

You can also use the mapping program to specify the PDF file's name, AFP respooling, the directory to store the PDF file in, and when e-mailing, encryption of PDF files, the subject text, and text to include at the beginning of each e-mail. If you use an SMTP server to send the e-mail, you can also use the mapping program to specify carbon copy (cc), blind carbon copy (bcc), and reply-to addresses, a file to use as the e-mail body, and attachments.

When you print to a device specified as AFP(\*YES) and that calls for a PSF configuration object that specifies any value other than \*NONE for PDFGEN, you can specify a mapping program. If specified, the mapping program is called for each successfully generated output file after PSF receives notification from the virtual printer that all pages have been stacked. The mapping program then resolves the routing tags before mailing the file. It does not check the format of the routing tag, but tries to map each tag.

**Note:** Multiple calls might be made to the mapping program for each segment or file that is converted to PDF. For instance, if you have specified to e-mail a segment or file, the mapping program will be called before the file is converted to PDF, to let you specify encryption values for the PDF files. In that call to the mapping program, the "path and name of the PDF file" in the input to the mapping program will be blank. In the final call to the mapping program, after the file or segment has been converted to PDF "path and name of the PDF file" will be set.

A sample mapping program is available in Appendix C, "Templates," on page 209.

Infoprint Server provides a data queue where notifications of PDF transform completion can be stored. Your mapping program can use the Receive Data Queue API (QRCVDTAQ) to access this information. For more information about the data queue, see "PDF Conversion Completion Data Queue" on page 95. For information about using APIs, go to the iSeries Information Center.

The mapping program uses QSPLJOB's library list. If you want the mapping program to find a file that is not in a library in QSPLJOB's library list, add the appropriate library to the library list.

This appendix contains this information:

- "Changes to the PDF Mapping Program" on page 178
- "Dependencies Between Mapping Program Values and PSF Configuration Object Values" on page 179
- "Parameters" on page 179
- "Troubleshooting the PDF Mapping Program" on page 198

The following sections describe various fields and formats that can be used in the mapping program. However, not all fields can be used when PSF uses the SNADS protocol to send your e-mail. PSF uses the SNADS protocol when PDFMAILSVR(\*SNDDST) is specified. The fields that can be used with SNADS are marked in Table 15. The fields that require an SMTP server also say so in their description. All fields can be used when an SMTP mail server is specified in PDFMAILSVR.

*Table 15. E-mail-Related Fields that Can be Used with SNADS*

<b>Field Name</b>	<b>Where used</b>
All fields	PDF encryption format
Disposition of PDF e-mail	Mapping Program Output Information parameter
Disposition of PDF Error	Mapping Program Output Information parameter
E-mail address	Mapping Program Output Information parameter
Form type	Mapping Program Input Information parameter
Length of e-mail address	Mapping Program Output Information parameter
Length of Extension area format	Extension area format
Length of file name for e-mailed PDF attachment	Extension area format
Length of message text	Mapping Program Output Information parameter
Length of subject	Extension area format
Message text data	Mapping Program Output Information parameter
More processing	Mapping Program Output Information parameter
Offset to extension area	Mapping Program Output Information parameter
Offset to file name for e-mailed PDF attachment	Extension area format
Offset to subject	Extension Area format
PDF map object name	Mapping Program Input Information parameter
PDF map object library	Mapping Program Input Information parameter

---

## Changes to the PDF Mapping Program

Mail sender is a new field in the “Extension Area Format” on page 185. If you use this field, the value for Length of Extension area format must be 110.



---

## Dependencies Between Mapping Program Values and PSF Configuration Object Values

Some mapping program values require specific settings in the PSF configuration object. For example, if you specify \*PSFCFG for Name of output queue on which to spool PDF, the output queue must be specified in the PSF configuration object. However, in order to specify the output queue, you must specify PDFGEN(\*SPLF) on the PSF configuration object. That precludes you from specifying the PDF mail server, so you cannot specify an SMTP server, such as \*LOCAL. An SMTP server is required for many PDF routing functions. Table 16 lists the PSF configuration object dependencies. For any parameters not in this table, you can use F9 to specify the value when you don't see it as a valid parameter. For example, if you specify PDFGEN(\*SPLF), you can press F9 to specify the mapping program on the PDF user program parameter.

Table 16. Dependencies Between Mapping Program Values and PSF Configuration Object Values

If you want to specify this in the mapping program:	You must first specify this in the PSF configuration object:
PDF mail server name (PDFMAILSVR)	PDFGEN(*MAIL)
Sender of electronic mail (PDFSENDER)	PDFGEN(*MAIL)
PDF output queue (PDFOUTQ)	PDFGEN(*SPLF)
PDF directory (PDFDIR)	PDFGEN(*STMF)

---

## Parameters

This section describes the mapping program input and output parameters. Table 17 lists the required parameters for the mapping program.

Table 17. Required Parameter Group

Parameter	Input/Output	Type
Mapping program input information	Input	Char(*)
Length of input information	Input	Binary(4)
Mapping program output information	Output	Char(*)
Length of output information buffer	Input	Binary(4)
Length of output information available	Output	Binary(4)

### Length of input information

The length of the input information.

### Length of output information available

You set this value to signify you have more data than will fit in the **length of output information buffer**. This will be the actual size you need to fit all your data into. If the **length of output information available** is larger than the output information buffer, the mapping program is automatically called again with a new buffer size. If this length is less than or equal to the length of the routing tag output information, all available information has been returned. If this length is greater than the length of the routing tag output information, data beyond the length is truncated. Only data up to the length provided is returned in the e-mail exit output information buffer. The **length of output information buffer** specifies the maximum amount of data that can be returned by the user.

### Length of output information buffer

The size, in bytes, of the routing tag output information buffer. This field is the length of the buffer that you have to contain your data. If it is not large enough to contain all the data, use the **length of output information available** field to tell PSF how large of a buffer you need. Then PSF will call the mapping program again with the enlarged buffer size. See “PDF Mapping Program in C” on page 209 or “PDF Mapping Program in RPG” on page 212 for an example.

### Mapping program input information

The mapping program information that is input to the mapping program from the PSF print writer. For the format description of the information, see Table 18.

### Mapping program output information

The mapping program information which is output from the mapping program to the PSF print writer. For the format description of the information, see Table 19 on page 182.

## Mapping Program Input information

Table 18 shows the structure for the e-mail input information. This structure contains the mapping program information that is input to the mapping program from the PSF print writer. This structure was formerly called “E-mail input information”.

Table 18. Mapping Program Input Information Structure

Decimal Offset	Hex Offset	Type	Description
0	0	CHAR(26)	Qualified job name
26	1A	CHAR(10)	Spooled file name
36	24	BINARY(4)	Spooled file number
40	28	CHAR(250)	Routing tag
290	122	CHAR(340)	Path and name of PDF file
630	276	CHAR(1)	Mail server type
631	26C	CHAR(1)	Reserved
632	26E	BINARY(4)	Path and name CCSID
636	272	CHAR(10)	Mail sender
646	27C	CHAR(10)	User data (USRDTA)
656	290	CHAR(8)	Job system name
664	298	CHAR(8)	Creation time stamp
672	2A0	CHAR(10)	Output queue on which the spooled file is located
682	2AA	CHAR(10)	Output queue library
692	2B4	CHAR(10)	PDF map object name
702	2BE	CHAR(10)	PDF map object library
712	C8	CHAR(10)	Formtype

A more detailed description of each entry in the table follows in alphabetical order according to Description:

**Creation time stamp**

Identifies the date and time when the spooled file was created. See the QWCCVTD T API and format \*DTS for more information.

**Formtype**

The value from the FORMTYPE parameter on the spooled file.

**Job system name**

Identifies the name of the system on which the spooled file was created.

**Mail sender**

Identifies the sender of the e-mail. This value is specified on the spooled file or printer file USRDFN DTA parameter or on the PSF configuration object PDFSENDER parameter. If the value is specified in all three places, the value that is specified on spooled file attributes is used. If no mail sender is identified on USRDFN DTA, the value from the PDFSENDER parameter of the PSF configuration object is used.

**Mail server type**

Identifies the mail server to use. Values are:

'1' Use the Send Distribution (SNDDST) command.

'2' Use the SMTP protocol to send e-mail.

**Output queue library**

Identifies the library where the output queue is located.

**Output queue on which the spooled file is located**

Identifies the output queue to which the writer has been started.

**Path and name CCSID**

The CCSID of the path and name of the PDF file.

**Path and name of the PDF file**

Identifies the path and name of the PDF file.

**PDF map object library**

The library where the map object resides, if one was specified on the PSF configuration object. Valid values are:

**X'40' (blank)**

No value was specified on the PDFMAPBOBJ parameter of the PSF configuration object.

*map object library*

The library where the map object resides.

**PDF map object name**

The library where the map object resides, if one was specified on the PSF configuration object. Valid values are:

**X'40' (blank)**

No value was specified on the PDFMAPBOBJ parameter of the PSF configuration object.

*map object*

The map object to use with the IBM-supplied mapping program.

**Qualified job name**

Identifies the qualified job name of the job that created the spooled file that was converted to PDF. The 26 characters are specified as follows:

**CHAR(10)**

Job name

**CHAR(10)**  
User name

**CHAR(6)**  
Job number

**Routing tag**

Identifies the mail address or routing tag specified on the spooled file or printer file USRDFNDTA parameter or the group tag in the data. This should be blanks (X'40') if no value was provided by either parameter. If both provide tag or address information, the group tag takes precedence.

The mapping program can return mail addresses based on any value in the input structure to the mapping program. For example, job, file, and user data information.

**Spooled file name**

Identifies the name of the spooled file that was converted to PDF.

**Spooled file number**

Identifies the unique number of the spooled file that was converted to PDF.

**User data**

The value in the printer file USRDTA parameter. This contains blanks if USRDTA contains blanks.

## Mapping Program Output

This section describes the output for the mapping program. Table 19 shows the structure for the e-mail output format. Note that each byte of any reserved field in the e-mail output structure must be initialized to X'00'. This format was formerly called "E-mail output".

*Table 19. Mapping Program Output Information Structure*

Decimal Offset	Hex Offset	Type	Description
0	0	CHAR(1)	Disposition of PDF e-mail
1	1	CHAR(1)	More processing
2	2	CHAR(2)	Reserved (set each byte to X'00')
4	4	BINARY(4)	Length of message text (0 - 255 bytes)
8	8	BINARY(4)	Length of mail address (0 - 16,000,000)
12	C	CHAR(255)	Message text
267	10B	CHAR(1)	Reserved (set to X'00')
268	10C	BINARY(4)	Offset to extension area
272	110	BINARY(4)	CCSID of message text and subject
276	114	CHAR(1)	Disposition of PDF Stream file
277	115	CHAR(1)	Disposition of PDF Spooled file
278	116	CHAR(1)	Disposition of PDF Error
279	117	CHAR(1)	Disposition of AFPDS Spooled file
280	118	BINARY(4)	Offset to message text data
284	122	CHAR(3)	Reserved (set each byte to X'00')
287	11F	CHAR(*)	E-mail address

A more detailed description of each entry in the table follows in alphabetical order according to Description:

#### **CCSID of message text and subject**

The CCSID associated with the message text and subject, if specified. This CCSID is used to convert the message text and subject to Unicode before they are placed in the e-mail. The e-mail receiver's e-mail program might have to be configured for the appropriate character set in order to view the e-mail correctly.

This field is only used when an SMTP mail server is specified in your PSF configuration object. If you are not using an SMTP mail server, set this field to 0. Valid values are:

0 Use the job's default CCSID.

*ccsid-value*

Specifies the CCSID. Values are in the range 1-65533.

#### **Disposition of AFPDS spooled file**

Specifies whether the input to the PDF subsystem should be respooled as AFP data. If a file is to be spooled as AFP, you must specify an output queue. You can specify it on the PSF configuration object or in the "Spooled File AFPDS Distribution Format" on page 194 on the **Output queue name** field. Valid values are:

'0' Do not respool the file as AFP.

'1' Respool the file as AFP.

#### **Disposition of PDF error**

This field is used to indicate whether PSF should continue processing the current spooled file or segment. Valid values are:

'0' Continue processing. PSF will examine the following fields to determine if any further action should be taken with the current spooled file or segment:

- Disposition of PDF e-mail
- Disposition of PDF Stream file
- Disposition of PDF Spooled file
- Disposition of AFPDS Spooled file

'1' Do not continue processing. PSF stops processing the current spooled file or segment and issues message PQT4140 with reason code 15. For more information about this message, see "PDF Mapping Program Reason Codes" on page 198. If there is an address specified for PDF administrator, the following also occurs:

- An e-mail is sent to this address with the PDF file attached, if possible.
- If a segment is being processed, processing stops for the current segment. PSF processes any remaining segments. After all the segments have been processed, the spooled file is placed on hold.
- If a non-segmented spooled file is being processed, the spooled file is held.

If there is no address specified for PDF administrator, the spooled file is held and no further processing is done.

### Disposition of PDF e-mail

Specifies whether to e-mail the PDF file. This was previously named **Disposition of PDF file**. Valid values are:

- '0' Do not e-mail the PDF file
- '1' E-mail the PDF file to specified addresses.

### Disposition of PDF spooled file

Specifies whether to spool the PDF file. Valid values are:

- '0' Do not spool the PDF file.
- '1' Spool the PDF file to an output queue. You must also specify an output queue. Specify it on the PSF configuration object's PDF output queue (PDFOUTQ) parameter or with the "Spooled File PDF Distribution Format" on page 193 in the **Output queue name** field.

### Disposition of PDF stream file

Specifies whether the PDF should be stored as a stream file in the integrated file system. Valid values are:

- '0' Do not store the PDF as a stream file.
- '1' Store the PDF as a stream file. You must also specify the path in which to store the file. You can specify it on the PSF configuration object PDF directory (PDFDIR) parameter. Alternatively, you can specify it using the **Offset to PDF path name** and **Length of PDF path name** fields of the "Extension Area Format" on page 185. If you want to specify the path on the PSF configuration object, set **Offset to PDF path name** and **Length of PDF path name** to 0.

### E-mail addresses

The e-mail addresses (in the form *name@domain*) to which the PDF file is sent. If you specify more than one address, they must be delimited by single quotation marks, for example, ('name1@domain1' 'name2@domain2')

### Length of e-mail address

The length of the e-mail address data to send the PDF file to. The maximum length allowed is 16MB because this is the largest value that can be used to allocate a user space. If the PDF file should not be e-mailed, set the length of the e-mail address data to zero. The initial amount of space that is allowed for e-mail addresses is 49 bytes. If you need more space than that, use the mapping program to extend the size. *Infoprint Server for iSeries: User's Guide* gives an example of this situation.

### Length of message text

The length of the message text to be used in the body of the e-mail. Values can be in the range 0-255. If no message text is to be used when sending the PDF file, set the length of the message text data to zero.

### Message text

The message text data to be used in the body of the e-mail when sending the PDF file. This value should be blanks if the text length is zero.

You can specify message text and files for the body of the e-mail. If you do not specify message text or a file to be used for the body of the e-mail, the default text is used. The default text is obtained from message PQT4133 in message file QPQMSGF.

PSF skips a line after the message text. Two end-of-line characters are written after your data. Any files specified for inclusion in the body of the e-mail are positioned at this point.

If you specify an SMTP mail server, the message text and subject's CCSID is used to convert the data to Unicode before adding it to the e-mail. The e-mail receiver's e-mail program might have to be configured for the appropriate character set in order to view the e-mail correctly.

### More processing

Specifies whether the mapping program should be called again to do more processing for the same spooled file.

#### '0' (X'F0')

Do not call the mapping program again. This field occupies the offset of a field that was reserved in Infoprint Server 5.1. Therefore, X'00' is treated the same as 0 (X'F0') for compatibility.

#### '1' (X'F1')

Call the mapping program again. The input information presented to the mapping program is not modified. If an error occurs while processing an e-mail, the spooled file is held and the mapping program is not called again, regardless of this field.

### Offset to extension area

Offset from the beginning of this structure. The value must be a 4-byte multiple. A value of 0 indicates that the extension area is not being used. See "Extension Area Format" for details about the extension area.

### Offset to message text data

Offset from the beginning of this structure. The value must be a 4-byte multiple. Use this field if you specify more than 255 bytes of message text data. If you are using the **Message text data** field, specify a value of 0 for **Offset to message text data**.

## Extension Area Format

Use this format when you want to specify encryption for the output PDF file, name the PDF output file, or use intelligent routing. If your application has no need for it, specify a value of 0 for Offset to extension area in the e-mail exit program output information.

This format must begin on a 4-byte multiple. All offsets are computed from the beginning of the PDF Mapping Program Output Information structure.

Table 20. Extension Area Format

Decimal Offset	Hex Offset	Type	Description
0	0	BINARY(4)	Length of Extension area format
4	4	BINARY(4)	Offset to subject
8	8	BINARY(4)	Length of subject
12	C	BINARY(4)	Offset to ReplyTo e-mail address
16	10	BINARY(4)	Length of ReplyTo e-mail address
20	14	BINARY(4)	Offset to CC e-mail address
24	18	BINARY(4)	Length of CC e-mail address
28	1C	BINARY(4)	Offset to BCC e-mail address
32	20	BINARY(4)	Length of BCC e-mail address
36	24	BINARY(4)	Offset to list of path names for body of e-mail

Table 20. Extension Area Format (continued)

Decimal Offset	Hex Offset	Type	Description
40	28	BINARY(4)	Offset to path name for directory for files
44	2C	BINARY(4)	Length of path name for directory for files
48	30	BINARY(4)	Offset to list of path names of attachments
52	34	BINARY(4)	Offset to PDF stream file path and file name
56	38	BINARY(4)	Length of PDF stream file path and file name
60	3C	BINARY(4)	Offset to PDF file name for e-mail
64	40	BINARY(4)	Length of PDF file name for e-mail
68	44	BINARY(4)	Offset to PDF file public authority
72	48	BINARY(4)	Length of PDF file public authority
76	4C	BINARY(4)	Offset to spooled file PDF distribution
80	50	BINARY(4)	Length of spooled file PDF distribution
84	54	BINARY(4)	Offset to spooled file AFP distribution
88	58	BINARY(4)	Length of spooled file AFP distribution
92	5C	BINARY(4)	Offset to PDF encryption information
96	60	BINARY(4)	Length of PDF encryption information
100	64	CHAR(10)	Mail sender

A more detailed description of each entry in the table follows in alphabetical order according to Description:

**Length of BCC e-mail address**

Specifies the length of the BCC e-mail address to send the e-mail to. This field is only used when an SMTP mail server is specified in your PSF configuration object. If an SMTP mail server is not specified, set this field to 0.

**Length of CC e-mail address**

Specifies the length of the CC e-mail address to send the e-mail to. This field is only used when an SMTP mail server is specified in your PSF configuration object. If an SMTP mail server is not specified, set this field to 0.

**Length of Extension area format**

Specifies the length of the Extension area format. Specify one of these values:

**52** The original mapping program length. You cannot use any fields added in 5.3 or later releases of the operating system.

**100** Specify this value to use any fields except Mail sender.

**110** Specify this value if you want to use the Mail sender field.

**Length of path name for directory for files**

Specifies the length of the path name containing the directory in which files to attach to the e-mail can be stored.



The mapping program uses QSPLJOB's library list. If you want the mapping program to find a file that is not in a library in QSPLJOB's library list, add the appropriate library to the library list. This field is only used when an SMTP mail server is specified in your PSF configuration object. If an SMTP mail server is not specified, set this field to 0.

**Length of PDF encryption information**

The length of the PDF file encryption information. This field is only used when an SMTP mail server is specified in your PSF configuration object. If an SMTP mail server is not specified, set this field to 0.

**Length of file name for PDF attachment for e-mail**

The length of the PDF file name for the e-mail attachment. If you are not specifying a PDF file name, set this field to 0. If you are using SNDDST to send the e-mail, the file name cannot be longer than 12 characters.

**Length of PDF file public authority**

The length of public authority to the PDF file. This field is used only when the PDF file is to be stored as a stream file. That is, when **Disposition of PDF stream file** in "Mapping Program Output" on page 182 is set to '1'. If the PDF file is not being stored as a stream file, set this field to 0.

**Length of PDF stream file path and file name**

The length of the path where the PDF stream file will be stored plus the PDF file name. It is recommended that you create all the directories specified for the stream file path. PSF will only create these if QSPLJOB has write authority to the appropriate directories. This field is used only when **Disposition of PDF stream file** in "Mapping Program Output" on page 182 is set to '1'. If the PDF file is not being stored as a stream file, set this field to 0.

**Length of spooled file AFP distribution**

The length of the AFP spooled file distribution information. This field is used only when you specify additional spooled file information in "Spooled File AFPDS Distribution Format" on page 194; otherwise, it must be set to zero.

**Length of spooled file PDF distribution**

The length of the PDF spooled file distribution information. This field is used only when you specify additional spooled file information in "Spooled File PDF Distribution Format" on page 193; otherwise, it must be set to zero.

**Length of ReplyTo e-mail address**

Specifies the length of the reply to e-mail address. If you specify this address, it is sent any non-delivery messages for incorrect e-mail addresses. This field is only used when an SMTP mail server is specified in your PSF configuration object. If an SMTP mail server is not specified, set this field to 0.

**Length of subject**

Specifies the length of the character string to be used as the subject text. The maximum length is 255 if you are using an SMTP mail server. The maximum length if you are using the SNDDST command is 44. Data exceeding the maximum length is truncated. If there is no subject, set this field to 0. If you do not specify subject text, default text is used.

**Mail sender**

The name of the mail sender. This name must be a valid user profile enrolled in the System Distribution Directory. If your PSF configuration object specifies PDFMAILSVR(mail-server-name) or PDFMAILSVR(\*LOCAL), the user profile must have an SMTP user ID and SMTP domain specified in the System Distribution Directory.

If you want to use the mail sender that is specified in the PSF configuration object, specify all blanks (X'40') for this value. If you specify a value for Mail sender in this exit program and also in the PSF configuration object, the value in the PSF configuration object is ignored.

Use Display Directory Entries (DSPDIRE) to view the entry in the System Distribution Directory. For information about working with the System Distribution Directory, see "Enabling Your i5/OS to Send E-Mail" on page 150. For instructions about specifying an SMTP address on a System Distribution Directory entry, see step 7 in "Steps to Enable Your i5/OS to Send E-mail" on page 151.

#### **Offset to BCC e-mail address**

Specifies the offset to the BCC e-mail addresses. This area contains the BCC e-mail addresses to which the PDF file is sent. The addresses must be delimited by single quotation marks. For example, ('name1@domain1' 'name2@domain2') Specify 0 if you do not want the e-mail sent to any BCC addresses.

#### **Offset to CC e-mail address**

Specifies the offset to the CC e-mail addresses. This area contains the CC e-mail addresses to which the PDF file is sent. The addresses must be delimited by single quotation marks. For example, ('name1@domain1' 'name2@domain2') Specify 0 if you do not want the e-mail sent to any CC addresses.

#### **Offset to file name for PDF attachment for e-mail**

The offset to the file name for e-mailed PDF files. Do not use this field to specify the file's location, only the name and, optionally, extension, for example, myfile.pdf. Infoprint Server does not add a file extension. IBM recommends using a lower-case extension for compatibility with other operating systems. If you are using SNDDST to send the e-mail, the file name cannot be longer than 12 characters; eight characters for the name and four for the optional ".pdf" extension. To have PSF give the PDF file the default name, specify 0.

#### **Offset to list of path names for body of e-mail**

Specifies the offset to the list of path names for the files to include in the body of the e-mail. You can specify one or more files to include, but the files must be in the integrated file system. If you include the PDF file you are sending in this list, it is attached again. This field is only used when an SMTP mail server is specified in your PSF configuration object. If an SMTP mail server is not specified, set this field to 0.

The CCSID of the file is used if a code page conversion is required. Refer to *Infoprint Server for iSeries: User's Guide* for information about the format to use when specifying this data.

#### **Notes:**

1. The order in which you list these files is the order in which they are included in the e-mail. These files are included after the message text, if specified.
2. You must specify a threadsafe file system. PSF can only access threadsafe file systems. These file systems are not threadsafe:
  - QNetware
  - QFileSvr.400
  - Network File System (NFS)
  - QDLS

3. All files must be encoded in a CCSID that matches the CCSID of the target system. For example, if you are using a file that contains the Euro symbol in CCSID 923, ensure that the receiving system uses CCSID 923.
4. Typically, if a file is not text (file type .txt) or HTML (file type .htm or .html), it is included as an attachment to the e-mail. For example, if you specify a sound file to be part of the e-mail body, it is attached to the e-mail instead. However, JPEG files specified as body files might be opened in the body, depending on the e-mail program.
5. If this file is to be used with the **Path name for directory for files**, the file name is appended to the **Path name for directory for files**. Do not use a "/" as the first character when specifying the file name. However, the file can be nested within another directory, for example, mySubDirectory/myFile.txt.
6. If this file is not to be used with the **Path name for directory for files**, the file name must be fully-qualified, beginning with a "/".

#### **Offset to list of path names of attachments**

Specifies the offset to the list of path names for the files to attach to the e-mail. You can specify one or more files to attach, but the files must be in the integrated file system. Do not include the original PDF file in this list unless you want the file to be attached twice. Specify 0 if you do not want any files (other than the original PDF file) attached. This field is only used when an SMTP mail server is specified in your PSF configuration object. If an SMTP mail server is not specified, set this field to 0.

If you specified a directory to be used for files (see **Offset to path name for directory for files**), the path name specified for this field is appended to that directory. When you specify a '1' for the file in **Use specified directory** parameter in the Individual Stream File Information format. If you did not specify a directory to be used for files, the path name specified for each attachment must be fully resolved.

Refer to *Infoprint Server for iSeries: User's Guide* for information about the format to use when specifying this data.

#### **Notes:**

1. You must specify a threadsafe file system. PSF can only access threadsafe file systems. These file systems are not threadsafe:
  - QNetware
  - QFileSvr.400
  - Network File System (NFS)
  - QDLS
2. If the attachments are to be viewed by the receiver, make sure that they are in a CCSID that matches the CCSID of the target system. For example, if you are using a file that contains the Euro symbol in CCSID 923, ensure that the receiving system uses CCSID 923. Files encoded in EBCDIC are not viewable.
3. If this file is to be used with the **Path name for directory for files**, the file name is appended to that path. Do not use a "/" as the first character when specifying the file name. However, the file are nested within another directory, for example, mySubDirectory/myFile.txt.
4. If this file is not to be used with the **Path name for directory for files**, the file name must be fully-qualified, beginning with a "/".

#### **Offset to path name for directory for files**

Specifies the offset to a path name containing the directory in which files to attach to the e-mail can be stored. This path name must be fully resolved, but if the path name does not end with a "/", PSF adds that character. If you use this field, path names specified with **Offset to list of path names for body of e-mail** and **Offset to list of path names of attachments** are appended to the path specified at the offset for this field. The path names of files must not begin with a "/". However, they can be nested within another directory, for example, mySubDirectory/myFile.txt.

This field is only used when an SMTP mail server is specified in your PSF configuration object. If an SMTP mail server is not specified, set this field to 0. A value of 0 indicates that no path name is specified. If you specify 0, you must specify the complete path name for all files used in the body of the e-mail and as attachments.

To use this directory, specify 1 in the field **Use specified directory** in the Individual Stream File Information format. This format is used when specifying files to be used as attachments or as part of the e-mail body. If you specify 0 for **Use specified directory**, that particular file must have a fully-specified path.

#### **Offset to PDF encryption information**

The offset to the PDF file encryption information. See "PDF Encryption Format" on page 195 for the format to use when specifying this information.

#### **Offset to PDF file public authority**

The offset to the public authorities specified for the PDF file when stored as a stream file in the integrated file system. These are the valid values for the public authority:

**\*ALL** PSF specifies \*RWX for the Public data authority and \*ALL for the Public object authorities.

#### **\*EXCLUDE**

Users do not have any of the data authorities to the object.

**\*RWX** Users have object operational authority and all the data authorities. This lets them change the object and perform basic functions on it. With this authority level, users can perform all operations on the object except those limited to the owner or controlled by object existence, object management, object alter, and object reference authorities.

**\*RX** Users can perform basic operations on the object, such as display its contents. The user cannot change the object. This provides object operational authority and read and execute authorities.

**\*RW** Users can view and change the object. This provides object operational authority and data read, add, update, and delete authorities.

**\*WX** Users can change the contents of an object and run a program or search a library or directory. This authority level provides object operational authority and data add, update, delete, and execute authorities.

**\*R** Users can view the contents of the object. This provides object operation and data read authorities.

**\*W** Users can change the contents of the object. This level of authority provides object operation authority and data add, update, and delete authorities.

- \*X Users can run a program or search a library or directory. This level of authority provides object operation and data execute authorities.

#### **Offset to PDF stream file path and file name**

The offset to the path and file name to use to store the PDF stream file in the integrated file system. For example, /home/user/myfile.pdf. It is recommended that you create all the directories specified for the stream file path. PSF will only create these if QSPLJOB has write authority to the appropriate directories. If Infoprint server creates the directories, they are owned by the original spooled file owner and have the authority specified for \*PUBLIC in the Authority parameter.

If you want a file extension, you must specify it. IBM recommends using a lower-case extension for compatibility with other operating systems. To have PSF give the PDF file the default name, specify 0.

When an SMTP mail server is specified, you must specify a threadsafe file system. These file systems are not threadsafe:

- QNetware
- QFileSvr.400
- Network File System (NFS)
- QDLS

#### **Offset to ReplyTo e-mail address**

Specifies the offset to the reply to e-mail address. Use this address to specify where replies to your e-mail are sent. This can be a different e-mail address than is specified for the PDFSENDER address on the PSF configuration object. If used, this address is sent any non-delivery messages for incorrect e-mail addresses. The address must be in this form: 'name@domain'.

A value of 0 indicates that no reply to address is specified. This field is only used when an SMTP mail server is specified in your PSF configuration object. If an SMTP mail server is not specified, set this field to 0.

#### **Offset to spooled file AFP distribution**

The offset to the AFP spooled file information. See "Spooled File AFPDS Distribution Format" on page 194 for the format to use when specifying this information. If you are not specifying AFP spooled file information, specify 0.

#### **Offset to spooled file PDF distribution**

The offset to the PDF spooled file information. See "Spooled File PDF Distribution Format" on page 193 for the format to use when specifying this information. If you are not specifying PDF spooled file information, specify 0.

#### **Offset to subject**

Offset to the character string to be used as the subject text. A value of 0 indicates that a subject is not specified here. If you do not specify a subject in this structure, then the default subject is used. The default subject is obtained from the original spooled file's name and the first 22 characters of message PQT4133 in message file QPQMSGF.

## **Stream File Format**

This section describes the format to use when specifying stream files in the Extension Area Format. Only use this format when you are specifying stream files to be included in the body or to be attached to the e-mail. The information that needs to be specified for stream files is listed in Table 21 on page 192. You can only specify stream files when an SMTP mail server is specified in your PSF configuration object.

**Note:** The stream files must reside in the integrated file system. In order to use the stream files, the authority to the directories in the path where the stream file resides must be \*X. The authority to the stream files must be \*R.

Table 21. Stream File Information

Decimal Offset	Hex Offset	Type	Description
0	0	BINARY(4)	Total length of stream file information
4	4	BINARY(4)	Number of stream files specified
8	8	CHAR(*)	Stream file information

Detailed information about the fields follows, in alphabetical order according to Description:

**Number of stream files specified**

Indicates the number of stream files that are specified within this format.

**Stream file information**

Specifies the initial offset at which information for each stream file is positioned. See "Individual Stream File Information Format" for information about the format to use when specifying this information. Use one instance of the Individual stream file information format for each stream file. Each instance of this format must be contiguous to the previous one.

**Total length of stream file information**

Specifies the total length of all data used with this structure. This field is included in the length. The specified value must be a 4-byte multiple.

## Individual Stream File Information Format

This section describes the format to use when specifying stream files. Table 22 lists the required format. Use one instance of the Individual stream file information format for each stream file. Each instance of this format must be contiguous to the previous one.

Table 22. Stream File Information Format

Decimal Offset	Hex Offset	Type	Description
0	0	BINARY(4)	Total length of individual stream file format
4	4	BINARY(4)	Length of individual stream file format
8	8	BINARY(4)	Offset to path name
12	C	BINARY(4)	Length of path name
16	10	CHAR(1)	Use specified directory
17	11	CHAR(3)	Reserved (set each byte to X'00')

A detailed description of each field follows, in alphabetical order according to Description:

**Length of individual stream file format**

Specifies the length of the structure used for the Individual stream file format. This value must be 20.

**Length of path name**

Specifies the length of the path name that specifies the stream file.

**Offset to path name**

Specifies the offset to the path name that specifies the stream file. The offset is from the beginning of the Individual stream file information format in which this value is specified. IBM recommends that you create all the directories in this path. PSF can only create them if QSPLJOB had write authority to the appropriate directories.

**Total length of individual stream file format**

Specifies the total contiguous length used with this format, including this field. This value is used to determine the location of the next stream file information format and must be a 4-byte multiple.

**Use specified directory**

Specifies whether the directory specified for stream files (see **Offset to path name for directory for files** in "Extension Area Format" on page 185) is to be prefixed to the name of the stream file. For example, if you specify /SpecialApp/customerOne/ for a directory of files in the Extension area format, this value is prefixed to stream file names when 1 is specified in this field.

'0' Do not prefix the directory to this path. The path name must begin with a "/", otherwise, PSF will search for the file in the home directory for user QSPLJOB.

'1' Prefix the directory to this path. The path name must not begin with a "/", since it is being appended to the specified directory.

## Spooled File PDF Distribution Format

Use this format when you want to spool the PDF output.

Table 23. Spooled File PDF Distribution Format

Decimal Offset	Hex Offset	Type	Description
0	0	CHAR(10)	Name of output queue on which to spool PDF
10	A	CHAR(10)	Output queue library
20	14	CHAR(10)	Spooled file name
30	1E	CHAR(10)	User data
40	28	CHAR(255)	User defined data
295	127	CHAR(10)	Form type

A more detailed description of each entry in the table follows, in alphabetical order according to description:

**Form type**

The form type to be used for the PDF spooled file. Valid values are:

\*SPLF Use the form type of the original spooled file.

*Form-type*

Specify the form type.

**Name of output queue on which to spool PDF**

The name of the output queue on which the PDF will be spooled. Valid values are:

**\*PSFCFG** Use values specified on the PSF configuration object's PDF output queue (PDFOUTQ) parameter for the output queue and library. If you specify \*PSFCFG and the output queue specified on the PSF configuration object does not exist, the file is spooled to QGPL/QPRINT.

*Output-queue* Specify the output queue on which to spool the PDF file. You must also specify the output queue library.

### Output queue library

The library in which the output queue to spool PDF exists. If you specified \*PSFCFG for **Name of output queue on which to spool PDF**, anything you specify for this field is ignored.

### User data

The user data for the PDF spooled file. The possible values are:

**\*SPLF** Use the user data of the original spooled file.

#### *User-data*

Specify the user data.

### Spooled file name

The name used for the new PDF spooled file. The possible values are:

**\*SPLF** Use the original spooled file's name.

#### *spooled-file-name*

Specify a name for the PDF spooled file. If you specify a name that is not valid, PSF names the spooled file QSYSPRT.

### User defined data

The user defined data for the PDF spooled file. The possible values are:

**\*SPLF**

Use the user defined data of the original spooled file.

#### *User-defined-data*

Specify the user defined data.

## Spooled File AFPDS Distribution Format

Use this format when you want to respool the input to the PDF subsystem as an AFP file. In order to respool data as AFP, respooling must be activated in the PSF configuration object by specifying AFPSAVE(\*YES). When your input spooled file is to be split, you can use this format to specify that one or more files created is respooled as AFP. For information about respooling a spooled file as AFP, see "Respool a Spooled File as AFP" on page 70.

Table 24. Spooled File AFPDS Distribution Format

Decimal Offset	Hex Offset	Type	Description
0	0	CHAR(10)	Name of output queue on which to spool AFP
10	A	CHAR(10)	Output queue library
20	14	CHAR(10)	Spooled file name
30	1E	CHAR(10)	User data
4028	11D	CHAR(255)	User defined data
295	127	CHAR(10)	Form type



A more detailed description of each entry in the table follows, in alphabetical order according to description:

**Form type**

The form type to be used for the AFP spooled file. Valid values are:

**\*SPLF** Use the form type of the original spooled file.

*Form-type*

Specify the form type.

**Name of output queue on which to spool AFP**

The name of the output queue on which the AFP will be spooled. Valid values are:

**\*PSFCFG**

Use values specified on the PSF configuration object's AFP output queue (AFPOUTQ) parameter for the output queue and library.

*Output-queue*

Specify the output queue on which to spool the AFP file. You must also specify the output queue library.

**Output queue library**

The library in which the output queue to spool the AFP exists. If you specified **\*PSFCFG** for the **Name of output queue on which to spool AFP** field, anything you specify for this field is ignored.

**User data**

The user data for the AFP spooled file. The possible values are:

**\*SPLF** Use the user data from the original spooled file.

*User-data*

Specify the user data.

**Spooled file name**

The name used for the new AFP spooled file. The possible values are:

**\*SPLF** Use the original spooled file's name.

*spooled-file-name*

Specify a name for the AFP spooled file. If you specify a name that is not valid, PSF names the spooled file QSYSPRT.

**User defined data**

The user defined data for the AFP spooled file. The possible values are:

**\*SPLF**

Use the user defined data from the original spooled file.

*User-defined-data*

Specify the user defined data.

## PDF Encryption Format

Use this format to specify security options for the e-mailed PDF output. If you want to specify encryption, you must have the US encryption (feature number 5722AC3) i5/OS feature installed. This is a free feature in the base operating system. For more information about this feature, see "Specify Encryption and Password Protection for a PDF File" on page 72.

If you do not want the file encrypted, specify '0' for Offset to encryption information.

Table 25. Spooled File PDF Encryption Format

Decimal Offset	Hex Offset	Type	Description
0	0	CHAR(32)	PDF master password
32	20	CHAR(32)	PDF user password
64	40	CHAR(1)	PDF print
65	41	CHAR(1)	PDF document change
66	42	CHAR(1)	PDF copy
67	43	CHAR(1)	PDF encryption level
68	44	CHAR(1)	PDF content access enablement
69	45	CHAR(1)	PDF change comments
70	46	CHAR(1)	PDF document assembly

A more detailed description of each entry in the table follows, in alphabetical order according to description:

#### PDF change comments

Specify whether users have the authority to add or change comments (annotations) or form fields in the PDF document. Valid values are:

'0' Users cannot add or change comments or form fields in the PDF file. Users can fill in form fields.

'1' Users can add or change comments and form fields in the PDF file.

#### PDF content access enablement

Specify the PDF viewer's encryption settings for content access for the visually impaired to the PDF document. This is only configurable with 128-bit encryption. For 40-bit encryption, set this field to '0'. Content access is always disabled if you specify both of these:

**PDF encryption level** = '1' (40-bit)  
**PDF copy** = '0' (Copy is not allowed)

Valid values are:

'0' Content access is not enabled.

'1' Content access is enabled.

#### PDF copy

Specify the PDF viewer's security settings for copying from the PDF document. Content access is disabled if you specify both of these:

**PDF copy** = '0' (Copy is not allowed)  
**PDF encryption level** = '1' (40-bit)

Valid values are:

'0' Copy is not allowed.

'1' Copy is allowed.

#### PDF document assembly

Specify the PDF viewer's security settings for document assembly from the PDF document. This is only configurable with 128-bit encryption. For 40-bit encryption, set this field to '0'.

'0' Document assembly is not allowed.

'1' The user is allowed document assembly. The user can insert, delete,

and rotate pages, and create bookmarks and thumbnails. You can only specify this value if you also specify 128-bit encryption and PDF document change = '1' (yes).

#### **PDF document change**

Specify the PDF viewer's security settings for changing the PDF document.

'0' Change is not allowed. Users cannot create form fields or make any other changes. You cannot specify PDF document assembly = '1' (yes) if you specify that change is not allowed.

'1' The user can change the document.

#### **PDF encryption level**

Specify the encryption level the PDF document using the PDF viewer's encryption settings. If you do not want the file encrypted, specify '0' for offset to encryption information. If you want to specify encryption, you must have the US encryption (feature number 5722AC3) i5/OS feature installed. This is a free feature in the base operating system. For more information about this feature, see "Specify Encryption and Password Protection for a PDF File" on page 72. Valid values are:

'1' 40-bit encryption (Adobe Acrobat 3.X and 4.X) Content access is always disabled if you specify both of these:

**PDF encryption level** = '1' (40-bit)

**PDF copy** = '0' (Copy is not allowed)

'2' 128-bit encryption (Adobe Acrobat 5.0)

#### **PDF master password**

Specify the PDF master password required to change the security settings for the PDF file. When password-protected, the PDF file can be opened with either the user password or master password.

If you set any security restrictions in the file, you should specify a master password. Otherwise, anyone who opens the file could remove the restrictions. If you specify a master password and specify \*NONE for the user password, users can view the PDF file but cannot change the security settings. If you specify any encryption options, you must specify a user password, a master password, or both. Valid values are:

**X'00'** There is no PDF master password on this document.

#### *password*

A string of 32 alphanumeric characters. Only use these characters: 'A'-'Z', 'a'-'z', '0'-'9'. If your password is not 32 characters long, you must pad the password with X'00' or X'40' (not both) to make the 32 character length.

#### **PDF print**

Specify the PDF viewer's security settings for printing the PDF document.

'0' Printing is allowed.

'1' Users are not allowed to print the document.

'2' Only low resolution printing is allowed. You can only specify this value if you also specify 128-bit encryption.

#### **PDF user password**

Specify the password required for the user to open the PDF file. When password-protected, the PDF file can be opened with either the user password or master password.

If you set any security restrictions in the file, you should specify a master password. Otherwise, anyone who opens the file can change the restrictions. If you specify any encryption options, you must specify a user password, a master password, or both. You can specify these values:

**X'00'** There is no user password on this document.

*password*

A string of 32 alphanumeric characters. Only use these characters: 'A'-'Z', 'a'-'z', '0'-'9'. If your password is not 32 characters long, you must pad the password with X'00' or X'40' (not both) to make the 32 character length.

---

## Troubleshooting the PDF Mapping Program

There are several ways to troubleshoot problems with your mapping program:

- Use this document for extended descriptions for message PQT4140 reason codes. See "PDF Mapping Program Reason Codes."
- When PQT4140 is issued, unless the reason code is 15, a spooled file is written with information to help diagnose the problem. See "Diagnostic Spooled File" on page 200.
- If you write your own mapping programs, you can tell PSF to dump out the data passed to and returned by the mapping program. See "Diagnostic Spooled File" on page 200.

**Requirement:** In order for PSF to dump out the data in a mapping program to a spooled file, you must install the PTFs for APAR SE19236 on a V5R2 or later-level server.

### PDF Mapping Program Reason Codes

This section lists the reason codes for this PDF mapping program error message:

**Number:** 4140

**Message:** Incorrect data was returned by mapping program (*library/name*).

**Explanation:** The mapping program specified for device *device* returned incorrect data or indicated that processing should not continue. The reason code is *reason code*. See the reason codes listed below to determine where the error was detected.

- 1 Incorrect value for Disposition of PDF e-mail.
- 2 Incorrect value for More processing.
- 3 A Reserved field does not have each byte set to X'00'.
- 4 Length of message text not in range of 0-255.
- 5 Length of mail address must be 0 when Disposition of PDF e-mail is '0'.
- 6 CCSID must be 0 when using SNDDST for e-mail.
- 7 Length of Extension area must be 52 or 100.
- 8 Length of subject must be greater than 0 when Offset to subject is greater than 0.
- 9 When using SNDDST, all fields for specifying ReplyTo, CC, BCC, body files, attachments, and directory names must be 0.
- 10 BCC offset and BCC length are not compatible.

- 11 CC offset and CC length are not compatible.
- 12 REPLYTO offset and REPLYTO length are not compatible.
- 13 REPLYTO offset cannot be less than 0.
- 14 Use of path directory specified, but no path directory was entered.
- 15 Disposition of PDF Error is set to 1, Do not continue processing.
- 16 Incompatible values specified for Offset to PDF file public authority and Length of PDF file public authority.
- 17 Incorrect value for Public authorization. Valid values are \*EXCLUDE, \*ALL, \*RWX, \*RX, \*RW, \*WX, \*W, \*R, and \*X.
- 18 Incompatible values specified for Offset to PDF stream file path and file name and Length of PDF stream file path and file name.
- 19 Incompatible values specified for Offset to spooled file PDF distribution and Length of spooled file PDF distribution.
- 20 Values for Offset to PDF file name for e-mail and Length of PDF file name for e-mail are not compatible. One value is 0 but the other value is not 0.
- 21 Length of PDF encryption information cannot be less than 0.
- 22 Incorrect value for Disposition of PDF error.
- 23 Incorrect value for Disposition of PDF stream file.
- 24 Incorrect value for Disposition of PDF spooled file.
- 25 Message text must be blank when Length of message text is 0.
- 26 Length of mail address must be greater than 0 when Disposition of PDF e-mail is '1'.
- 27 CCSID must be in range of 0-65533 when using SMTP for e-mail.
- 28 The IBM mapping program set Length of Extension area incorrectly. Report the problem (ANZPRB command).
- 29 Length of subject is less than 0.
- 30 Length of PDF file name for e-mail for SNDDST must be in range 1-12.
- 31 BCC offset cannot be less than 0.
- 32 CC offset cannot be less than 0.
- 33 Value for Length of spooled file PDF distribution must be 305.
- 34 Value for Name of output queue in Spooled File Distribution Format is either blank or not left justified.
- 35 Value for Name of output queue in Spooled File Distribution Format must be \*PSFCFG when Output queue library is blank.
- 36 PDF Encryption - Value for PDF print must be '0', '1' or '2'.
- 37 PDF Encryption - PDF document change must be '0' or '1'.
- 38 PDF Encryption - Value for PDF copy must be '0' or '1'.
- 39 PDF Encryption - Value for PDF encryption level must be '0' or '1'.
- 40 PDF Encryption - Value for PDF content access enablement must be '0' or '1'.
- 41 PDF Encryption - Value for PDF change comments must be '0' or '1'.

42 PDF Encryption - Value for PDF document assembly must be '0' or '1'.

**User response:** Correct the values being passed from the mapping program and resubmit the spooled file. The spooled file is held and processing continues with the next ready file. If the reason code is 15, the spooled file is segmented, and a PDF administrator is specified in the PSF configuration object, processing continues with the next segment. The spooled file is placed on hold after all segments have been processed.

## Diagnostic Spooled File

The diagnostic spooled file is meant to be used with message PQT4140. It gives you in-depth information about your mapping program. Using this information along with the reason code issued with message PQT4140 will help you diagnose problems with your mapping program. PSF produces a spooled file if an error is detected with your mapping program, unless reason code 15 is issued. Therefore, it is possible that you will get another diagnostic spooled file later because a different error is found. This section describes the format of this spooled file and contains an example spooled file. There are two ways the diagnostic spooled file can be written:

- PSF writes a spooled file named PSFTRACE whenever message PQT4140 is issued, except when the reason code is 15. This spooled file lists the fields that PSF found to be in error. For an example of this spooled file, see "PSF-Requested Spooled File" on page 203.
- You can request that the PSFTRACE spooled file is written. This spooled file lists only the fields used by your mapping program. If you request that the spooled file is written and an error is encountered, one spooled file will be written with both sets of information in it; first the user-requested information and then the error information. For instructions, see "Generating a Dump of Your Mapping Program" on page 202. For an example of this spooled file, see "User-Requested Spooled File" on page 204.

To find PSFTRACE, use the command WRKSPLF QSPLJOB. The spooled file will have the same job number as the PDJ job (one of the three PSF jobs). If a file is being respooled and the mapping program is called, the PSFTRACE dump of the mapping program interface, will be generated for the WTR job. Check for PSFTRACE after the writer has ended.

### Format of the PSFTRACE spooled file

The first eight characters of each line in this spooled file describe the data that follows, except when the line is actual input or output. The formats named below, such as Spooled File AFPDS Distribution format correspond to values in the mapping program template. For more information about any of the formats discussed below, see the appropriate section in "Parameters" on page 179. These are the possible values with their descriptions:

#### **AFP OUTQ**

Spooled File AFPDS Distribution format.

#### **ATTACH**

Attachments.

#### **BODY FIL**

Body files.

**BCC** The specified BCC e-mail address.

**CC** The specified CC e-mail address.

**EXT AREA**  
Extension Area format.

**INPUT**  
Mapping Program Input information format.

**ISF FORM**  
Individual Stream File Information format.

**MAP OBJ**  
Name of PDF map object, if used.

**MAP PGM**  
Library-qualified name of mapping program.

**OFFSET**  
The offset at which the field in error is found in the mapping program.  
This value is written in decimal and hexadecimal.

**OUTPUT**  
Mapping Program Output format.

**PDF MAIL**  
Name of PDF file attached to e-mail.

**PDF OUTQ**  
Spooled File PDF Distribution format.

**PUB AUT**  
Public authority of PDF file written to integrated file system.

**RC** Reason code from message PQT4140. If the reason code is FF or AA, then this spooled file was requested by a customer. FF indicates that the spooled file was written by the PDJ job. AA indicates that the spooled file was written by the WTR job.

**REPLYTO**  
The specified REPLYTO e-mail address.

**SENDER**  
Sender of e-mail.

**SF FORM**  
Stream File format.

**STMF** Name of PDF file written to integrated file system.

**SUBJECT**  
Subject of e-mail.

**TO** The specified TO e-mail address.

**USR VALU**  
The value specified in the mapping program. This value is written, depending upon the field, in either character or numeric (decimal and hexadecimal).

**VALID**  
The valid values for the fields found to be in error.

All lines of the spooled file have a time stamp.

When data is written in hexadecimal, the following will have the offset of the information specified, in hexadecimal, in the first column on the left. You can use these hexadecimal offsets to find specific fields:

- AFP OUTQ
- ATTACH
- BCC
- BODY FIL
- CC
- EXT AREA
- INPUT
- OUTPUT
- PDF MAIL
- PDF OUTQ
- PUB AUT
- REPLYTO
- SENDER
- SUBJECT
- STMF
- TO

### Generating a Dump of Your Mapping Program

You can request that PSF write out information passed to and received from a mapping program in a diagnostic spooled file called PSFTRACE. For an example of this spooled file, see “User-Requested Spooled File” on page 204. To request that this spooled file be generated, create a data area as described below.

#### Important:

1. This data area must be created before starting the printer writer.
2. The data area must be created in QGPL.
3. The name of the data area must match that of the printer device description being used for printing.

To create the data area, enter the following command.

```
CRDTAARA DTAARA(QGPL/printer_device_name)
          TYPE(*CHAR)
          LEN(40)
          VALUE(X'E6E6D7C4E3D9C8D98000000000000800000000
                00000000320000000000000000000000000000')
          AUT(*ALL)
```

When the information is no longer required, delete the data area by using this command:

```
DLDTAARA DTAARA(QGPL/printer_device_name)
```

To verify the accuracy of the value placed into the data area, enter the following command:

```
DSPDTAARA DTAARA(QGPL/printer_device_name) OUTFMT(*HEX)
```

The hexadecimal data displayed must be the same as the hexadecimal data shown when you run the command above. The first eight characters of the value for the data area MUST be “WWPDTRHR”.



## Sample Spooled Files

There are two ways that a PSFTRACE spooled file can be written:

- PSF writes the information to a spooled file when it encounters an error in the mapping program. See “PSF-Requested Spooled File” for an example.
- PSF writes the information to a spooled file when a user requests it to do so. See “User-Requested Spooled File” on page 204 for an example.

For more information about any of the Formats discussed below, refer to the *Infoprint Server for iSeries: User’s Guide*.

**PSF-Requested Spooled File:** This is an example of a diagnostic spooled file that was created because PSF detected an error in the mapping program. The diagnostic spooled file contains this information:

- The name of the mapping program is QPQMAPEXIT. It is in library QSYS.
- The name of the map object is TEST. It is in library PKLAR.
- The reason code issued with error message PQT4140 is 9. Reason code 9 is “When using SNDDST, all fields for specifying ReplyTo, CC, BCC, body files, attachments, and directory names must be 0.” The reason codes are listed in “PDF Mapping Program Reason Codes” on page 198.
- The input to the mapping program (Mapping Program Input Information format) is presented in hexadecimal representation. At the end of each line is the EBCDIC representation of the input. Not all characters can be displayed. In this example, characters that cannot be displayed are represented by a period ( . ).
- An error was found in the mapping program in the Extension Area format at offset 00000012 (decimal) or 0000000C (hexadecimal). The value in that field is 00000433 (decimal) or 000001B1 (hexadecimal). To determine what field that is in the mapping program and what the appropriate values are, see the appropriate section in “Parameters” on page 179. In this case, the field is Offset to ReplyTo e-mail address. It has a value of 433 (decimal).
- A total of 10 errors were found. Each error starts with the text “OFFSET”.
- The valid value for all of these fields is 0.
- The output from the mapping program (Mapping Program Output format) is presented in hexadecimal representation. At the end of each line is the EBCDIC representation of the input. Not all characters can be displayed. In this example, characters that cannot be displayed are represented by a period ( . ).
- The output from the Extension Area format is presented in hexadecimal representation. At the end of each line is the EBCDIC representation of the input. Not all characters can be displayed. In this example, characters that cannot be displayed are represented by a period ( . ).

```
***** 12:28:40.042 *****
MAP PGM 12:28:40.042 QSYS      QPQMAPEXIT
MAP OBJ 12:28:40.042 PKLAR    TEST
RC      12:28:40.042 09
INPUT   12:28:40.042
000000 D8D7C1C4 C5E5F0F0 F0C8D1D2 D3C1D940 40404040 F8F2F5F5 F3F1D6D5 C5D7C1C7 QPADEV000HPKLAR.....825531ONEPAG
000020 C5404040 00000001 40404040 40404040 40404040 40404040 40404040 40404040 40404040 E.....
000040 40404040 40404040 40404040 40404040 40404040 40404040 40404040 40404040 .....
000060 40404040 40404040 40404040 40404040 40404040 40404040 40404040 40404040 .....
000080 40404040 40404040 40404040 40404040 40404040 40404040 40404040 40404040 .....
0000A0 40404040 40404040 40404040 40404040 40404040 40404040 40404040 40404040 .....
0000C0 40404040 40404040 40404040 40404040 40404040 40404040 40404040 40404040 .....
0000E0 40404040 40404040 40404040 40404040 40404040 40404040 40404040 40404040 .....
000100 40404040 40404040 40404040 40404040 40404040 40404040 40404040 40404040 .....
000120 404061D7 E2C6F4F0 F061F8F2 F9F8F6F3 61D8D7C1 C4C5E5F0 F0F0C861 D1D2D3C1 ...PSF400.829863.QPADEV000H.PKLA
000140 D961F8F2 F5F5F3F1 6DF0F0F0 F0F0F16D D6D5C5D7 C1C7C56D F0F2F2F3 F2F0F0F5 R.825531.000001.ONEPAGE.02232005
000160 6DF0F0F0 F0F0F14B D7C4C640 40404040 40404040 40404040 40404040 40404040 .000001.PDF.....
```

```

000180 40404040 40404040 40404040 40404040 40404040 40404040 40404040 40404040 .....
0001A0 40404040 40404040 40404040 40404040 40404040 40404040 40404040 40404040 .....
0001C0 40404040 40404040 40404040 40404040 40404040 40404040 40404040 40404040 .....
0001E0 40404040 40404040 40404040 40404040 40404040 40404040 40404040 40404040 .....
000200 40404040 40404040 40404040 40404040 40404040 40404040 40404040 40404040 .....
000220 40404040 40404040 40404040 40404040 40404040 40404040 40404040 40404040 .....
000240 40404040 40404040 40404040 40404040 40404040 40404040 40404040 40404040 .....
000260 40404040 40404040 40404040 40404040 40404040 4040F140 0000FFFF D1D2D3C1 .....1.....PKLA
000280 D9404040 40404040 40404040 40404040 C9E2C5D9 C9C5E2C7 89230278 766FE4D8 R.....ISERIESGj.....UQ
0002A0 D1D2D7C4 C6404040 4040D8E4 E2D9E2E8 E2404040 E3C5E2E3 40404040 4040D1D2 PKPDF.....QUSRSYS...TEST.....PK
0002C0 D3C1D940 40404040 5CE2E3C4 40404040 4040 LAR.....STD.....
OFFSET 12:28:40.043 EXT AREA 00000012 HEX: 0000000C
USR VAL 12:28:40.043 00000433 HEX: 000001B1
OFFSET 12:28:40.043 EXT AREA 00000016 HEX: 00000010
USR VAL 12:28:40.043 00000022 HEX: 00000016
OFFSET 12:28:40.043 EXT AREA 00000020 HEX: 00000014
USR VAL 12:28:40.043 00000476 HEX: 000001DC
OFFSET 12:28:40.043 EXT AREA 00000024 HEX: 00000018
USR VAL 12:28:40.043 00000018 HEX: 00000012
OFFSET 12:28:40.043 EXT AREA 00000028 HEX: 0000001C
USR VAL 12:28:40.043 00000494 HEX: 000001EE
OFFSET 12:28:40.043 EXT AREA 00000032 HEX: 00000020
USR VAL 12:28:40.043 00000018 HEX: 00000012
OFFSET 12:28:40.043 EXT AREA 00000036 HEX: 00000024
USR VAL 12:28:40.043 00003270 HEX: 00000CC6
OFFSET 12:28:40.043 EXT AREA 00000040 HEX: 00000028
USR VAL 12:28:40.043 00000000 HEX: 00000000
OFFSET 12:28:40.043 EXT AREA 00000044 HEX: 0000002C
USR VAL 12:28:40.043 00000000 HEX: 00000000
OFFSET 12:28:40.043 EXT AREA 00000048 HEX: 00000030
USR VAL 12:28:40.043 00000512 HEX: 00000200
VALID 12:28:40.069 0
OUTPUT 12:28:40.069
000000 F1F00000 000000FF 00000016 D7938581 A2854095 96A38540 96A49940 9585A640 10.....Please.note.our.new.
000020 8896A499 A24B4040 40404040 40404040 40404040 40404040 40404040 40404040 hours.....
000040 40404040 40404040 40404040 40404040 40404040 40404040 40404040 40404040 .....
000060 40404040 40404040 40404040 40404040 40404040 40404040 40404040 40404040 .....
000080 40404040 40404040 40404040 40404040 40404040 40404040 40404040 40404040 .....
0000A0 40404040 40404040 40404040 40404040 40404040 40404040 40404040 40404040 .....
0000C0 40404040 40404040 40404040 40404040 40404040 40404040 40404040 40404040 .....
0000E0 40404040 40404040 40404040 40404040 40404040 40404040 40404040 40404040 .....
000100 40404040 40404040 40404000 00000135 00000000 F1F1F0F1 00000000 0000007D .....1101.....
000120 8584A681 9984A27C 82819999 85934B83 964BA492 7D000000 6E000001 A3000000 edwardo.barrel.co.uk.....t...
000140 0E000001 B1000000 16000001 DC000000 12 .....
EXT ARE 12:28:40.070
000000 0000006E 000001A3 0000000E 000001B1 00000016 000001DC 00000012 000001EE .....t.....
000020 00000012 00000CC6 00000000 00000000 00000200 0000178C 0000002C 000001C7 .....F.....G
000040 00000015 000017B8 00000004 000017BC 00000131 000018ED 00000131 00000000 .....
000060 00000000 C5C4E6C1 D9C4E240 4040 ....EDWARDS...
***** 12:28:40.070 *****

```

**User-Requested Spooled File:** The user-requested diagnostic spooled file contains only the information that the user requests. In this example, a complete dump of the mapping program was requested. All data is presented in hexadecimal representation. At the end of each line is the EBCDIC representation of the data. Not all characters can be displayed. In this example, characters that cannot be displayed are represented by a period ( . ). The spooled file gives us this information:

- The mapping program is QPQMAPEXIT in library QSYS.
- The map object is TEST in library PKLAR
- The reason code is listed as FF or AA, which indicates that this information was user-requested. FF indicates that the spooled file was written by the PDJ job. AA indicates that the spooled file was written by the WTR job.

- The data in the various mapping program formats is displayed. The formats displayed depend on what was requested by the user. This example contains the following formats:
  - Mapping Program Input Information format
  - Mapping Program Output format
  - Extension Area format
    - Subject
    - Reply-to e-mail address
    - CC e-mail address
    - BCC e-mail address
    - Name of PDF stream file written to the integrated file system
    - Name of PDF file attached to e-mail
    - Public authority for the PDF file
  - Spooled File PDF Distribution format
  - Spooled File AFPDS Distribution format
  - PDF Encryption format
  - Mail sender (found in the Extension Area format)
  - Stream File format
  - Individual Stream File Information format
    - Stream file to include in body of e-mail
  - Individual Stream File Information format
    - Stream file to include in body of e-mail
  - Stream File format
  - Individual Stream File Information format
    - Stream file to include as attachment to e-mail
  - Individual Stream File Information format
    - Stream file to include as attachment to e-mail

```

*****12:12:34.854 *****
MAP PGM 12:12:34.879 QSYS      QPQMAPEXIT
MAP OBJ 12:12:34.879 PKLAR    TEST
RC      12:12:34.879 FF
INPUT   12:12:34.880
000000 D8D7C1C4 C5E5F0F0 F0C8D7D2 D3C1D940 40404040 F8F2F5F5 F3F1D6D5 C5D7C1C7 QPADEV000HPKLAR.....825531ONEPAG
000020 C5404040 00000001 40404040 40404040 40404040 40404040 40404040 40404040 40404040 E.....
000040 40404040 40404040 40404040 40404040 40404040 40404040 40404040 40404040 .....
000060 40404040 40404040 40404040 40404040 40404040 40404040 40404040 40404040 .....
000080 40404040 40404040 40404040 40404040 40404040 40404040 40404040 40404040 .....
0000A0 40404040 40404040 40404040 40404040 40404040 40404040 40404040 40404040 .....
0000C0 40404040 40404040 40404040 40404040 40404040 40404040 40404040 40404040 .....
0000E0 40404040 40404040 40404040 40404040 40404040 40404040 40404040 40404040 .....
000100 40404040 40404040 40404040 40404040 40404040 40404040 40404040 40404040 .....
000120 40404040 40404040 40404040 40404040 40404040 40404040 40404040 40404040 .....
000140 40404040 40404040 40404040 40404040 40404040 40404040 40404040 40404040 .....
000160 40404040 40404040 40404040 40404040 40404040 40404040 40404040 40404040 .....
000180 40404040 40404040 40404040 40404040 40404040 40404040 40404040 40404040 .....
0001A0 40404040 40404040 40404040 40404040 40404040 40404040 40404040 40404040 .....
0001C0 40404040 40404040 40404040 40404040 40404040 40404040 40404040 40404040 .....
0001E0 40404040 40404040 40404040 40404040 40404040 40404040 40404040 40404040 .....
000200 40404040 40404040 40404040 40404040 40404040 40404040 40404040 40404040 .....
000220 40404040 40404040 40404040 40404040 40404040 40404040 40404040 40404040 .....
000240 40404040 40404040 40404040 40404040 40404040 40404040 40404040 40404040 .....
000260 40404040 40404040 40404040 40404040 40404040 4040F140 0000FFFF D7D2D3C1 .....1.....PKLA
000280 D9404040 40404040 40404040 40404040 C9E2C5D9 C9C5E2C7 89230278 766FE4D8 R.....ISERIESGi.....UQ
0002A0 D7D2D7C4 C6404040 4040D8E4 E2D9E2E8 E2404040 E3C5E2E3 40404040 4040D7D2 PKPDF.....QUSRSYS...TEST.....PK
0002C0 D3C1D940 40404040 5CE2E3C4 40404040 4040 LAR.....STD.....
OUTPUT 12:12:34.880

```

```

000000 F1F00000 000000FF 00000016 D7938581 A2854095 96A38540 96A49940 9585A640 10.....Please.note.our.new.
000020 8896A499 A24B4040 40404040 40404040 40404040 40404040 40404040 40404040 hours.....
000040 40404040 40404040 40404040 40404040 40404040 40404040 40404040 40404040 .....
000060 40404040 40404040 40404040 40404040 40404040 40404040 40404040 40404040 .....
000080 40404040 40404040 40404040 40404040 40404040 40404040 40404040 40404040 .....
0000A0 40404040 40404040 40404040 40404040 40404040 40404040 40404040 40404040 .....
0000C0 40404040 40404040 40404040 40404040 40404040 40404040 40404040 40404040 .....
0000E0 40404040 40404040 40404040 40404040 40404040 40404040 40404040 40404040 .....
000100 40404040 40404040 40404000 00000135 00000000 F1F1F0F1 00000000 00000000 .....1101.....
TO 12:12:34.885
000000 7D999695 958985A2 8396A3A3 A27C9996 95958985 A28396A3 A3A24B83 964BA492 .ronniescotts.ronniescotts.co.uk
000020 7D7D85A5 8595A3A2 7C9789A9 A98185A7 979985A2 A24B8396 947D7D81 99A28595 ..events.pizzaexpress.com..arsen
000040 81939793 AA427CA5 89848596 9396A495 8785A3A5 4B839694 7D7D8396 95A38183 a1plus.videoloungetcv.com..contac
000060 A37CA288 9685A284 89998583 A34B8396 4BA4927D 7D998194 82938599 A27C9396 t.shoesdirect.co.uk..ramblers.lo
000080 95849695 4B998194 82938599 A24B9699 874BA492 7D7D8389 A3A84B83 96A49583 ndon.ramblers.org.uk..city.counc
0000A0 89937C94 81958388 85A2A385 994B8796 A54BA492 7D il.manchester.gov.uk.
EXT AREA 12:12:34.903
000000 0000006E 000001A3 0000000E 000001B1 00000016 000001DC 00000012 000001EE .....t.....
000020 00000012 00000CC6 00000000 00000000 00000200 000017D3 0000002C 000001C7 .....F.....L.....G
000040 00000015 000017FF 00000004 000001803 00000131 00001934 00000131 0000178C .....
000060 00000047 C5C4E6C1 D9C4E240 4040 .....EDWARDS...
SUBJECT 12:12:34.903
000000 D585A640 9985A2A3 81A49981 95A3 New.restaurant
REPLYTO 12:12:34.903
000000 7D828585 8388A494 7C828199 9985934B 83964BA4 927D .beechem.barrel.co.uk.
CC 12:12:34.903
000000 7D948599 83927C95 96A5814B 83964B81 A47D .merck.nova.co.au.
BCC 12:12:34.903
000000 7D8881A4 A27C9799 96A2A34B 83964B84 857D .haus.prost.co.de.
STMF 12:12:34.903
000000 61889694 856183A4 A2A39694 8599C995 869661D9 85A2A381 A4998195 A3C99586 .home.customerInfo.RestaurantInf
000020 96999481 A3899695 4B978486 ormation.pdf
PDF MAIL 12:12:34.904
000000 D985A2A3 81A49981 95A3C995 86969994 81A38996 95 RestaurantInformation
PUB AUT 12:12:34.904
000000 5CC1D3D3 .ALL
PDF OUTQ 12:12:34.904
000000 C5C4E6C1 D9C4E240 4040D8C7 D7D34040 40404040 5CE2D7D3 C6404040 4040D7C4 EDWARDS...QGPL.....SPLF.....PD
000020 C6E4E2C5 D9C4E3C1 5CE2D7D3 C6404040 40404040 40404040 40404040 40404040 FUSERDTA.SPLF.....
000040 40404040 40404040 40404040 40404040 40404040 40404040 40404040 .....
000060 40404040 40404040 40404040 40404040 40404040 40404040 40404040 .....
000080 40404040 40404040 40404040 40404040 40404040 40404040 40404040 .....
0000A0 40404040 40404040 40404040 40404040 40404040 40404040 40404040 .....
0000C0 40404040 40404040 40404040 40404040 40404040 40404040 40404040 .....
0000E0 40404040 40404040 40404040 40404040 40404040 40404040 40404040 .....
000100 40404040 40404040 40404040 40404040 40404040 40404040 40404040 .....
000120 40404040 4040405C E2D7D3C6 40404040 40 .....SPLF.....
AFP OUTQ 12:12:34.904
000000 C5C4E6C1 D9C4E240 4040D8C7 D7D34040 40404040 5CE2D7D3 C6404040 40405CE2 EDWARDS...QGPL.....SPLF.....S
000020 D7D3C640 40404040 5CE2D7D3 C6404040 40404040 40404040 40404040 40404040 PLF.....SPLF.....
000040 40404040 40404040 40404040 40404040 40404040 40404040 40404040 .....
000060 40404040 40404040 40404040 40404040 40404040 40404040 40404040 .....
000080 40404040 40404040 40404040 40404040 40404040 40404040 40404040 .....
0000A0 40404040 40404040 40404040 40404040 40404040 40404040 40404040 .....
0000C0 40404040 40404040 40404040 40404040 40404040 40404040 40404040 .....
0000E0 40404040 40404040 40404040 40404040 40404040 40404040 40404040 .....
000100 40404040 40404040 40404040 40404040 40404040 40404040 40404040 .....
000120 40404040 4040405C E2E3C440 40404040 40 .....STD.....
ENCRYPT 12:12:34.908
000000 00000000 00000000 00000000 00000000 00000000 00000000 00000000 00000000 .....
000020 00000000 00000000 00000000 00000000 00000000 00000000 00000000 00000000 .....
000040 F1F0F1F2 F0F0F0 1012000
SENDER 12:12:34.908
000000 C5C4E6C1 D9C4E240 4040 EDWARDS...
SF FORM 12:12:34.908 00000AC600000002
ISF FORM 12:12:34.908 00000113000000140000001400000012F0000000
BODY FIL 12:12:34.908
000000 D985A2A3 81A49981 95A3D485 95A44B88 A394 RestaurantMenu.htm
ISF FORM 12:12:34.908 0000011300000014000000140000001EF0000000
BODY FIL 12:12:34.909

```

000000 61889694 85618584 A6819984 A2619788 969585D5 A4948285 99A24BA3 A7A3 .home.edwards.phoneNumbers.txt  
SF FORM 12:12:34.909 00000AC600000002  
ISF FORM 12:12:34.909 0000011300000014000000140000001DF0000000  
ATTACH 12:12:34.909  
000000 61889694 85618396 958385A2 A2899695 A261C396 A4979695 A24B9784 86 .home.concessions.Coupons.pdf  
ISF FORM 12:12:34.909 00000113000000140000001400000020F0000000  
ATTACH 12:12:34.909  
000000 61889694 85619788 96A396A2 61C69996 95A3D686 C2A48993 84899587 4B919787 .home.photos.FrontOfBuilding.jpg  
\*\*\*\*\*12:12:34.909 \*\*\*\*\*



---

## Appendix C. Templates

This appendix contains these templates:

- “PDF Mapping Program in C”
- “PDF Mapping Program in RPG” on page 212

Before using the templates, read the information in “Code license disclaimer information” on page 216.

---

### PDF Mapping Program in C

This is a template for a mapping program. It is an illustration intended to explain how to use a mapping program. Before using this program, you must customize it for your environment. A mapping program is an exit program that helps you customize the PDF subsystem. For information about using the PDF subsystem, see Chapter 4, “Using the PDF Subsystem,” on page 59. For information about the exit program, see Appendix B, “Mapping Program,” on page 177.

```
/*-----*/
/*---                                          ---*/
/*--- Calling convention:                    ---*/
/*--- Pointer to Email exit input information. (char *, defined by Qpq_email_Exit_I_t ---*/
/*---                                     in epqmapxt.h)                               ---*/
/*--- Length of input information (int, the 4 byte variety)                       ---*/
/*--- Pointer to Email exit output information. (char *, defined by Qpq_Email_Exit_0_t ---*/
/*---                                     in epqmapxt.h)                               ---*/
/*---                                          ---*/
/*--- Length of output information buffer (int, the 4 byte variety)                ---*/
/*--- Length of output information available (int, the 4 byte variety)            ---*/
/*---                                          ---*/
/*-----*/

#include stdio.h
#include fstream.h
#include stdlib.h
#include string.h
#include ctype.h
#include errno.h
#include fstream.h
#include "epqmapxt.cleinc"

#define MAIL_ADDR_DATA_LENGTH 1024

typedef _Packed struct myOutput {
    Qpq_Email_Exit_0_t Exit_Output_Struct;
    char Email_Addr_Data[MAIL_ADDR_DATA_LENGTH];
    Qpq_Email_Exit_E_t Exit_Extension_Area;
    char Reply_To[256];
    char CC_Email_Addresses[256];
    char BCC_Email_Addresses[256];
    char Subject_String[256];
    char Attachments_Directory[256];
    Qpq_All_Stream_Files_t Attachments;
    Qpq_Stream_File_t Attachment_Struct;
    char Attachment_Path_Name[256];
    Qpq_All_Stream_Files_t All_Body_Files;
    Qpq_Stream_File_t Body_Attachment_Struct;
    char Body_Attachment_Path_Name[256];
    char PDF_File_Name[256];
    char PDF_File_Path[256];
    char PDF_File_Authority[10];
    Qpq_PDF_Spooled_File PDF_SpoolFile;
    Qpq_AFP_Spooled_File AFP_SpoolFile;
};
```

```

    Qpq_PDF_Encryption    PDF_Encryption;
} myOutput;

int main(int argc, char* argv[])
{
    /* Map Input and Output Structures to the arguments */

    Qpq_Email_Exit_I_t *input;
    myOutput *myOutputPtr;
    input = ( Qpq_Email_Exit_I_t * ) argv[1];
    myOutputPtr = (myOutput*)argv[3];

    /******
    /***** Initialize exitAllOutput struct variable 'myOutputPtr' *****/
    /******
    /----- Initialize struct Qpq_Email_Exit_0_t -----*/
    memset(myOutputPtr, ' ', sizeof(*myOutputPtr) );
    myOutputPtr->Exit_Output_Struct.PDF_File_Disposition[0]      = '0';
    myOutputPtr->Exit_Output_Struct.Call_Exit_Program_Again[0]   = '0';
    memset(myOutputPtr->Exit_Output_Struct.Reserved1, '\0', 2);
    myOutputPtr->Exit_Output_Struct.Message_Text_Length          = 0;
    myOutputPtr->Exit_Output_Struct.Mail_address_data_length     = 0;
    memset( myOutputPtr->Exit_Output_Struct.Message_text_data, ' ', 255);
    myOutputPtr->Exit_Output_Struct.Reserved2[0]                 = '\0';
    myOutputPtr->Exit_Output_Struct.Offset_To_Extension_Area     = 1311;
    myOutputPtr->Exit_Output_Struct.CCSID_Message_Text_And_Subject = 0;
    myOutputPtr->Exit_Output_Struct.PDF_Stream_File_Disposition[0] = '0';
    myOutputPtr->Exit_Output_Struct.PDF_Spooled_File_Disposition[0] = '0';
    myOutputPtr->Exit_Output_Struct.PDF_Error_Disposition[0]     = '0';
    myOutputPtr->Exit_Output_Struct.AFP_Spooled_File_Disposition[0] = '0';
    memset(myOutputPtr->Exit_Output_Struct.Reserved3, '\0',7);
    /*----- Initialize struct Qpq_Email_Exit_E_t -----*/
    myOutputPtr->Exit_Extension_Area.Length_Extension_Area       = 100;
    myOutputPtr->Exit_Extension_Area.Offset_Subject              = 2179;
    myOutputPtr->Exit_Extension_Area.Length_Subject              = 0;
    myOutputPtr->Exit_Extension_Area.Offset_ReplyTo              = 1411;
    myOutputPtr->Exit_Extension_Area.Length_ReplyTo              = 0;
    myOutputPtr->Exit_Extension_Area.Offset_CC                    = 1667;
    myOutputPtr->Exit_Extension_Area.Length_CC                    = 0;
    myOutputPtr->Exit_Extension_Area.Offset_BCC                  = 1923;
    myOutputPtr->Exit_Extension_Area.Length_BCC                  = 0;
    myOutputPtr->Exit_Extension_Area.Offset_Path_Body            = 2975;
    myOutputPtr->Exit_Extension_Area.Offset_Attachments_Directory = 2435;
    myOutputPtr->Exit_Extension_Area.Length_Attachments_Directory = 0;
    myOutputPtr->Exit_Extension_Area.Offset_Attachments          = 2691;
    myOutputPtr->Exit_Extension_Area.Offset_PDF_File_Name        = 3259;
    myOutputPtr->Exit_Extension_Area.Length_PDF_File_Name        = 0;
    myOutputPtr->Exit_Extension_Area.Offset_PDF_File_Path        = 3515;
    myOutputPtr->Exit_Extension_Area.Length_PDF_File_Path        = 0;
    myOutputPtr->Exit_Extension_Area.Offset_PDF_File_Authority   = 3771;
    myOutputPtr->Exit_Extension_Area.Offset_PDF_Spooledfile      = 3781;
    myOutputPtr->Exit_Extension_Area.Length_PDF_Spooledfile      = 305;
    myOutputPtr->Exit_Extension_Area.Offset_AFP_Spooledfile      = 4086;
    myOutputPtr->Exit_Extension_Area.Length_AFP_Spooledfile      = 305;
    myOutputPtr->Exit_Extension_Area.Offset_PDF_Encryption       = 4391;
    myOutputPtr->Exit_Extension_Area.Length_PDF_Encryption       = 71;
    myOutputPtr->PDF_Encryption.PDF_Owner_Password[0]            = '\0';
    myOutputPtr->PDF_Encryption.PDF_User_Password[0]             = '\0';
    myOutputPtr->PDF_Encryption.PDF_Printing[0]                  = '\0';
    myOutputPtr->PDF_Encryption.PDF_Changing_Document[0]       = '\0';
    myOutputPtr->PDF_Encryption.PDF_Copy[0]                      = '\0';
    myOutputPtr->PDF_Encryption.PDF_Encryption_Level[0]         = '\0';

    /* TO Data */

    strcpy(myOutputPtr->Email_Addr_Data, "ibmer@us.ibm.com");
    myOutputPtr->Exit_Output_Struct.Mail_address_data_length = strlen(myOutputPtr->Email_Addr_Data);

    /* Reply To Data */

    strcpy(myOutputPtr->Reply_To, "noway@jose.com");

```



```

myOutputPtr->Exit_Extension_Area.Length_ReplyTo = strlen(myOutputPtr->Reply_To);

/* Subject */
strcpy(myOutputPtr->Subject_String, "This is an email" );
myOutputPtr->Exit_Extension_Area.Length_Subject = strlen(myOutputPtr->Subject_String);

/* CCs */
strcpy(myOutputPtr->CC_Email_Addresses , "CCs@us.ibm.com" ) ;

myOutputPtr->Exit_Extension_Area.Length_CC = strlen(myOutputPtr->CC_Email_Addresses);

/* BCCs */
strcpy(myOutputPtr->BCC_Email_Addresses, "BCCs@us.ibm.com");
myOutputPtr->Exit_Extension_Area.Length_BCC = strlen(myOutputPtr->BCC_Email_Addresses);

/* Attachment Directory */
strcpy(myOutputPtr->Attachments_Directory , "/home/myAttachments");
myOutputPtr->Exit_Extension_Area.Length_Attachments_Directory = strlen(myOutputPtr->Attachments_Directory );

/* Email Disposition */
myOutputPtr->Exit_Output_Struct.PDF_File_Disposition[0] = '1';

/* More Processing Flag */
myOutputPtr->Exit_Output_Struct.Call_Exit_Program_Again[0] = '0';

/* Message Text Data */
strcpy(myOutputPtr->Exit_Output_Struct.Message_text_data, " Please read the attached PDF File " );
myOutputPtr->Exit_Output_Struct.Message_Text_Length = 255;

/* Indicate an IFS file to embed in the Body of the Email */
strcpy ( myOutputPtr->Body_Attachment_Path_Name, "bodyattach.txt" );
myOutputPtr->Body_Attachment_Struct.Length_Path_Name = strlen(myOutputPtr->Body_Attachment_Path_Name ) ;
myOutputPtr->Body_Attachment_Struct.Use_Specified_Directory = '1' ;
myOutputPtr->Body_Attachment_Struct.Offset_Path_Name = 20 ;
myOutputPtr->Body_Attachment_Struct.Length_Format_Structure = 20;
myOutputPtr->Body_Attachment_Struct.Total_Length = myOutputPtr->Body_Attachment_Struct.Length_Format_Structure +
    strlen(myOutputPtr->Body_Attachment_Path_Name) ;
myOutputPtr->All_Body_Files.Total_Length = sizeof(myOutputPtr->All_Body_Files)
    + myOutputPtr->Body_Attachment_Struct.Length_Format_Structure;
myOutputPtr->All_Body_Files.Number_Stream_Files = 1;
memset(myOutputPtr->Body_Attachment_Struct.Reserved3,'\0',3) ;

/* Indicate an IFS file to attach to the Email */
strcpy ( myOutputPtr->Attachment_Path_Name, "/home/myAttachments/attach.txt" );
myOutputPtr->Attachment_Struct.Length_Path_Name = strlen(myOutputPtr->Attachment_Path_Name ) ;
myOutputPtr->Attachment_Struct.Use_Specified_Directory = '0' ;
myOutputPtr->Attachment_Struct.Offset_Path_Name = 20 ;
myOutputPtr->Attachment_Struct.Length_Format_Structure = 20;
myOutputPtr->Attachment_Struct.Total_Length = myOutputPtr->Attachment_Struct.Length_Format_Structure
    + strlen(myOutputPtr->Attachment_Path_Name) ;
myOutputPtr->Attachments.Total_Length = sizeof(myOutputPtr->Attachments)
    + myOutputPtr->Attachment_Struct.Length_Format_Structure;
myOutputPtr->Attachments.Number_Stream_Files = 1;
memset(myOutputPtr->Attachment_Struct.Reserved3,'\0',3) ;

/* PDF Encryption */
strcpy(myOutputPtr->PDF_Encryption.PDF_Owner_Password, "masterpwd", 9);
strcpy(myOutputPtr->PDF_Encryption.PDF_User_Password, "userpwd", 7);
myOutputPtr->PDF_Encryption.PDF_Printing[0] = '1';
myOutputPtr->PDF_Encryption.PDF_Changing_Document[0] = '1';
myOutputPtr->PDF_Encryption.PDF_Copy[0] = '1';
myOutputPtr->PDF_Encryption.PDF_Encryption_Level[0] = '1';
myOutputPtr->PDF_Encryption.PDF_Content_Access_Enablement[0] = '1';
myOutputPtr->PDF_Encryption.PDF_Comment_Changing[0] = '1';

```

```

myOutputPtr->PDF_Encryption.PDF_Document_Assembly[0]          = '1';

/* PDF Spooled File */

myOutputPtr->Exit_Output_Struct.PDF_Spooled_File_Disposition[0] = '1';
strcpy(myOutputPtr->PDF_SpoolFile.Output_Queue_Name, "MYOUTQ",10);
strcpy(myOutputPtr->PDF_SpoolFile.Output_Queue_Library, "MYOUTQLIB",10);
strcpy(myOutputPtr->PDF_SpoolFile.User_Data,"",10);
memset( myOutputPtr->PDF_SpoolFile.User_Defined_Data, ' ',255);
strcpy(myOutputPtr->PDF_SpoolFile.Spooled_File_Name,"MYSPLF", 10);

/* AFP Spooled File */

myOutputPtr->Exit_Output_Struct.AFP_Spooled_File_Disposition[0] = '1';
strcpy(myOutputPtr->AFP_SpoolFile.Output_Queue_Name, "MYOUTQ",10);
strcpy(myOutputPtr->AFP_SpoolFile.Output_Queue_Library, "MYOUTQLIB",10);
strcpy(myOutputPtr->AFP_SpoolFile.User_Data,"",10);
memset( myOutputPtr->AFP_SpoolFile.User_Defined_Data, ' ',255);
strcpy(myOutputPtr->AFP_SpoolFile.Spooled_File_Name,"MYSPLF", 10);

/*PDF Stream File */

myOutputPtr->Exit_Output_Struct.PDF_Stream_File_Disposition[0] = '1';
strcpy(myOutputPtr->PDF_File_Path, "~/home/mypdfpath/my.pdf");
myOutputPtr->Exit_Extension_Area.Length_PDF_File_Path = strlen(myOutputPtr->PDF_File_Path);

/* Authority for PDF Stream File */

strcpy(myOutputPtr->PDF_File_Authority, "*RWX",4);
myOutputPtr->Exit_Extension_Area.Length_PDF_File_Authority = 4;

/*PDF E-mail attachment File Name */

myOutputPtr->Exit_Output_Struct.PDF_Stream_File_Disposition[0] = '1';
strcpy(myOutputPtr->PDF_File_Name, "email.pdf");
myOutputPtr->Exit_Extension_Area.Length_PDF_File_Name = strlen(myOutputPtr->PDF_File_Name);

return 0;
}

```

---

## PDF Mapping Program in RPG

This is a template for a mapping program, it is an illustration intended to explain how to use a mapping program. Before using this program, you must customize it for your environment. A mapping program is an exit program that helps you customize the PDF subsystem. For information about using the PDF subsystem, see Chapter 4, "Using the PDF Subsystem," on page 59. For information about the exit program, see Appendix B, "Mapping Program," on page 177.

```

D INPUTDS          DS
D  JOBNAM          1      26
D  SPLFID          27     36
D  SPLNO           37     40B 0
D  MAILTAG         41     290
D  PDFFILE         291    630
D  SVRTYPE         631    631
D  RES1            632    632
B  D  PATHCCSID    633    636B 0
D  SENDER          637    646
D  USRDTA          647    656
D  SYSNAME         657    664
D  TIMESTMP        665    672
D  OUTQ            673    682
D  OUTQLIB         683    692
D  MAPOBJ          693    702
D  MAPOLIB         703    712
D  FORMTYPE        713    722
D*****

```

D	OUTDS	DS		
D	MAILDISP		1	1
D	CALLAGIN		2	2
D	RES2		3	4
D	MSGLEN		5	8B 0
D	ADDRLEN		9	12B 0
D	MSGTEXT		13	267
D	RES3		268	268
D	EXTOFF		269	272B 0
D	CCSID		273	276B 0
D	STMFDISP		277	277
D	SPLFDISP		278	278
D	ERR		279	279
D	RES4		280	287
D	ADDRESS		288	543
D*	EXTENSION AREA			
D	EXTLEN		544	547B 0
D	SUBOFF		548	551B 0
D	SUBLEN		552	555B 0
D	RPLYOFF		556	559B 0
D	RPLYLEN		560	563B 0
D	CCOFF		564	567B 0
D	CCLLEN		568	571B 0
D	BCCOFF		572	575B 0
D	BCCLLEN		576	579B 0
D	BDYPTHOFF		580	583B 0
D	DIRPTHOFF		584	587B 0
D	DIRPTHLEN		588	591B 0
D	ATTPTHOFF		592	595B 0
D*	NEW FOR V5R3			
D	NEWPTHOFF		596	599B 0
D	NEWPTHLEN		600	603B 0
D	NEWOBJOFF		604	607B 0
D	NEWOBJLEN		608	611B 0
D	PUBAUTOFF		612	615B 0
D	PUBAUTLEN		616	619B 0
D	PDFQOFF		620	623B 0
D	PDFQLEN		624	627B 0
D	AFPQOFF		628	631B 0
D	AFPQLEN		632	635B 0
D	ENCRYPTOFF		636	639B 0
D	ENCRYPTLEN		640	643B 0
D*	DATA FOR EXTENSION			
D	EXTSUBJ		644	653
D	EXTRPLY		654	678
D	EXTBCC		679	703
D	EXTCC		704	728
D*	STREAM FILE FORMAT			
D	BDYLEN		729	732B 0
D	BDYNUMB		733	736B 0
D*	INDIVIDUAL STREAM FILE INFORMATION FORMAT FOR FIRST FILE			
D	BDYX1		737	740B 0
D	BDYY1		741	744B 0
D	BDYOFF1		745	748B 0
D	BDYPLEN1		749	752B 0
D	BDYUSE1		753	753
D	BDYRES1		754	756 0
D	BDYPTH1		757	772
D*	INDIVIDUAL STREAM FILE INFORMATION FORMAT FOR SECOND FILE			
D	BDYX2		773	776B 0
D	BDYY2		777	780B 0
D	BDYOFF2		781	784B 0
D	BDYPLEN2		785	788B 0
D	BDYUSE2		789	789
D	BDYRES2		790	792 0
D	BDYPTH2		793	808
D*	INDIVIDUAL STREAM FILE INFORMATION FORMAT FOR THIRD FILE			

```

D BDYX3          809    812B 0
D BDYY3          813    816B 0
D BDYOFF3       817    820B 0
D BDYPLEN3     821    824B 0
D BDYUSE3       825    825
D BDYRES3       826    828 0
D BDYPTH3       829    844
D DIRPTH        845    849
D NEWPTH        850    884
D NEWOBJ        885    909
D PUBAUT        910    934
D PDFQ          935   1239
D AFPQ         1240   1241
D ENCRYPT       1242   1312
D*
D INPUTLEN     DS         4
D OUTPUTLEN    DS         4
D OUTINFO      DS         4
D*****
C   *ENTRY      PLIST
C               PARM             INPUTDS
C               PARM             INPUTLEN
C               PARM             OUTDS
C               PARM             OUTPUTLEN
C               PARM             OUTINFO
C
C* Check whether there is enough buffer space for all of the data. Initially,
C* the buffer size is set to X'00000151'. If you are using all of the values,
C* you need the buffer size to be X'00000520'.
C   EVAL        OUTINFO = X'00000520'
C* If the space IBM passed to the exit pgm isn't as large as what is needed,
C* get out of the exit program and return the needed value to IBM program.
C* Otherwise, if there is enough space, set values to be returned.
C   OUTINFO     IFLE      OUTPUTLEN
C               CLEAR                    OUTDS
C* If mailtag is TAG001, then use the following data for email
C   MAILTAG     IFEQ      'TAG001'
C               EVAL      ADDRESS = '''joeibmer@us.ibm.com'''
C* Mail the file
C               EVAL      MAILDISP = '1'
C* Dont call this pgm again for this file
C               EVAL      CALLAGIN = '0'
C               EVAL      RES2 = X'0000'
C* Set up message
C               EVAL      MSGLEN = 255
C               EVAL      ADRLEN = 256
C               EVAL      MSGTEXT = 'did you get this?'
C               EVAL      RES3 = X'00'
C               EVAL      EXTOFF = 543
C               EVAL      CCSID = 0
C               EVAL      RES4 = X'000000000000000000000000'
C               EVAL      EXTLEN = 100
C* Set up subject
C               EVAL      SUBOFF = 643
C               EVAL      SUBLEN = 10
C               EVAL      EXTSUBJ = 'TESTING123'
C* Set up reply to addresses
C               EVAL      RPLYOFF = 652
C               EVAL      RPLYLEN = 25
C               EVAL      EXTRPLY = '''joe2@x'''
C* Set up BCC addresss
C               EVAL      BCCOFF = 677
C               EVAL      BCCLN = 25
C               EVAL      EXTBCC = '''joe3@y.c'''
C* Set up CC addresses
C               EVAL      CCOFF = 702
C               EVAL      CCLEN = 25

```

```

C          EVAL      EXTCC   = '''joe4@y.com'''
C* Set up a body file
C          EVAL      BDYPHOFF = 728
C          EVAL      BDYLEN  = 116
C          EVAL      BDYNUMB = 3
C          EVAL      BDYX1   = 36
C          EVAL      BDYY1   = 20
C          EVAL      BDYOFF1 = 20
C          EVAL      BDYPLEN1= 8
C* Set to use a directory with 1st body file
C* Dont use leading slash
C          EVAL      BDYUSE1 = '1'
C          EVAL      BDYRES1 = X'000000'
C          EVAL      BDYPTH1 = 'bdy1.htm'
C* Set up a 2nd body file
C          EVAL      BDYX2   = 36
C          EVAL      BDYY2   = 20
C          EVAL      BDYOFF2 = 20
C          EVAL      BDYPLEN2= 14
C* Dont use directory with 2nd body file
C          EVAL      BDYUSE2 = '0'
C          EVAL      BDYRES2 = X'000000'
C          EVAL      BDYPTH2 = '/dir2/bdy2.htm'
C* Set up a 3rd body file
C          EVAL      BDYX3   = 36
C          EVAL      BDYY3   = 20
C          EVAL      BDYOFF3 = 20
C          EVAL      BDYPLEN3= 8
C* Use directory with 3rd body file
C* Dont use leading slash
C          EVAL      BDYUSE3 = '1'
C          EVAL      BDYRES3 = X'000000'
C          EVAL      BDYPTH3 = 'bdy3.txt'
C* Set up the directory to use with body files
C          EVAL      DIRPHOFF = 844
C          EVAL      DIRPTHLEN = 5
C          EVAL      DIRPTH   = '/dir1'
C* Set error setting (match was found)
C          EVAL      ERR      = '0'
C* Set encryption settings
C          EVAL      ENCRYPTOFF = 1241
C          EVAL      ENCRYPTLEN = 71
C          EVAL      ENCRYPT   = 'masterpw '
C          EVAL      '+'
C          EVAL      '+userpw '
C          EVAL      '+'
C          EVAL      '+11111111'
C* Set new object name for mailing
C          EVAL      NEWOBJLEN = 11
C          EVAL      NEWOBJOFF = 884
C          EVAL      NEWOBJ   = 'NEWNAME.PDF'
C* Store the PDF file in a directory
C          EVAL      STMFDISP = '1'
C* Specify the directory and object name for the STMFed file
C          EVAL      NEWPHOFF = 849
C          EVAL      NEWPTHLEN = 23
C          EVAL      NEWPTH   = '/new/path/newobject.pdf'
C* Set public authority
C          EVAL      PUBAUTOFF = 909
C          EVAL      PUBAUTLEN = 3
C          EVAL      PUBAUT   = '*WX'
C* Spool the PDF file to an output queue
C          EVAL      SPLFDISP = '1'
C* Specify the output queue, library, USRDFNDA, new name, formtype
C          EVAL      PDFQOFF = 934
C          EVAL      PDFQLEN = 305
C          EVAL      PDFQ    = 'PATQ      PATLIB      NEWNAME '

```

```

C          + 'NEWUSRDATA NEW USRDFNDA      '
C          + '
C          + '
C          + '
C          + '
C          + '
C          + '
C          + '
C          + '
C          + 'NEWFORMTYP'
C* If not TAG001, set flag to reflect no match found
C          ELSE
C          EVAL      ERR = '1'
C          ENDIF
C          ENDIF
C          SETON
LR

```

---

## Code license disclaimer information

IBM grants you a nonexclusive copyright license to use all programming code examples from which you can generate similar function tailored to your own specific needs.

SUBJECT TO ANY STATUTORY WARRANTIES WHICH CANNOT BE EXCLUDED, IBM, ITS PROGRAM DEVELOPERS AND SUPPLIERS MAKE NO WARRANTIES OR CONDITIONS EITHER EXPRESS OR IMPLIED, INCLUDING BUT NOT LIMITED TO, THE IMPLIED WARRANTIES OR CONDITIONS OF MERCHANTABILITY, FITNESS FOR A PARTICULAR PURPOSE, AND NON-INFRINGEMENT, REGARDING THE PROGRAM OR TECHNICAL SUPPORT, IF ANY.

UNDER NO CIRCUMSTANCES IS IBM, ITS PROGRAM DEVELOPERS OR SUPPLIERS LIABLE FOR ANY OF THE FOLLOWING, EVEN IF INFORMED OF THEIR POSSIBILITY:

1. LOSS OF, OR DAMAGE TO, DATA;
2. DIRECT, SPECIAL, INCIDENTAL, OR INDIRECT DAMAGES, OR FOR ANY ECONOMIC CONSEQUENTIAL DAMAGES; OR
3. LOST PROFITS, BUSINESS, REVENUE, GOODWILL, OR ANTICIPATED SAVINGS.

SOME JURISDICTIONS DO NOT ALLOW THE EXCLUSION OR LIMITATION OF DIRECT, INCIDENTAL, OR CONSEQUENTIAL DAMAGES, SO SOME OR ALL OF THE ABOVE LIMITATIONS OR EXCLUSIONS MAY NOT APPLY TO YOU.

---

## Appendix D. Exit Points

When you install Infoprint Server, it registers two exit points. If these exit points are modified, Infoprint Server might not function properly. This appendix identifies the exit points that Infoprint Server registers and lists their default settings. To view and edit the registry information, use Work With Registry Information (WRKREGINF).

### QIBM\_QPQ\_TRANSFORM

To view and edit the registry information for this exit point, enter WRKREGINF FORMAT(XPDF0100) and then choose option 8 "Work with exit programs". This exit point contains these default values:

Table 26. QIBM\_QPQ\_TRANSFORM Default Values

Exit Program	Exit Program Number	Library	Exit program data length	Exit program data
QIPSINIT	9974	QIPS	11	IPDS PDF

### QIBM\_QIMG\_TRANSFORMS

To view and edit the registry information for this exit point, enter WRKREGINF FORMAT(XFRM0100) and then choose option 8 "Work with exit programs". This exit point contains these default values:

Table 27. QIBM\_QIMG\_TRANSFORMS Default Values

Exit Program	Exit Program Number	Library	Exit program data length	Exit program data
QXTRCLIENT	5380	QIPS	16	PCL <sup>1</sup> AFPDS <sup>2</sup>
QXTRCLIENT	5381	QIPS	16	PS <sup>1</sup> AFPDS <sup>2</sup>
QXTRCLIENT	5382	QIPS	16	PDF <sup>1</sup> AFPDS <sup>2</sup>

#### Notes:

1. Eight bytes long, starting on byte 0.
2. Eight bytes long, starting on byte 7.





---

## Notices

This information was developed for products and services offered in the U.S.A.

IBM may not offer the products, services, or features discussed in this document in other countries. Consult your local IBM representative for information on the products and services currently available in your area. Any reference to an IBM product, program, or service is not intended to state or imply that only that IBM product, program, or service may be used. Any functionally equivalent product, program, or service that does not infringe any IBM intellectual property right may be used instead. However, it is the user's responsibility to evaluate and verify the operation of any non-IBM product, program, or service.

IBM may have patents or pending patent applications covering subject matter described in this document. The furnishing of this document does not give you any license to these patents. You can send license inquiries, in writing, to:

IBM Director of Licensing  
IBM Corporation  
500 Columbus Avenue  
Thornwood, NY 10594-1785  
U.S.A.

For license inquiries regarding double-byte (DBCS) information, contact the IBM Intellectual Property Department in your country or send inquiries, in writing, to:

IBM World Trade Asia Corporation  
Licensing  
2-31 Roppongi 3-chome, Minato-ku  
Tokyo 106, Japan

**The following paragraph does not apply to the United Kingdom or any other country where such provisions are inconsistent with local law:**

INTERNATIONAL BUSINESS MACHINES CORPORATION PROVIDES THIS PUBLICATION "AS IS" WITHOUT WARRANTY OF ANY KIND, EITHER EXPRESS OR IMPLIED, INCLUDING, BUT NOT LIMITED TO, THE IMPLIED WARRANTIES OF NON-INFRINGEMENT, MERCHANTABILITY OR FITNESS FOR A PARTICULAR PURPOSE. Some states do not allow disclaimer of express or implied warranties in certain transactions, therefore, this statement may not apply to you.

This information could include technical inaccuracies or typographical errors. Changes are periodically made to the information herein; these changes will be incorporated in new editions of the publication. IBM may make improvements and/or changes in the product(s) and/or the program(s) described in this publication at any time without notice.

Any references in this information to non-IBM Web sites are provided for convenience only and do not in any manner serve as an endorsement of those Web sites. The materials at those Web sites are not part of the materials for this IBM product and use of those Web sites is at your own risk.

IBM may use or distribute any of the information you supply in any way it believes appropriate without incurring any obligation to you.

Licensees of this program who wish to have information about it for the purpose of enabling: (i) the exchange of information between independently created programs and other programs (including this one) and (ii) the mutual use of the information which has been exchanged, should contact:

IBM Corporation  
Mail Drop 001W  
Boulder, CO 80301  
U.S.A.

Such information may be available, subject to appropriate terms and conditions, including in some cases, payment of a fee.

The licensed program described in this information and all licensed material available for it are provided by IBM under terms of the IBM Customer Agreement, IBM International Program License Agreement, or any equivalent agreement between us.

Information concerning non-IBM products was obtained from the suppliers of those products, their published announcements or other publicly available sources. IBM has not tested those products and cannot confirm the accuracy of performance, compatibility or any other claims related to non-IBM products. Questions on the capabilities of non-IBM products should be addressed to the suppliers of those products.

This information contains examples of data and reports used in daily business operations. To illustrate them as completely as possible, the examples include the names of individuals, companies, brands, and products. All of these names are fictitious and any similarity to the names and addresses used by an actual business enterprise is entirely coincidental.

#### COPYRIGHT LICENSE:

This information contains sample application programs in source language, which illustrate programming techniques on various operating platforms. You may copy, modify, and distribute these sample programs in any form without payment to IBM, for the purposes of developing, using, marketing or distributing application programs conforming to the application programming interface for the operating platform for which the sample programs are written. These examples have not been thoroughly tested under all conditions. IBM, therefore, cannot guarantee or imply reliability, serviceability, or function of these programs. You may copy, modify, and distribute these sample programs in any form without payment to IBM for the purposes of developing, using, marketing, or distributing application programs conforming to IBM's application programming interfaces.

If you are viewing this information softcopy, the photographs and color illustrations may not appear.

IBM grants you a nonexclusive copyright license to use all programming code examples from which you can generate similar function tailored to your own specific needs.

All sample code is provided by IBM for illustrative purposes only. These examples have not been thoroughly tested under all conditions. IBM, therefore, cannot guarantee or imply reliability, serviceability, or function of these programs.

All programs contained herein are provided to you "AS IS" without any warranties of any kind. The implied warranties of non-infringement, merchantability and fitness for a particular purpose are expressly disclaimed.

---

## Programming Interface Information

This Infoprint Server for iSeries: User's Guide documents intended Programming Interfaces that allow the customer to write programs to obtain the services of Infoprint Server for iSeries.

---

## Trademarks

The following are trademarks or registered trademarks of the IBM Corporation:

Advanced Function Presentation	IPDS
AFP	iSeries
AIX	MVS
AS/400	OfficeVision/400
Domino	OS/400
IBM	Print Services Facility
Infoprint	Redbooks
Intelligent Printer Data Stream	Websphere

The following terms appear in this publication and are trademarks of other companies:

Java and all Java-based trademarks are trademarks of Sun Microsystems, Inc. in the United States, other countries, or both.

Microsoft<sup>®</sup>, Windows, Windows NT, and the Windows logo are trademarks of Microsoft Corporation in the United States, other countries, or both.

Other company, product, and service names may be trademarks or service marks of others.



---

## Glossary

This glossary defines technical terms and abbreviations that are used in Infoprint Server documentation. If you do not find the term you are looking for, refer to the index of this publication or view *IBM Dictionary of Computing*, located at:  
<http://www.ibm.com/networking/nsg/nsgmain.htm>

Definitions reprinted from the *American National Dictionary for Information Processing Systems* are identified by the symbol (A) following the definition.

Definitions reprinted from a published section of the International Organization for Standardization (ISO) *Vocabulary—Information Processing* or from a published section of *Vocabulary—Office Machines* developed by Subcommittee 1, Joint Technical Committee 1, of the International Organization for Standardization and the International Electrotechnical Committee (ISO/IEC JTC1/SC1) are identified by the symbol (I) following the definition. Because many ISO definitions are also reproduced in the *American National Dictionary for Information Processing Systems*, ISO definitions may also be identified by the symbol (A).

Definitions that are specific to IBM products are so labeled—for example, “In SNA,” or “In the 3820 printer.”

These cross-references are used in this glossary:

- **Contrast with.** Refers to a term that has an opposite or substantively different meaning.
- **See.** Refers to multiple-word terms in which this term appears.
- **See also.** Refers to related terms that have similar, but not synonymous, meanings.
- **Synonymous with.** Appears in the commentary of a preferred term and identifies less desirable or less specific terms that have the same meaning.

### A

**Advanced Function Presentation (AFP).** A set of licensed programs, together with user applications, that use the all-points-addressable concept to print on

presentation devices. AFP includes creating, formatting, archiving, retrieving, viewing, distributing, and printing information. See *presentation device*.

**AFP.** See *Advanced Function Presentation*.

**AFP data stream.** A presentation data stream that is processed in the AFP environment. MO:DCA-P is the strategic AFP interchange data stream. IPDS is the strategic AFP printer data stream.

**AFP Viewer.** (1) Refers to the AFP Workbench Viewer and the AFP Viewer Plug-in. A Windows IBM-licensed PC product that lets you see AFP output in a WYSIWYP (what-you-see-is-what-you-print) format. (2) A Windows platform for the integration of AFP-enabling applications and services.

**AFPDS.** A term formerly used to identify the composed page; MO:DCA-P-based data stream that is interchanged in AFP environments.

**anchor point.** The point in a document that signals the beginning of a group of pages to CRTAFPDTA. After the anchor point, CRTAFPDTA adds indexing structured fields to delineate this group.

**architecture.** The set of rules and conventions that govern the creation and control of data types such as text, image, graphics, font, fax, color, audio, bar code, and multimedia.

**ASCII.** American National Standard Code for Information Interchange data encoding, which is the normal (default) type of data encoding in an AIX environment. Contrast with *EBCDIC*.

### B

**Bar Code Object Content Architecture™ (BCOCA).** An architected collection of control structures used to interchange and present bar code data.

**BCOCA.** See *Bar Code Object Content Architecture*.

**bin.** A paper supply on a cut-sheet printer. See also *cassette*.

**bitmap font.** See *raster font*.

### C

**carriage control character.** An optional character in an input data record that specifies a write, space, or skip operation.

**cassette.** In a cut-sheet printer, a movable enclosure for paper supply. See also *bin*.

**ccsid.** See *coded character set identifier*.

**character.** (1) A symbol used in printing. For example, a letter of the alphabet, a numeral, a punctuation mark, or any other symbol that represents information. (2) A byte of data.

**character set.** (1) A finite set of characters upon which agreement has been reached and that is considered complete for some purpose; for example, each of the characters in ISO Recommendation R646 "6- and 7-bit coded character sets for information processing interchange." (2) For page printers, the font library member that contains the character graphics and their descriptions.

**coded character set identifier.** The ID associated with a code page.

**coded font.** A font library member that associates a code page and a font character set. For double-byte fonts, a coded font associates more than one pair of code pages and font character sets.

**code page.** A font component that associates code points with character identifiers. A code page also identifies how undefined code points are handled.

**code point.** A one-byte code representing one of 256 potential characters.

**concatenate.** (1) To link together. (2) To join two character strings.

**concatenated data set.** In iSeries, a group of logically connected data sets that are treated as a single data set for the duration of a job step. See also *data set*.

**continuous forms paper.** A series of connected forms that feed continuously through a printing device. The connection between the forms is perforated to enable a user to tear them apart. Before printing, the forms are stacked, folded along the perforations. Contrast with *cut sheet paper*.

**control character.** A character that starts, changes, or stops any operation that affects recording, processing, transmitting, or interpreting data (such as carriage return, font change, and end of transmission).

**cut sheet paper.** Paper that is cut into separate sheets before it is printed on. Contrast with *continuous forms paper*.

## D

**data set.** A named set of records that are stored and processed as a unit. Synonym for *file*.

**data stream.** (1) All information (data and control commands) sent over a data link, usually in a single read or write operation. (2) A continuous stream of data elements being transmitted, or intended for transmission, in character or binary-digit form, using a defined format.

**default.** An attribute, value, or option that is assumed when none is explicitly specified. (I)

**disabled mechanism.** PSF support that enables jobs to print with alternative options if the printer selected for the job does not support a requested option. Contrast with *enabled*.

**document.** (1) A publication or other written material pertaining to a specific subject or related subjects. (2) In word processing, a collection of one or more lines of text that can be named and stored as a separate entity.

**double-byte coded font.** A font in which each character is defined by two bytes. The first byte defines a coded font section and the second defines a code point in that section. Double-byte coded fonts are needed for the support of languages that require more than 256 graphic characters. Two bytes are required to identify each graphic character. Kanji is printed by using a double-byte font. Contrast with *single-byte coded font*.

**download.** To transfer data from a processing unit to an attached device such as a microcomputer for processing.

**duplex printing.** Printing on both sides of a sheet of paper. Contrast with *simplex printing*.

## E

**e-mail address.** The address to which e-mail is sent. A valid e-mail address for Infoprint Server for iSeries is in the form *name@domain* and cannot have extra spaces.

**e-mail tag.** See *routing tag*

**EBCDIC.** Extended binary-coded decimal interchange code.

**electronic overlay.** A collection of constant data, such as lines, shading, text, boxes, or logos, that is electronically composed in the host processor and stored in a library. It can be merged with variable data during printing. Contrast with *page segment*.

**enabled.** (1) Pertaining to a state of the processing unit that allows certain types of interruption. (2) A condition of the printer (physically selected) in which the printer is available to the host processor for normal work. Contrast with *disabled mechanism*.

**end-user interface.** A method by which a customer can obtain the services of a product, for example, coding samples, commands and command lists. Not

every product has an end-user interface. Some products provide their services through programming interfaces, some provide services through a command line interface, and others provide services only to other products.

**escape character.** The control character X'2BD3' in a text-control sequence that indicates the beginning of the sequence and the end of any preceding text.

**euro.** The monetary unity of the European Monetary Union (EMU), introduced alongside national currencies on the first of January, 1999.

**EuroReady product.** A product is EuroReady if the product, when used in accordance with its associated documentation, is capable of correctly processing monetary data in the euro denomination, respecting the euro currency formatting conventions (including the euro sign). This assumes that all other products (for example, hardware, software, and firmware) that are used with this product are also EuroReady. IBM hardware products that are EuroReady might or might not have an engraved euro sign key on their keyboards.

**exception.** A condition that exists when the printer:

- Detects an invalid or unsupported command, order, control, or parameter value from the host
- Finds a condition of which the host system must be notified
- Detects a condition that requires the host system to resend data

**exception highlighting.** The markings placed on the printed page to indicate the location of an error in the data stream.

**execution.** The process of carrying out an instruction or instructions of a computer program by a computer.  
(I) (A)

**extended binary-coded decimal interchange code (EBCDIC).** A coded character set of 256 eight-bit characters.

## F

**font.** A family or assortment of characters of a given size and style; for example, 9-point Bodoni Modern.  
(A)

**font character set.** Synonym for *character set*.

**form.** A division of the physical medium. Multiple forms can exist on a physical medium. For example, a roll of paper might be divided by a printer into rectangular pieces of paper, each representing a form. An envelope is an example of a physical medium that has only one form. The IPDS architecture defines 4 types of form: cut-sheets, continuous forms, envelopes,

and computer output on microfilm. Each type of form has a top edge, a front side, and a back side.  
Synonymous with *sheet*.

**format.** (1) A specified arrangement of such things as characters, fields, and lines, usually used for displays, printouts, or files. (2) To arrange such things as characters, fields, and lines. (3) To prepare a document for printing in a specified format.

**form definition.** A resource that PSF uses to define the characteristics of a form. It specifies overlays to be used (if any), paper source (for cut-sheet printers), duplex printing, text suppression, the position of MO:DCA data on the form, and the number of copies and modifications of a page.

**fully resolved AFP.** See *portable AFP*.

## G

**GOCA.** See *Graphic Object Content Architecture*.

**Graphic Object Content Architecture (GOCA).** An architecture that provides a collection of graphics values and control structures used to interchange and present graphics data.

**GIF.** See *graphical image format*.

**graphical image format (GIF).** A digital format that is used to compress and transfer graphical information over computer networks. For example, GIF is a common format for graphical information on the Internet.

**group.** A named collection of sequential pages that form a logical subset of a document.

## H

**hardcopy.** (1) A copy of a display image that is generated on an output device such as a printer and can be carried away. (T) (2) A printed copy of machine output in a visually readable form, for example, printed reports, listings, documents, and summaries.

**hexadecimal.** Pertaining to a numbering system with base of 16. Valid numbers use the digits 0 through 9 and characters A through F, where A represents 10 and F represents 15.

**host font.** See *host resource*.

**host processor.** The processing unit to which the page printers are attached through a data-transfer interface.

**host resource.** A resource found in a system library, in a user library, or inline in the print data set.

**host system.** (1) A data processing system that prepares programs and operating environments for

another computer or controller. (2) The data processing system to which a network is connected and with which the system can communicate.

## I

**IBM-supplied mapping program.** A mapping program supplied with Infoprint Server and designed to be used with a map object that you create.

**image.** A pattern of toned and untoned pels that form a picture.

**image data.** A pattern of bits, with values of 0 and 1, that defines the pels in an image. (A 1-bit is a toned pel.)

**Image Object Content Architecture (IOCA).** An architected collection of constructs used to interchange and present images.

**indexing.** In CRTAFPDTA, a process of matching reference points within a file and creating structured field tags within the MO:DCA document and the separate index object file.

**indexing with data values.** The process of adding indexing tags to a MO:DCA document using data that is already in the document. This data must be consistently located in the same place in each group of pages.

**indexing with literal values.** The process of adding indexing tags to a MO:DCA document by assigning literal values as indexing tags. This is done when the document is not organized such that common data is located consistently throughout the document.

**index object file.** A file created by CRTAFPDTA that contains Index Element (IEL) structured fields, which identify the location of the tagged groups in the AFP file. The indexing tags are contained in the Tagged Logical Element (TLE) structured fields.

**Infoprint Manager.** A software component of IBM Infoprint Server for iSeries. Infoprint Manager handles the scheduling, archiving, retrieving, and assembly of a PCL, PDF, or PostScript to AFP transform job and its related resource files.

**IOCA.** See *Image Object Content Architecture*.

**initialize.** (1) In programming languages, to give a value to a data object at the beginning of its lifetime. (I) (2) To set counters, switches, addresses, or the contents of storage to zero or other starting values at the beginning of, or at prescribed points in the operation of, a computer routine. (A) (3) To prepare for use. For example, to initialize a diskette.

**inline.** The direction of successive characters in a line of text. Synonymous with *inline direction*.

**inline direction.** The direction of successive characters in a line of text.

**inline resource.** A resource contained in the print data set.

**input/output (I/O).** Pertaining to a device whose parts can perform an input process and an output process at the same time. (I)

**Intelligent Printer Data Stream (IPDS).** (1) The data stream generated by PSF to send to an IPDS page printer. (2) An all-points-addressable data stream that enables users to position text, images, and graphics at any defined point on a printed page.

**intelligent routing.** The ability to distribute output from the PDF subsystem in multiple ways, based on values specified in a mapping program.

**interface.** A shared boundary. An interface can be a hardware component used to link two devices. It can also be a portion of storage or registers accessed by two or more computer programs.

**I/O.** Input/output.

**IPDS.** See *Intelligent Printer Data Stream*.

**iSeries Information Center.** A Web site that contains technical information about the iSeries, including instructions for completing tasks and informational topics. You can access the version of the Information Center corresponding to the version of the operating system you have installed. To access the Information Center, go to

<http://www.ibm.com/servers/eserver/series/infocenter>

.

## J

**JPEG.** A standard format for storing compressed true-color images. "JPEG" represents "Joint Photographic Experts Group."

**Joint Photographic Expert Group (JPEG).** The name of the committee that developed the JPEG standard format.

## L

**library.** A file or a set of related files, for example, a page definition library containing one or more page definition files.

**licensed program.** A utility that performs a function for the user and usually interacts with and relies upon system control programming or some other IBM-provided control program. A licensed program



contains logic related to the user's data and is usable or adaptable to meet specific requirements.

**line data.** Data prepared for printing on a line printer such as an IBM 3800 Printing Subsystem Model 1. Line data is usually characterized by carriage control characters and table reference characters. Contrast with *MO:DCA*.

**line printer.** A device that prints a line of characters as a unit. (I) (A) Contrast with *page printer*.

**logical page.** A presentation space. One or more object areas or data blocks can be mapped to a logical page. A logical page is rectangular and has specifiable characteristics such as size, shape, orientation, and offset. Orientation and offset are specified relative to a coordinate system for the medium.

**logical page origin.** (1) The point on the logical page from which the positions of images, graphics, page overlays, and text with 0-degree inline direction are measured. (2) The point on the logical page represented by  $X_p=0$ ,  $Y_p=0$  in the  $X_p$  coordinate system.

## M

**macro.** Synonym for *macroinstruction*.

**macroinstruction.** An instruction that causes the execution of a predefined sequence of instructions.

**mail tag.** See *routing tag*

**map object.** An object that passes values to the IBM-supplied mapping program. It is used to customize the PDF subsystem without having to program a mapping program.

**mapping program.** An exit program written by a user that can be used to accomplish many tasks with the PDF subsystem. It can interpret routing tags, specify the subject of an e-mail, and add text to the beginning of each e-mail. If you are using an SMTP server to send the e-mail, it has additional capabilities. It can also specify carbon copy (cc) and blind carbon copy (bcc), and return-to e-mail addresses, a file to use as the body of the e-mail, and attachments.

The IBM-supplied mapping program is used with a map object.

**merged stream file.** See *portable AFP*.

**Microfilm device.** An output device that presents a hardcopy on microfilm.

**migration.** Activities that relate to the installation of a new version or release of a program to replace an earlier level. Completion of these activities ensures that the applications and resources on your system will function correctly at the new level.

**Mixed Object Document Content Architecture.** A strategic, architected, device-independent data stream used for interchanging documents.

**MO:DCA.** See *Mixed Object Document Content Architecture*.

**MO:DCA data.** Print data that has been composed into pages. Text-formatting programs such as DCF can produce composed text data that consists entirely of structured fields.

**MO:DCA data page.** A page of print data that consists entirely of structured fields.

**MO:DCA print data set.** A print data set that consists entirely of structured fields.

**MO:DCA-P.** Mixed Object Document Content Architecture for Presentation.

## N

**nested resource.** A resource mapped in an overlay.

**non-square pixels.** An image that has different resolutions in the X (horizontal) and Y (vertical) directions is said to have non-square pixels.

## O

**outline font.** A font technology in which the graphic character shapes are represented by a series of mathematical expressions that define the outer edges of the strokes. The resulting graphic character shapes can be either solid or hollow. Outline fonts can be scaled (sized) to any size. The IBM outline font character sets have a prefix of CZ. Contrast with *raster font*.

**overlay.** See *electronic overlay*.

## P

**page.** A collection of data that can be printed on a physical sheet of paper.

**page printer.** Any of a class of printers that accepts MO:DCA-P pages. Contrast with *line printer*.

**page segment.** A resource containing MO:DCA data and images, prepared before formatting and included as part of the input for a print job.

**parameter.** (1) A variable that is given a constant value for a specified application and that may denote the application. (I) (A) (2) An item in a menu for which the user specifies a value or for which the system provides a value when the menu is interpreted. (3) Data passed between programs or procedures.

**PDF mapping program.** See *PDF mapping program*.

**PDF subsystem.** A component of Infoprint Server that converts a spooled file to PDF. It then passes the PDF to PSF for i5/OS. PSF for i5/OS then stores the PDF file as a stream file, spools it on an output queue, or e-mails it. You do not need a PSF for i5/OS license to use the PDF subsystem.

**pel.** See *picture element*.

**physical medium.** A physical entity on which information is presented. Examples of physical media are display screens, paper, foils, microfilm, and labels.

**picture element (pel).** An element of a raster pattern about which a toned area on the photoconductor might appear. See also *raster pattern*.

**pitch.** A unit of measurement for the width of a printed character, reflecting the number of times a graphic character can be set in 1 linear inch. For example, 10-pitch has 10 graphic characters per inch. Contrast with *point*.

**point.** A unit of measurement about 1/72 of an inch. It used to measure the height of a font. Contrast with *pitch*.

**point size.** The height of a font in points.

**presentation device.** A device that produces character shapes, graphics pictures, images, or bar code symbols on a physical medium. Examples of physical media are display screens, paper, foils, microfilm, and labels.

**portable AFP.** AFP data packaged with the resources necessary for printing and indexing information, if any exists.

**print job.** The data that a user submits to PSF for printing.

**Print Services Facility (PSF).** PSF is a licensed IBM program that manages and controls the input data stream and output data stream that required by supported IBM page printers. PSF manages printer resources such as fonts, images, electronic forms, form definitions, and page definitions, and provides error recovery for print jobs.

When printing line data, PSF supports external formatting by using page definitions and form definitions. This external formatting extends page printer functions such as electronic forms and use of typographic fonts without any change to applications programs.

**printable area.** The area on a sheet of medium on which print can be placed.

**printer.** A presentation device that produces hardcopy output. See *presentation device*.

**processor.** In a computer, a functional unit that interprets and executes instructions. (I) (A)

**PSF.** See *Print Services Facility*.

## R

**raster font.** A font technology in which the graphic characters are defined directly by the raster bit map. Contrast with *outline font*.

**raster pattern.** A series of picture elements (pels) in scan lines to form an image. See also *page segment*.

**record format line data.** A form of line data where each record is preceded by a 10-byte identifier.

**resolution.** In computer graphics, a measure of the sharpness of an image. It is expressed as the number of lines and columns on the display screen or the number of pels per unit of linear measure.

**resource.** (1) A collection of printing instructions that are used by PSF in addition to the print data set to produce printed output. PSF resources include coded fonts, font character sets, code pages, page segments, overlays, form definitions, and page definitions. (2) Any source of aid that is used for performing a task, such as disk storage space, computer processing time, and communication lines.

**resource name.** The name under which a resource object is stored, the first two characters of which indicate the resource type:

<b>X0-XG,XZ</b>	Coded font
<b>T1</b>	Code page
<b>C0-CG,CZ</b>	Font character set
<b>S1</b>	Page segment
<b>F1</b>	Form definition
<b>P1</b>	Page definition
<b>O1</b>	Overlay
<b>H1</b>	Recommended for microfilm

**rotation.** The number of degrees a graphic character is turned relative to the page coordinates.

**routing tag.** A keyword or valid e-mail address (in the form *name@domain*) used with the PDF subsystem. If the routing tag is a keyword, it must be mapped to one or more valid e-mail addresses or other information by a user-defined mapping program.

## S

**segment.** Synonym for *page segment*.

**sheet.** A division of the physical medium on which data is presented. The IPDS architecture defines 4 types of sheet: cut-sheet forms, continuous forms, envelopes, and computer output on microfilm. Each sheet has a front side and a back side. Some types of media consist of multiple sheets; for example, a roll of continuous forms can be divided at the perforations into rectangular sheets. Each sheet usually has carrier or

tractor-feed strips, also. Microfilm is another example of a medium comprising multiple sheets, whereas an envelope has only one sheet. Synonymous with *form*.

**simplex printing.** Printing on one side of the paper. Contrast with *duplex printing*.

**single-byte coded font.** A font in which the characters are defined by a one-byte code point. A single-byte coded font contains only one coded font section. Contrast with *double-byte coded font*.

**spooled file.** A file created by an application program that contains the actual information to be printed. It also contains some of the data that controls the format of the printing.

**structured field.** A self-identifying, variable-length, bounded record that can have a content portion that provides control information, data, or both.

**syntax.** The rules and keywords that govern the use of a programming language.

## T

**table reference characters (TRC).** An optional control character in an input record that identifies the font with which the record is to be printed. The table reference character corresponds to a font number defined in a page definition font list or to the order of font names listed in the CHARS parameter in the JCL.

**tag.** A type of structured field that is used to index an AFP document. Tags associate an index attribute - value pair with a specific page or group of pages in a document.

**Tag Image File Format (TIFF).** A graphic file format used to store and exchange scanned images; compatible with a number of personal computing platforms.

**terminate.** (1) To stop the operation of a system or device. (2) To stop execution of a program.

**text.** A graphic representation of information on an output medium. Text can consist of alphanumeric characters and symbols that are arranged in paragraphs, tables, columns, or other shapes.

**TIFF.** See *Tag Image File Format*.

**token ring.** A network configuration in which tokens are passed in a circuit from node to node. A node that is ready to send can capture the token and insert data for transmission.

**trace.** A record of the execution of a computer program. It exhibits the sequences in which the instructions were executed. (A)

**TRC.** See *table reference character*.

**trigger.** Data values for which CRTAFPDTA searches, to delineate the beginning of a new group of pages. The first trigger is then the anchor point from which CRTAFPDTA locates the defined index values. See *anchor point*.

## U

**upload.** (1) To transfer programs or data from a connected device, typically a personal computer, to a computer with greater resources. (T) (2) To transfer data from a device, such as a workstation or a microcomputer, to a computer. Contrast with *download*.

## V

**Viewer.** See *AFP Workbench Viewer*.

## X

**X-axis.** In printing, an axis perpendicular to the direction in which the paper moves through the printer. See also *Y-axis*.

**X-extent.** A measurement along the X-axis.

## Y

**Y-axis.** In printing, an axis parallel to the direction in which the paper moves through the printer. See also *X-axis*.

**Y-extent.** A measurement along the Y-axis.



---

## Bibliography

This bibliography lists the titles of publications containing additional information about Infoprint Server for iSeries, the i5/OS operating system, Advanced Function Presentation, and related products.

The titles and order numbers may change from time to time. To verify the current title or order number, consult your IBM marketing representative.

You can obtain many of the publications listed in this bibliography from the IBM Publications Center:

<http://www.elink.ibm.link.ibm.com/public/applications/publications/cgibin/pbi.cgi>

Other information can be found in the iSeries Information Center.

---

### Infoprint Server

Publication	Order Number
<i>Infoprint Server for iSeries: User's Guide</i>	G544-5775-05
<i>Infoprint Server for iSeries: Introduction and Planning Guide</i>	G544-5774-03

---

### Advanced Function Presentation (AFP)

Publication	Order Number
<i>iSeries Guide to Output</i>	S544-5319-07
<i>Printing and Publishing Cluster Collection CD-ROM</i>	SK2T-2921

---

### Infoprint Designer

Publication	Order Number
<i>Infoprint Designer for iSeries: Getting Started</i>	G544-5773-03

---

### i5/OS

Publication	Order Number
<i>iSeries Guide to Output</i>	S544-5319-07
<i>CL Programming</i>	<i>CL Programming</i>
<i>Install, upgrade, or delete i5/OS and related software</i>	SC41-5120-09

---

## Printers

<b>Publication</b>	<b>Order Number</b>
<i>IBM Printing Systems: Printer Summary</i>	S544-5749
<i>IBM Printing Systems: Printer Information</i>	S544-5750

---

## Redbooks

<b>Publication</b>	<b>Order Number</b>
<i>IBM AS/400 Printing V</i>	SG24-2160
<i>IBM @server iSeries Printing VI: Delivering the Output of e-business</i>	SG24-6250

---

## TCP/IP

<b>Publication</b>	<b>Order Number</b>
<i>Internetworking with TCP/IP, Principles, Protocols, and Architecture</i>	SC31-6144
<i>TCP/IP Tutorial and Technical Reference</i>	GG24-3376
<i>TCP/IP Configuration and Reference</i>	SC41-5420-04

# Index

## Numerics

5.3 new function 6

## A

a parameter 44  
accessibility for PDF files 72  
accessing the PDF subsystem from iSeries  
  Access 67  
ACIF 11  
ACIF compared to CRTAFPDTA 37  
AFP respool  
  command flow 70  
  described 70  
  IPDS passthrough 71  
  steps to 70  
AFP, printing 147  
AFPCHARS parameter 17  
AFPOUTQ parameter 82  
APPRESPOOL 147  
AFPRSC keyword  
  errors when using 101  
APPSAVE parameter 82  
alg parameter 44  
anchor 22  
APIs  
  PDF map 103  
archiving  
  retrieving resources for 16  
attachments, mail parameter 127  
authorities for image transforms 43  
authorities needed for CRTAFPDTA 13  
authorities needed to transform PCL, PS,  
  or PDF data to AFP 161  
authority parameter, PDF map 105  
authority requirements for PDF  
  transform 63  
authority, PDF stream file parameter 136

## B

bar codes with the PDF subsystem 91  
bcc e-mail address, mail parameter 127  
bcc e-mail stream file, mail  
  parameter 128  
BCOCA objects with the PDF  
  subsystem 68  
BCOCA support in PDF subsystem 91  
body of e-mail, parameter 129

## C

C parameter 45  
calib parameter 45  
cc e-mail address, mail parameter 128  
cc e-mail stream file, mail parameter 128  
checking for non-delivery messages 156  
choice parameter 45  
clean parameter 45

cmp parameter 46  
color with the PDF subsystem 92  
command  
  CRTAFPDTA 9  
  xxxx2afp 39  
configuration file  
  xxxx2afp 42  
configuring an IPDS to PDF printer 64  
Create AFP Data  
  *See also* command  
  authorities needed 13  
  e-mail considerations 36  
  e-mailing the output 34  
  example of e-mailing output 35  
  examples 28  
  getting ready to use 13  
  group name 14  
  groups 14  
  indexing limitations 15  
  indexing with 14  
  indexing with CRTAFPDTA 29  
  indexing with data values 15  
  input data 9  
  inserting routing tags with 78  
  merging resources with data 28  
  output 9  
  overview 9  
  parameters 17  
    AFP characters (AFPCHARS) 17  
    Form definition (FORMDF) 17  
    From spooled file  
      (FROMSPLF) 18  
    Generate group names  
      (IDXGRPNAM) 19  
    Generate page names  
      (IDXPAGNAM) 20  
    Image output (IMAGEOUT) 23  
    Index code page identifier  
      (IDXCDEPAG) 18  
    Index field definition  
      (IDXTAGFLD) 21  
    Index tag definition (IDXTAG) 20  
    Index trigger definition  
      (IDXTRG) 22  
    Indexing page limit  
      (IDXPAGLMT) 19  
    Information for index file  
      (IDXOBJ) 19  
    Job name (JOB) 23  
    Page definition (PAGDFN) 24  
    Resource Data (RSCDTA) 24  
    Select index for group names  
      (IDXGRP) 18  
    Spooled file created (CRTDATE  
      ) 17  
    Spooled file number (SPLNBR) 25  
    System name (JOBSYSNAME) 23  
    To index stream file  
      (TOIDXSTMF) 25  
    To merged stream file  
      (TOMRGSTMF) 26

Create AFP Data (*continued*)  
  parameters (*continued*)  
    To resource stream file  
      (TORSCSTMF) 27  
    To stream file (TOSTMF) 27  
  retrieving resources with 16  
  searching for resources 16  
  syntax 11  
  viewing the output 33  
Create PDF map command 104  
creating a map entry to catch errors 138  
creating a map object 104  
creating a PSF configuration object 153  
crop parameter 46  
CRTAFPDTA 78  
  *See* Create AFP Data  
CRTAFPDTA compared to ACIF 36  
CRTDATE parameter 17

## D

data queue 95  
data transformation  
  halftoning 41  
  scaling 40  
DDS 76  
deactivating Transform Manager 167  
deleting a map object 143  
displaying a map object 142  
distributing PDF output 69

## E

e-mail  
  administrator address 71  
  enabling your i5/OS for 150  
  PDF output 69  
  sending 149  
  steps to send a PDF file 150  
  tasks 149  
  time stamp 157  
e-mail body, mail parameter 129  
e-mail error 98  
e-mail error messages 156  
e-mailing the CRTAFPDTA output 34  
editing your Windows path 43  
enabling your i5/OS to send e-mail 150  
encrypting PDF files 72  
encryption level, mail parameter 129  
ending Transform Manager 166  
environment variables  
  xxxx2afp 42  
error checking with the PDF  
  subsystem 92  
error codes for PDF mapping  
  program 198  
error messages, e-mail 156  
error recovery  
  AFPRSC keyword 101  
  blurry fonts 100

- error recovery (*continued*)
  - e-mail 98
  - font differences in PDF 100
  - image transforms 56
  - PDF orientation 100
  - PDF paper size 100
  - PDF subsystem 99
  - printing PDF 100
  - printing respooled AFP 101
  - respooling AFP 101
  - security violation 100, 101
- errors
  - catching with PDF map entry 138
- errors with map object 148
- examples
  - adding a PDF map entry 139
  - configuring Transform Manager 164
  - creating a map object 105, 144
  - e-mailing CRTAFPDТА output 35
  - editing a map object 144
  - end-to-end with map object 144
  - indexing with CRTAFPDТА 29
  - inserting routing tags with DDS 78
  - mapping program 80
  - mapping program in C 209
  - mapping program in RPG 212
  - merging resources with data 28
  - specifying a map object 144
  - specifying the IBM-supplied mapping program 144
  - starting and ending font
    - downloader 170
  - TIFF to AFP transform 55
  - using PDF subsystem to send
    - e-mail 66
- exit points 217
  - QIBM\_QIMG\_TRANSFORMS 217
  - QIBM\_QPQ\_TRANSFORM 217

## F

- F10 119, 125
- F6 119, 125
- find function with the PDF
  - subsystem 92
- fit parameter 47
- fixes x
- font considerations with the PDF
  - subsystem 92
- Font Downloader 169
- font mapping file 164
- font sieving 92
- force parameter 47
- form type parameter 112
- form type, AFP spooled file
  - parameter 126
- form type, map entry parameter 112
- form type, PDF spooled file
  - parameter 135
- FORMDF parameter 17
- FROMSPLF parameter 18

## G

- gcorr parameter 47
- GIF images with the PDF subsystem 68

- GIF to AFP transform
  - See* image transforms
- gif2afp
  - See* image transforms
- GOCA objects with the PDF
  - subsystem 68
- GOCA support in PDF subsystem 91
- group tags
  - See also* routing tag
  - inserting in the data 76

## H

- halftoning
  - xxxx2afp 41
- halftoning in image transforms 41

## I

- i5/OS command syntax viii
- i5/OS printing 1
- IDXCDEPAG parameter 18
- IDXGRP parameter 18
- IDXGRPNAM parameter 19
- IDXOBJ parameter 19
- IDXPAGLMT parameter 19
- IDXPAGNAM parameter 20
- IDXTAG parameter 20
- IDXTAGFLD parameter 21
- IDXTRG parameter 22
- image configuration object 166
- image transform
  - invoking 55
- image transforms
  - See also* image transforms
  - acknowledgments 57
  - authorities 43
  - configuration file 42
  - editing your Windows path 43
  - environment variables 42
  - error recovery 56
  - examples 55
  - halftoning 41
  - input to 54
  - installing 41
  - limitations 57
  - notes about command line 55
  - options and values 44
  - output 55
  - output from 40
  - overview 39
  - parameters 44
  - planning for 41
  - scaling 40
  - syntax 39
- IMAGEOUT parameter 23
- INACTTIMO parameter 170
- including images with the PDF
  - subsystem 68
- increatins the maximum memory setting
  - for Transform Manager 165
- index object file
  - defined 14
- index stream file 10
- indexing
  - limitations 15

- indexing anchor record 22
- indexing with CRTAFPDТА 14
- indexing with data values 15
- indexing with literal values 15
- Infoprint Designer for iSeries 174
- Infoprint Server
  - components 1
  - installing 7
  - introducing 1
  - transforming PCL, PDF, and PostScript data with 159
- Infoprint Server components
  - CRTAFPDТА 9
  - image to AFP transforms 39
  - overview of 1
  - PCL, PDF, and PostScript to AFP transform 159
- ink parameter 47
- input
  - CRTAFPDТА 11
  - image transform 54
- input to CRTAFPDТА 9
- inserting a routing tag in the input file 155
- inserting a routing tag in the printer file 154
- inserting a routing tag in the spooled file 154
- installing Infoprint Server 7
- installing the image transforms 41
- intelligent routing
  - from CRTAFPDТА 78
  - from DDS 76
  - inserting in data 76
  - inserting in the input file 155
  - inserting in the printer file 154
  - inserting in the spooled file 154
  - specifying 69
  - used with map object 104
  - where specified 104
  - with PDF subsystem 59
- inv parameter 47
- IOCA objects with the PDF
  - subsystem 68
- IOCA support in PDF subsystem 91
- iSeries Access 173
  - accessing the PDF subsystem 67
  - overview 173
- iSeries Access for Web 173
- iSeries Information Center ix

## J

- j parameter 48
- job logs 98
- job name, map entry parameter 113
- JOB parameter 23
- JOBSYSNAME parameter 23
- JPEG images with the PDF
  - subsystem 68
- JPEG to AFP transform
  - See* image transforms
- jpeg2afp
  - See* image transforms



## L

- l parameter 48
- limitations
  - indexing 15
- limitations of image transforms 57
- lut parameter 49

## M

- M parameter 49
- mail sender, mail parameter 132
- mail tag
  - See routing tag
- map entry
  - catching errors 138
  - example of adding 139
  - working with 106
- map entry 103
- map object
  - created on 5.2 144
  - creating 104
  - defined 60
  - deleting 143
  - displaying 142
  - end-to-end 144
  - error situations 148
  - example of creating 105
  - introduced 60
  - map entry 103
  - object type 103
  - overview 103
  - printing 142
  - segment entry 103
  - using 143
- mapping program
  - defined 60
  - details 177
  - distributing output with 193, 194
  - error codes 198
  - introduced 59
  - specifying encryption with 185, 195
  - specifying intelligent routing with 185, 193, 194
- mapping program template in C 209
- mapping program template in RPG 212
- master password, mail parameter 132
- merged stream file 10
- message text, mail parameter 132
- messages, non-delivery 156
- mp parameter 49
- ms parameter 49
- msf parameter 49

## N

- naming a PDF file 75
- new in 5.3 6
- new text, map entry parameter 117
- nomp parameter 49
- non-delivery messages 156
- nosniff parameter 49
- noterm parameter 50
- nov parameter 50

## O

- o parameter 50
- object container support in PDF subsystem 91
- object containers
  - errors when using 68
- object containers with the PDF subsystem 68
- options
  - xxxx2afp 44
- outbits parameter 50
- outcolor parameter 51
- output
  - file size from the PDF subsystem 93
  - from image transform 55
- output from CRTAFPDTA 9
- output from image transforms 40
- output queue, AFP spooled file parameter 126
- output queue, map entry parameter 113
- overview of CRTAFPDTA 9
- overview of image transforms 39
- overview of infoprint server components 2
- overview of Infoprint Server components 1
- overview of PDF subsystem 59

## P

- p parameter 51
- PAGDFN parameter 24
- page numbering with the PDF subsystem 94
- pagetype parameter 51
- paper parameter 51
- parameters
  - a 44
    - AFP spooled file, form type 126
    - AFP spooled file, output queue 126
    - AFP spooled file, spooled file 126
    - AFP spooled file, user data 126
    - AFP spooled file, user defined data 126
  - AFPOUTQ 82
  - AFPSAVE 82
  - alg 44
  - C 45
    - calib 45
    - choice 45
    - clean 45
    - cmp 46
    - crop 46
    - CRTAFPDTA 17
    - fit 47
    - force 47
    - gcorr 47
    - INACTTIMO 170
    - ink 47
    - inv 47
    - j 48
    - l 48
    - lut 49
    - M 49
      - Mail, attachments 127
      - Mail, bcc e-mail address 127

## parameters (continued)

- Mail, bcc e-mail stream file 128
- Mail, cc e-mail address 128
- Mail, cc e-mail stream file 128
- Mail, e-mail body 129
- Mail, encryption level 129
- Mail, mail sender 132
- Mail, master password 132
- Mail, message text 132
- Mail, PDF file name 133
- Mail, reply to e-mail address 133
- Mail, subject 133
- Mail, to e-mail address 134
- Mail, to e-mail stream file 134
- Mail, user password 135
- map entry, form type 112
- map entry, job name 113
- map entry, new text 117
- map entry, output queue 113
- map entry, PDF mapping action 113
- map entry, routing tag 114
- map entry, segmented file 114
- map entry, sequence 115
- map entry, spooled file 115
- map entry, text 116
- map entry, to sequence number 117
- map entry, user 116
- map entry, user data 116
- mp 49
- ms 49
- msf 49
- nomp 49
- nosniff 49
- noterm 50
- nov 50
- o 50
- outbits 50
- outcolor 51
- p 51
- pagetype 51
- paper 51
- PDF map 104, 109
- PDF map, authority 105
- PDF map, Text 'description' 105
- PDF spooled file, form type 135
- PDF spooled file, PDF output queue 135
- PDF spooled file, spooled file 135
- PDF spooled file, user data 136
- PDF spooled file, user defined data 136
- PDF stream file, authority 136
- PDF stream file, PDF stream file 137
- PDFADMIN 82
- PDFDEVTYPE 83
- PDFDIR 84
- PDFDTAQU 86
- PDFGEN 86
- PDFINCFNT 87
- PDFMAILSVR 87
- PDFMAP 87
- PDFMAPPGM 88
- PDFMULT 88
- PDFOUTQ 89
- PDFPPRDWR1 89
- PDFPPRDWR2 89
- PDFSENDER 90

- parameters (*continued*)
  - PORT 170
  - position to 109
  - PSF configuration object 82
  - r 52
  - respath 52
  - rot 52
  - scale 52
  - segment entry, PDF mapping
    - action 122
  - segment entry, routing tag 123
  - segment entry, text 124
  - segment entry, to routing tag 124
  - segmented file 109
  - sequence 109
  - sgcorr 53
  - sniff 49
  - term 50
  - thresh 53
  - v 50
  - w 53
  - wrkdir 54
  - x 54
  - xxx2afp 44
  - xxxx2afp 39
  - y 54
- password protecting PDF files 72
- PCL, PDF, and PostScript to AFP transform 159
  - adding fonts 164
  - authorities needed 161
  - configuration file 163
  - configuring Transform Manager 162
  - creating the work directory 161
  - customizing PDF to AFP transform 164
  - customizing Postscript to AFP transform 164
  - deactivating 167
  - ending Transform Manager 166
  - image configuration object 166
  - increasing the memory for input 165
  - initializing transform jobs 162
  - number of active transform jobs 162
  - overview 159
  - planning for 161
  - printer device description, setting up 166
  - reactivating 167
  - setting up the printer device
    - description 166
  - starting Transform Manager 166
  - syntax 160
  - system requirements 161
  - transforming data with 167
  - troubleshooting 171
  - using 167
  - using Font Downloader 169
- PDF
  - accessibility 130, 132
  - accessible 72
  - administrator 71
  - authority to 73
  - directory authority 74
  - distributing 69
  - e-mailing 69
  - encryption 72
  - PDF (*continued*)
    - generating multiple 69
    - intelligent routing 69
    - map object, creating 104
    - map object, deleting 143
    - map object, displaying 142
    - map object, examples 144
    - map object, panels 106
    - map object, printing 142
    - map object, using 143
    - mapping program 69
    - naming 75
    - password protection 72
    - storing as stream file 69
    - subsystem
      - mapping program 177
  - PDF conversion completion
    - notification 95
  - PDF file name, mail parameter 133
  - PDF map APIs 103
  - PDF map parameter 104, 109
  - PDF mapping action, map entry parameter 113
  - PDF mapping action, segment entry parameter 122
  - PDF mapping program
    - See* mapping program
  - PDF mapping table 107
  - PDF output queue, PDF spooled file parameter 135
  - PDF print errors 100
  - PDF stream file, PDF stream file parameter 137
  - PDF subsystem
    - accessible output 72
    - authority requirements 63
    - authorization to PDF output 73
    - bar codes 91
    - BCOCA objects 68, 91
    - color 92
    - configuring the device 64
    - copies 95
    - data queue 95
    - DDS keywords 94
    - default transform characteristics 62
    - directory authority 74
    - distributing output from 69
    - duplex information 94
    - encrypting output 72
    - error checking 92
    - error messages 98
    - error recovery 98
    - example 66
    - file permissions 84
    - find function 92
    - font considerations 92
    - form definition 94
    - GIF images 68
    - GOCA objects 68, 91
    - how do I... 68
    - including images 68
    - including object containers 68
    - inserting indexing tags 76
    - inserting routing tags 76
    - IOCA objects 68, 91
    - JPEG images 68
    - landscape 95
  - PDF subsystem (*continued*)
    - mapping program template in C 209
    - mapping program template in RPG 212
    - maximum number of pages 94
    - naming a PDF file 75
    - object containers 91
    - orientation 100
    - output file size 93
    - overview 59
    - page numbering 94
    - page size 94, 100
    - password protection 72
    - PDF administrator 71
    - PDF conversion completion
      - notification 95
    - planning for 63
    - printer features 94
    - printer file 94
    - printing considerations 94
    - related PSF configuration object
      - parameters 82
    - respooling as AFP 70
    - sample mapping program 80
    - security violation 100
    - setting up PSF configuration object 63
    - single page PDF images 68
    - specifying a PDF administrator 71
    - specifying directory authority 74
    - specifying encryption 72
    - specifying intelligent routing 69
    - specifying location for a PDF file 75
    - starting the writer 65
    - TIFF images 68
    - transforming data with 65
    - troubleshooting 99
    - unsupported IPDS functions 93
    - usage notes 91
    - using 59
    - vary the device on 65
    - viewing considerations 95
    - with iSeries Access 67
  - PDF to AFP transform
    - customizing 164
  - PDFADMIN parameter 82
  - PDFDEVTYPE parameter 83
  - PDFDIR parameter 84
  - PDFDTAQ parameter 86
  - PDFGEN parameter 86
  - PDFINCFNT parameter 87
  - PDFMAILSVR parameter 87
  - PDFMAP object type 103
  - PDFMAP parameter 87
  - PDFMAPPGM parameter 88
  - PDFMULT parameter 88
  - PDFOUTQ parameter 89
  - PDFPPRDWR1 parameter 89
  - PDFPPRDWR2 parameter 89
  - PDFSENDER parameter 90
  - planning for a PCL, PDF, or PostScript transform 161
  - planning for CRTAFPDTA 13
  - planning for image transforms 41
  - planning for the PDF subsystem 63
  - PORT parameter 170
  - position to parameter 109

- PostScript to AFP transform
  - customizing 164
- print data 118, 125
- print entry 118, 125
- printer device description for Transform Manager 166
- printer features with the PDF subsystem 94
- printing a map object 142
- printing considerations with the PDF subsystem 94
- program fixes x
- PSF configuration object, setting up 63
- publications, related 231

## Q

- QIBM\_QIMG\_TRANSFORMS 217
- QIBM\_QPQ\_TRANSFORM 217

## R

- r parameter 52
- reactivating Transform Manager 168
- registered exit points 217
  - QIBM\_QIMG\_TRANSFORMS 217
  - QIBM\_QPQ\_TRANSFORM 217
- related products 173
  - Infoprint Designer for iSeries 174
  - iSeries Access 173
  - iSeries Access for Web 173
- related publications 231
- related tasks 175
- reply to e-mail address, mail parameter 133
- resource stream file 9
- resources
  - how CRTAFPDTA searches for 16
- respath parameter 52
- respool
  - PDF output 69
- rot parameter 52
- routing tag 153
  - See also* routing tag defined 60
- routing tag, map entry parameter 114
- routing tag, segment entry parameter 123
- RSCDTA parameter 24

## S

- scale parameter 52
- scaling
  - xxx2afp 40
- scaling in image transformrs 40
- security violation 100, 101
- segment entry 103
- segmented file parameter 109
- segmented file, map entry parameter 114
- sending e-mail 149
- sequence parameter 109
- sequence, map entry parameter 115
- setting QUTCOFFSET 157
- setting the public authority level 73

- Setting up a POP3 client for a SNDDST sender 157
- setting up the i5/OS as a POP e-mail client 153
- sgcorr parameter 53
- single page PDF images with the PDF subsystem 68
- sniff parameter 49
- specifying authority to PDF directory 74
- SPLNBR parameter 25
- spooled file, map entry parameter 115
- spooled file, AFP spooled file parameter 126
- spooled file, PDF spooled file parameter 135
- starting and ending font downloader 170
- starting the writer 65
- starting Transform Manager 166
- stdout 55
- stream file
  - PDF 69
- subject, mail parameter 133
- syntax
  - CRTAFPDTA 11
    - explained viii
    - PCL to AFP transform 160
    - PDF to AFP transform 160
    - PostScript to AFP transform 160
    - xxx2afp 39
- syntax for xxx2afp commands 39
- system requirements to transform PCL, PS, or PDF data to AFP 161

## T

- tasks
  - checking for non-delivery messages 156
  - creating a PSF configuration object 153
  - e-mail CRTAFPDTA output 34
  - enabling your i5/OS to send e-mail 150
  - generating index tags 76
  - generating multiple PDF files 76
  - generating routing tags 76
  - indexing with CRTAFPDTA 14
  - planning for a PCL, PDF, or PostScript transform 161
  - planning for CRTAFPDTA 13
  - planning for image transforms 41
  - planning for the PDF subsystem 63
  - sending e-mail 149
  - setting QUTCOFFSET 157
  - Setting up a POP3 client for a SNDDST sender 157
  - setting up the i5/OS as a POP e-mail client 153
  - transforming image data to AFP 39, 54
  - turning a PC AFP resource into an i5/OS resource 175
  - Using AFP Manager to send e-mail 155
  - using CRTAFPDTA 9
  - Using iSeries Access to send e-mail 155

- tasks (*continued*)
  - using routing tags 153
  - using the PDF subsystem 59
- term parameter 50
- Text 'description' parameter, PDF map 105
- text, map entry parameter 116
- text, segment entry parameter 124
- threadsafe 127, 129, 137
- thresh parameter 53
- TIFF images with the PDF subsystem 68
- TIFF to AFP transform
  - See* image transforms
- tiff2afp
  - See* image transforms
- time stamp 157
- to e-mail address, mail parameter 134
- to e-mail stream file, mail parameter 134
- to routing tag, segment entry parameter 124
- to sequence number, map entry parameter 117
- TOIDXSTMF parameter 25
- TOMRGSTMF parameter 26
- TORSCSTMF parameter 27
- TOSTMF parameter 27
- Transform Manager feature, using 159
- Transform Manager, configuring 162
- Transform Manager, ending 166
- Transform Manager, starting 166
- transforming
  - GIF data to AFP 39
  - GIF data to PostScript 39
  - image data to AFP 39
  - image data to PostScript 39
  - JPEG data to AFP 39
  - JPEG data to PostScript 39
  - line data to AFP 9
  - PCL to AFP 159
  - PDF to AFP 159
  - PostScript to AFP 159
  - spooled file to PDF 59
  - TIFF data to AFP 39
  - TIFF data to PostScript 39
- transforming data with the PDF subsystem 65
- transforming image data to afp 54
- transforming PCL, PDF or PostScript data to AFP 167
- troubleshooting
  - AFPRSC keyword 101
  - blurry fonts 100
  - font differences in PDF 100
  - PCL to AFP transform 171
  - PDF orientation 100
  - PDF paper size 100
  - PDF subsystem 99
  - PDF to AFP transform 171
  - PostScript to AFP transform 171
  - printing PDF 100
  - printing respooled AFP 101
  - respooling AFP 101
  - security violation 100, 101
- turning a PC AFP resource into an i5/OS resource 175

## U

- unsupported IPDS functions with the PDF subsystem 93
- user data, AFP spooled file parameter 126
- user data, map entry parameter 116
- user data, PDF spooled file parameter 136
- user defined data, AFP spooled file parameter 126
- user defined data, PDF spooled file parameter 136
- user password, mail parameter 135
- user, map entry parameter 116
- using a map object 143
- using a map object created on OS/400 5.2 144
- using a PSF configuration object with PSF defined options 82
- using AFP manager to send e-mail 155
- using CRTAFPDATA to generate multiple PDF files 78
- using DDS 76
- using iSeries Access to send e-mail 155
- using routing tags 153
- using the PDF subsystem 59

## V

- v parameter 50
- varying the device ON 65
- viewing
  - retrieving resources for 16
- viewing considerations with PDF subsystem 95
- viewing output indexed with CRTAFPDATA 33

## W

- w parameter 53
- Windows command line notes 55
- Windows command syntax viii
- work directory, creating 161
- Work with PDF Map Entries
  - command 107
- working with PDF map entries 106
- wkdir parameter 54
- WRKPDFMAPE command
  - add map entry
    - form type parameter 112
    - job name parameter 113
    - output queue parameter 113
    - parameters 112
    - PDF mapping action parameter 113
    - routing tag parameter 114
    - segmented file parameter 114
    - sequence parameter 115
    - spooled file parameter 115
    - text parameter 116
    - user data parameter 116
    - user parameter 116
  - add map entry option 110
  - add segment entry 121

## WRKPDFMAPE command (continued)

- PDF mapping action
  - parameter 122
- routing tag parameter 123
- text parameter 124
- change map entry 116
  - form type parameter 112
  - job name parameter 113
  - output queue parameter 113
  - PDF mapping action parameter 113
  - routing tag parameter 114
  - segmented file parameter 114
  - sequence parameter 115
  - spooled file parameter 115
  - text parameter 116
  - user data parameter 116
  - user parameter 116
- change segment entry 124
  - PDF mapping action parameter 122
  - routing tag parameter 123
  - text parameter 124
- copy map entry 117
  - new text parameter 117
  - to sequence number parameter 117
- copy segment entry 124
  - to routing tag parameter 124
- display map entry 118
  - print data 118
  - print entry 118
- display segment entry 125
  - print data 125
  - print entry 125
- mapping action, AFP spooled file 126
  - form type parameter 126
  - output queue parameter 126
  - spooled file parameter 126
  - user data parameter 126
  - user defined data parameter 126
- mapping action, mail 127
  - attachments parameter 127
  - bcc e-mail addressparameter 127
  - bcc e-mail stream file parameter 128
  - cc e-mail address parameter 128
  - cc e-mail stream file parameter 128
  - e-mail body parameter 129
  - encryption level parameter 129
  - mail sender parameter 132
  - master passwordparameter 132
  - message text parameter 132
  - PDF file name parameter 133
  - reply to e-mail address parameter 133
  - subject parameter 133
  - to e-mail address parameter 134
  - to e-mail stream file parameter 134
  - user password parameter 135
- mapping action, PDF spooled file 135
  - form type parameter 135
  - PDF output queue parameter 135

## WRKPDFMAPE command (continued)

- mapping action, PDF spooled file (continued)
  - spooled file parameter 135
  - user data parameter 136
  - user defined data parameter 136
- mapping action, PDF stream file
  - authority parameter 136
  - PDF stream file parameter 137
- mapping action, stream file 136
- overview 107
- print map entry 119
- print segment entry 126
- remove map entry 118
- remove segment entry 124
- work with segments 120

## X

- x parameter 54
- xxxx2afp
  - See image transforms

## Y

- y parameter 54

---

# Readers' Comments — We'd Like to Hear from You

Infoprint Server for iSeries  
User's Guide  
Version 5, Release 4.0

Publication No. G544-5775-05

Overall, how satisfied are you with the information in this book?

	Very Satisfied	Satisfied	Neutral	Dissatisfied	Very Dissatisfied
Overall satisfaction	<input type="checkbox"/>	<input type="checkbox"/>	<input type="checkbox"/>	<input type="checkbox"/>	<input type="checkbox"/>

How satisfied are you that the information in this book is:

	Very Satisfied	Satisfied	Neutral	Dissatisfied	Very Dissatisfied
Accurate	<input type="checkbox"/>	<input type="checkbox"/>	<input type="checkbox"/>	<input type="checkbox"/>	<input type="checkbox"/>
Complete	<input type="checkbox"/>	<input type="checkbox"/>	<input type="checkbox"/>	<input type="checkbox"/>	<input type="checkbox"/>
Easy to find	<input type="checkbox"/>	<input type="checkbox"/>	<input type="checkbox"/>	<input type="checkbox"/>	<input type="checkbox"/>
Easy to understand	<input type="checkbox"/>	<input type="checkbox"/>	<input type="checkbox"/>	<input type="checkbox"/>	<input type="checkbox"/>
Well organized	<input type="checkbox"/>	<input type="checkbox"/>	<input type="checkbox"/>	<input type="checkbox"/>	<input type="checkbox"/>
Applicable to your tasks	<input type="checkbox"/>	<input type="checkbox"/>	<input type="checkbox"/>	<input type="checkbox"/>	<input type="checkbox"/>

Please tell us how we can improve this book:

Thank you for your responses. May we contact you?  Yes  No

When you send comments to IBM, you grant IBM a nonexclusive right to use or distribute your comments in any way it believes appropriate without incurring any obligation to you.

---

Name

---

Address

---

Company or Organization

---

---

Phone No.

---



Fold and Tape

Please do not staple

Fold and Tape



NO POSTAGE  
NECESSARY  
IF MAILED IN THE  
UNITED STATES

# BUSINESS REPLY MAIL

FIRST-CLASS MAIL PERMIT NO. 40 ARMONK, NEW YORK

POSTAGE WILL BE PAID BY ADDRESSEE

IBM Corporation  
Information Development  
IBM Printing Systems Division  
Department H7FE Building 004M  
Boulder, CO 80301-9817



Fold and Tape

Please do not staple

Fold and Tape





Program Number: 5722-IP1

Printed in USA

G544-5775-05





Spine information:



Infoprint Server for iSeries

Infoprint Server for iSeries: User's Guide

Version 5,  
Release 4.0